

Model 9600 3G/HD/SD Model 9600-XV 3G/HD/SD

Embedder, Disembedder and Data Inserter User Guide

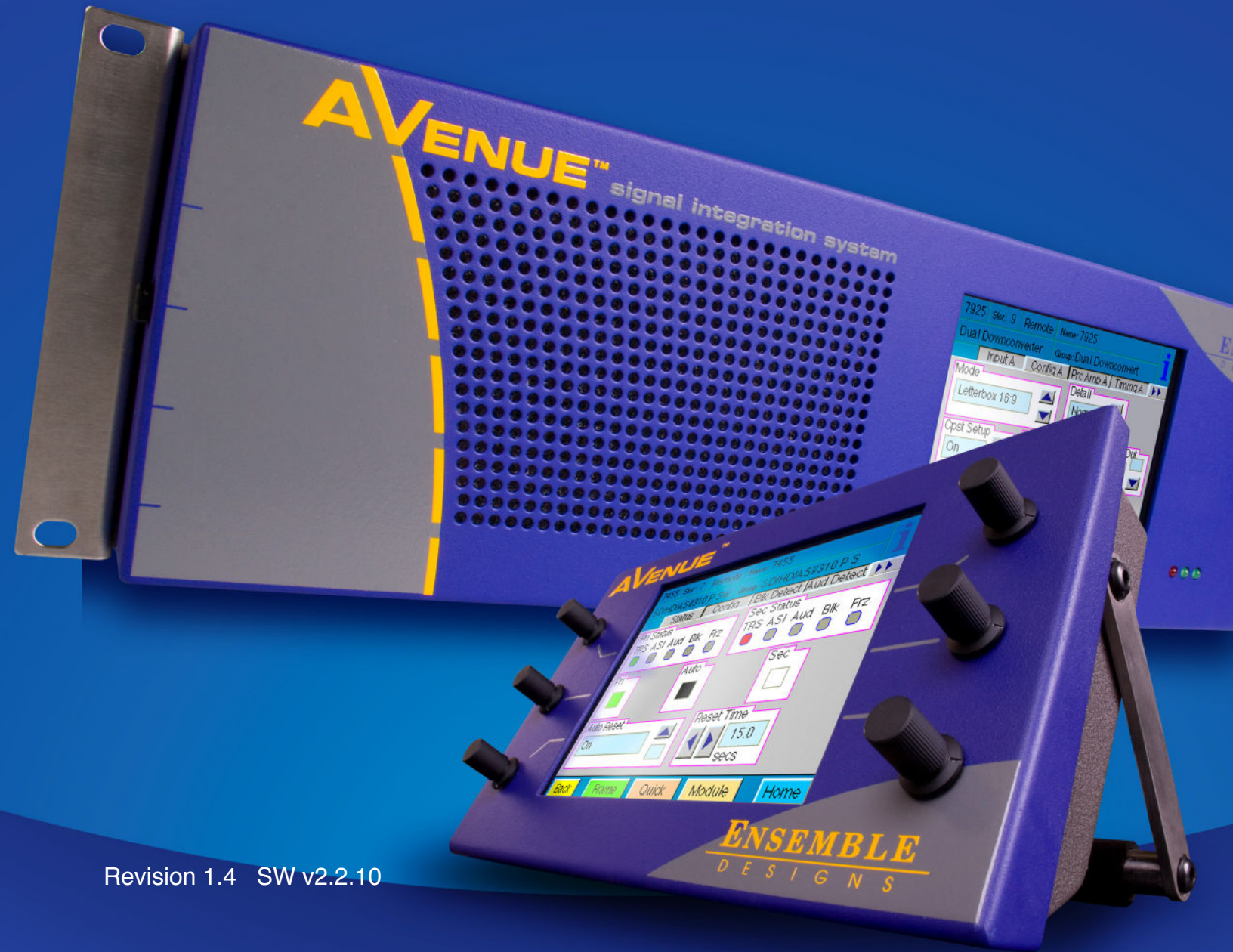

Revision 1.4 SW v2.2.10

ENSEMBLE

D E S I G N S

Purveyors of Fine Video Gear—Loved by Engineers Worldwide

Clearly, Ensemble wants to be in the broadcast equipment business. It's so rare anymore to find a company of this caliber that has not been gobbled up by a large corporation. They are privately held so they don't have to please the money people. They really put their efforts into building products and working with customers.

I'm really happy with the Avenue products and Ensemble's service, and even more important my engineers are happy. We've continued to upgrade the product and add more cards. We will be rebuilding our production control room and we will use Avenue again.

~ Don McKay, Vice President Engineering, Oregon Public Broadcasting

Who is Ensemble Designs?

By Engineers, For Engineers

In 1989, a former television station engineer who loved designing and building video equipment, decided to start a new company. He relished the idea of taking an existing group of equipment and adding a few special pieces in order to create an even more elegant ensemble. So, he designed and built his first product and the company was born.



Avenue frames handle 270 Mb/s, 1.5 Gb/s and 3 Gb/s signals, audio and MPEG signals. Used worldwide in broadcast, mobile, production, and post.

Focused On What You Need

As the company has grown, more former TV station engineers have joined Ensemble Designs and this wealth of practical experience fuels the company's innovation. Everyone at the company is focused on providing the very equipment you need to complete your ensemble of video and audio gear. We offer those special pieces that tie everything together so that when combined, the whole ensemble is exactly what you need.

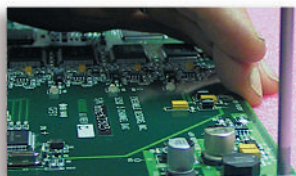

We're focused on processing gear— 3G/HD/SD/ASI video, audio and optical modules.

Notably Great Service for You

We listen to you – just tell us what you need and we'll do our best to build it. We are completely focused on you and the equipment you need. Being privately held means we don't have to worry about a big board of directors or anything else that might take attention away from real business. And, you can be sure that when you call a real person will answer the phone. We love this business and we're here to stay.



Come on by and visit us. Drop in for lunch and a tour!

Bricks and Mortar of Your Facility

The bricks and mortar of a facility include pieces like up/downconverters, audio embedders, video converters, routers, protection switches and SPGs for SD, HD and 3Gb/s. That's what we're focused on, that's all we do – we make proven and reliable signal processing and infrastructure gear for broadcasters worldwide, for you.



Shipped with care to television broadcasters and video facilities all over the world.



Contents

Module Overview	6
Configurable Mux or Demux	6
In-Line Processing	6
Dolby E and Dolby D/AC-3	6
LevelTrack™ Audio Loudness Control AGC and Compliance Options	6
Installation	7
Configuring the Analog Audio and Balanced Digital Data Jumper Connectors	7
Cabling for Avenue 9600	8
Cabling for Avenue 9600-XV	9
Functional Block Diagram for Avenue 9600	10
Functional Block Diagram for Avenue 9600-XV	11
Three Use Cases	12
Embedding	12
Disembedding	13
In-Line Processing	13
Module Configuration and Control	14
Avenue PC Option	14
Avenue Touch Screen Option	14
Front Panel Controls and Indicators for Avenue 9600	14
Front Panel Controls and Indicators for Avenue 9600-XV	15
Avenue PC Remote Configuration	16
9600 Avenue PC and Avenue Touch Screen Menus	16
Input Menu	16
Aud Stat Menu	18
Aud Cfg Menu	19
<i>Configuring Analog Audio Outputs and LevelTrack Audio Loudness Control AGC Software Option</i>	19
<i>Meter Mode</i>	19
<i>Meter Position</i>	19
<i>LKFS Average Time</i>	20

Mux Out Menu	21
<i>Determining which Audio Channels to Embed into the Outgoing SDI Signal</i>	21
<i>Placing the Encoder Output</i>	22
Mix 1:4, Mix 5:8, Mix 9:12, Mix 13:16 Menus	23
<i>Combinations of Input Channels</i>	23
<i>Out Bus Assignments</i>	24
<i>Automatic Gain Control (AGC)</i>	25
<i>Configuring Audio Output</i>	25
<i>Configuring Digital Audio Outputs</i>	25
In 1:4, In 5:8, In 9:12, In 13:16 Menus	26
<i>Using the In 1:4, In 5:8, In 9:12, In 13:16 Menus for Embedding</i>	27
<i>Using the In 1:4, In 5:8, In 9:12, In 13:16 Menus for Disembedding</i>	28
<i>Using the In 1:4, In 5:8, In 9:12, In 13:16 Menus for Disembedding (cont'd)</i>	29
<i>Using the In 1:4, In 5:8, In 9:12, In 13:16 Menus for In-line Processing</i>	30
<i>Using the In 1:4, In 5:8, In 9:12, In 13:16 Menus for In-line Processing (cont'd)</i>	31
<i>Audio Mode, Data Mode, Auto Mode</i>	32
BNC Status Menu	33
<i>Verifying BNC Status</i>	33
Aud AGC Menu	34
<i>AGC Master</i>	34
<i>Final Gain</i>	34
<i>Silence Limit</i>	34
<i>Target Level</i>	34
<i>Spread</i>	35
<i>Transition Time</i>	35
<i>Max Atten</i>	35
<i>Max Gain</i>	35
<i>Chart</i>	37
Decoder Menu	38
<i>Decoding Dolby E or Dolby D/AC-3</i>	38
Encoder Menu	40
<i>Encoding Dolby E or Dolby D/AC-3</i>	40
Memory Menu	42
<i>Saving and Recalling Multiple Configurations for the 9600 Module</i>	42
License Menu	43

Software Updating	44
Warranty and Factory Service	44
Specifications	45
Glossary	47

Module Overview

The 9600 module is a sixteen-channel audio embedder or disembedder for 1.5 Gb/s and 3 Gb/s high definition or 270 Mb/s standard definition video signals. Eight AES ports can be configured as inputs or outputs. Embedding and disembedding may be performed simultaneously. Additionally, the module supports four channels of analog audio.

Configurable Mux or Demux

When configured as a multiplexer, the 9600 has one serial digital video input and eight AES audio inputs. These eight AES streams are embedded into the video stream. AES inputs are sample rate converted, allowing the use of asynchronous audio. The output of the module is a digital stream that contains the original video signal and eight AES pairs, or sixteen channels.

When configured as a demultiplexer, audio signals present in the incoming video signal are extracted and delivered as standard AES digital audio streams.

The 9600 includes a sixteen-channel audio mixer. The channel swap and shuffle capability allows you to completely rearrange and remix audio channels. It provides precise control over audio level, with up to 12 dB of gain to compensate for low level sources. Delay is adjustable up to one second.

In-Line Processing

Because the 9600 has simultaneous disembedding and embedding, it is an in-line processor for embedded audio. It can take embedded content, adjust levels and remap channels, and deliver it to the output as an embedded signal.

Dolby E and Dolby D/AC-3

The 9600 can be fitted with Dolby E and Dolby D/AC-3 encoding and decoding options. The 7615 decoding option can be fed from either an AES input or an AES stream disembedded from the incoming SDI signal. The resulting discrete surround signals are then selectable as inputs to the sixteen-channel mixer/shuffler.

The 7630 Dolby encoder is fed from selected outputs of the sixteen-channel mixer/shuffler. The resulting encoded bitstream can be output on an AES output and embedded into the SDI output.

Additionally, the 9600 fully supports embedding and disembedding of encoded multi-channel bitstreams such as Dolby D/AC-3 and Dolby E.

LevelTrack™ Audio Loudness Control AGC and Compliance Options

The 9670 LevelTrack™ Audio Loudness Control Automatic Gain Control can be added as an option. LevelTrack provides control for keeping audio levels consistent in program material. The 9690 Audio Compliance and Monitoring Software can be added for compliance verification and archiving.

The 9600 can be configured locally or controlled and configured remotely with Avenue Touch Screens, Express Panels, or Avenue PC Software. Alarm generation, configurable user levels, module lockout, and customizable menus are included in the Avenue Control System.

Installation

Plug the 9600 module into any one of the slots in the 3RU frame or any slot (except slot 3) in the 1RU frame. Install the plastic overlay provided onto the corresponding group of rear BNC connectors associated with the module location. Note that the plastic overlay has an optional adhesive backing for securing it to the frame. Use of the adhesive backing is only necessary if you would like the location to be permanent and is not recommended if you need to change module locations. This module may be hot-swapped (inserted or removed) without powering down or disturbing performance of the other modules in the system.

Configuring the Analog Audio and Balanced Digital Data Jumper Connectors

Before you can use the 15-pin D connector for analog audio out, analog audio in, or digital, you must first install analog audio and balanced digital data jumper connectors onto the 9600 board. There are eight connectors (four pairs) that map to the 15-pin D connector. Each connector has three possible configurations— analog out, analog in, and digital.

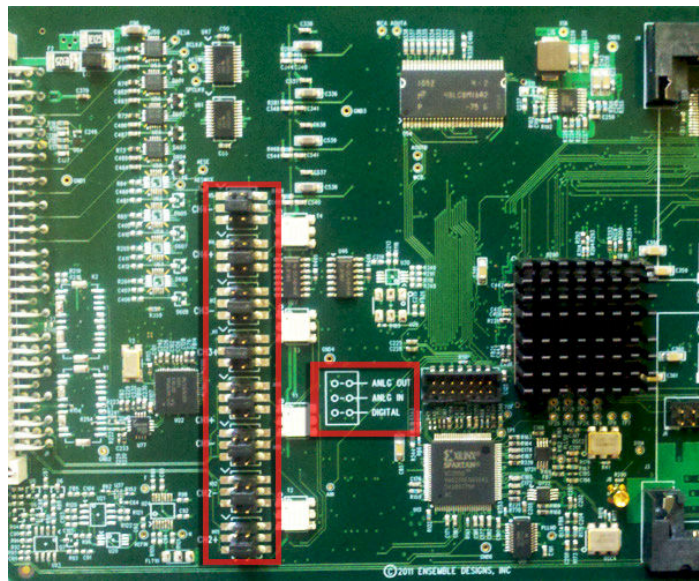
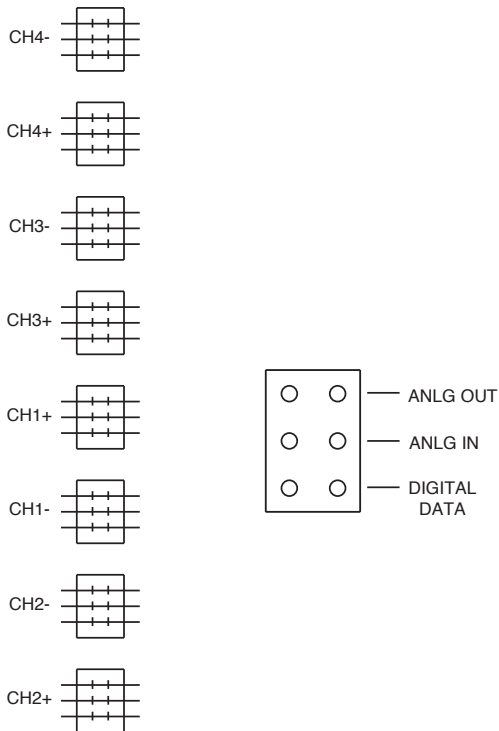

Note the portion of the board pictured above (outlined in red) that resembles the illustration to the left.

The illustration shown to the left reflects the placement of the connectors on the 9600 board (shown in the photograph on the right) for channels 1 through 4. The positive and negative connectors for each channel are indicated on the board.

For each of the eight connectors, use the jumper to connect the top pair for analog audio out, the middle pair for analog audio in, and the lower pair for digital data.

Cabling for Avenue 9600

Refer to the 3RU and 1RU backplane diagrams of the module below for cabling instructions. Note that unless stated otherwise, the 1RU cabling explanations are identical to those given in the 3RU diagram.

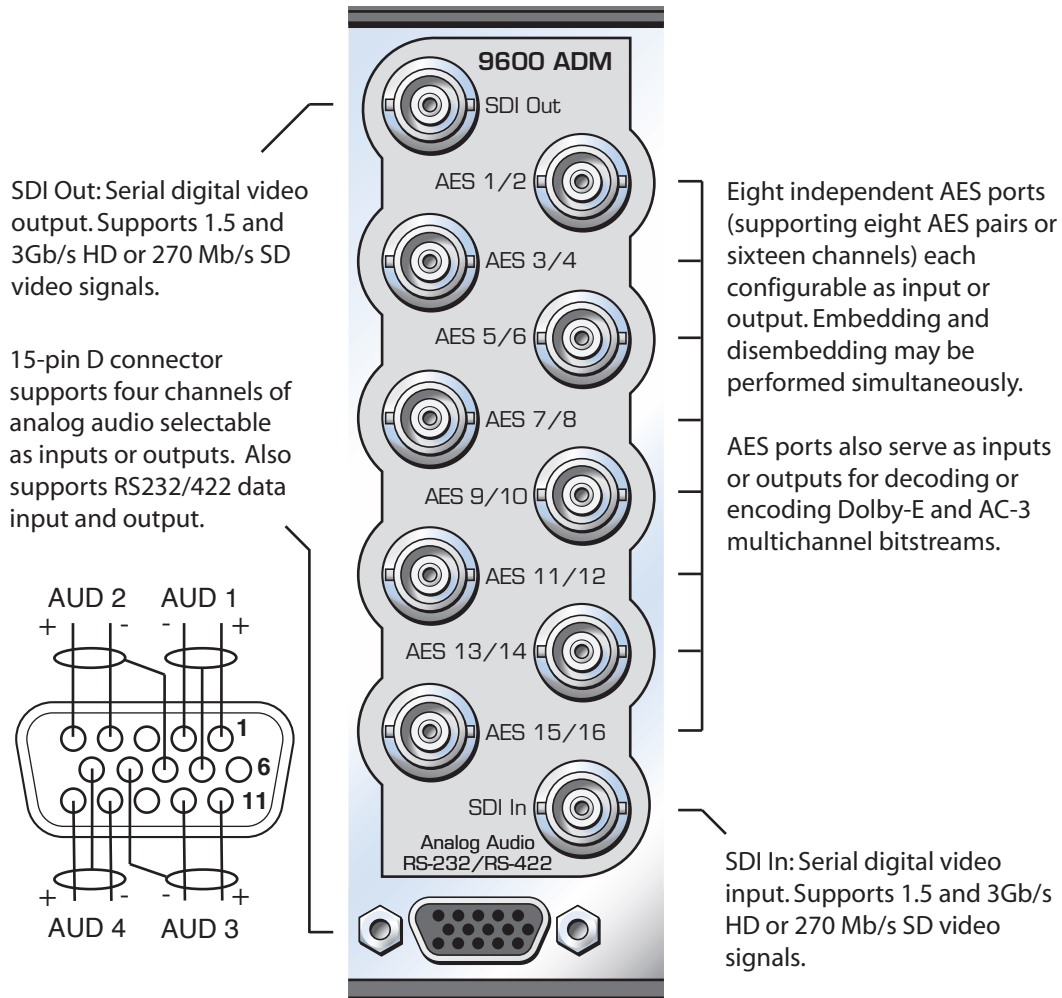

AUD 1 is on pins 1 and 2 and the associated ground is pin 7. Pin 1 is positive. AUD 2 is on pins 4 and 5 and the associated ground is pin 8. Pin 5 is positive.

AUD 3 is on pins 11 and 12 and the associated ground is pin 9. Pin 11 is positive. AUD 4 is on pins 14 and 15 and the associated ground is pin 10. Pin 15 is positive.

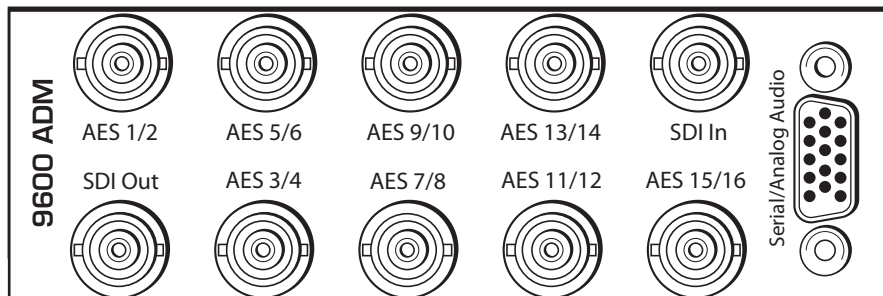

Cabling for Avenue 9600-XV

Refer to the 3RU and 1RU backplane diagrams of the module below for cabling instructions. Note that unless stated otherwise, the 1RU cabling explanations are identical to those given in the 3RU diagram.

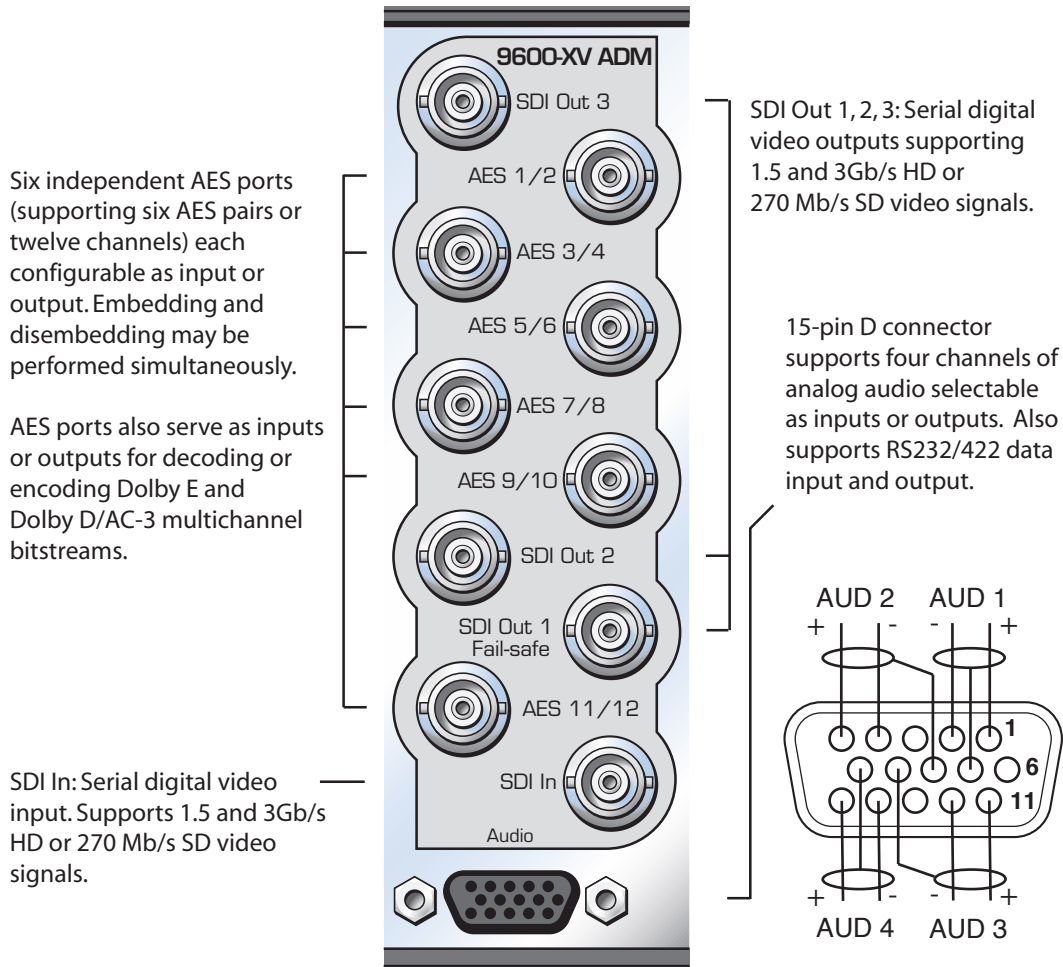

AUD 1 is on pins 1 and 2 and the associated ground is pin 7. Pin 1 is positive. AUD 2 is on pins 4 and 5 and the associated ground is pin 8. Pin 5 is positive.

AUD 3 is on pins 11 and 12 and the associated ground is pin 9. Pin 11 is positive. AUD 4 is on pins 14 and 15 and the associated ground is pin 10. Pin 15 is positive.

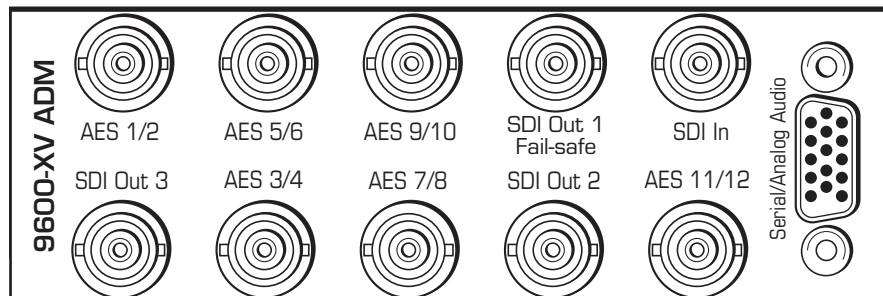

Functional Block Diagram for Avenue 9600

Shown below is the Avenue 9600 functional block diagram.

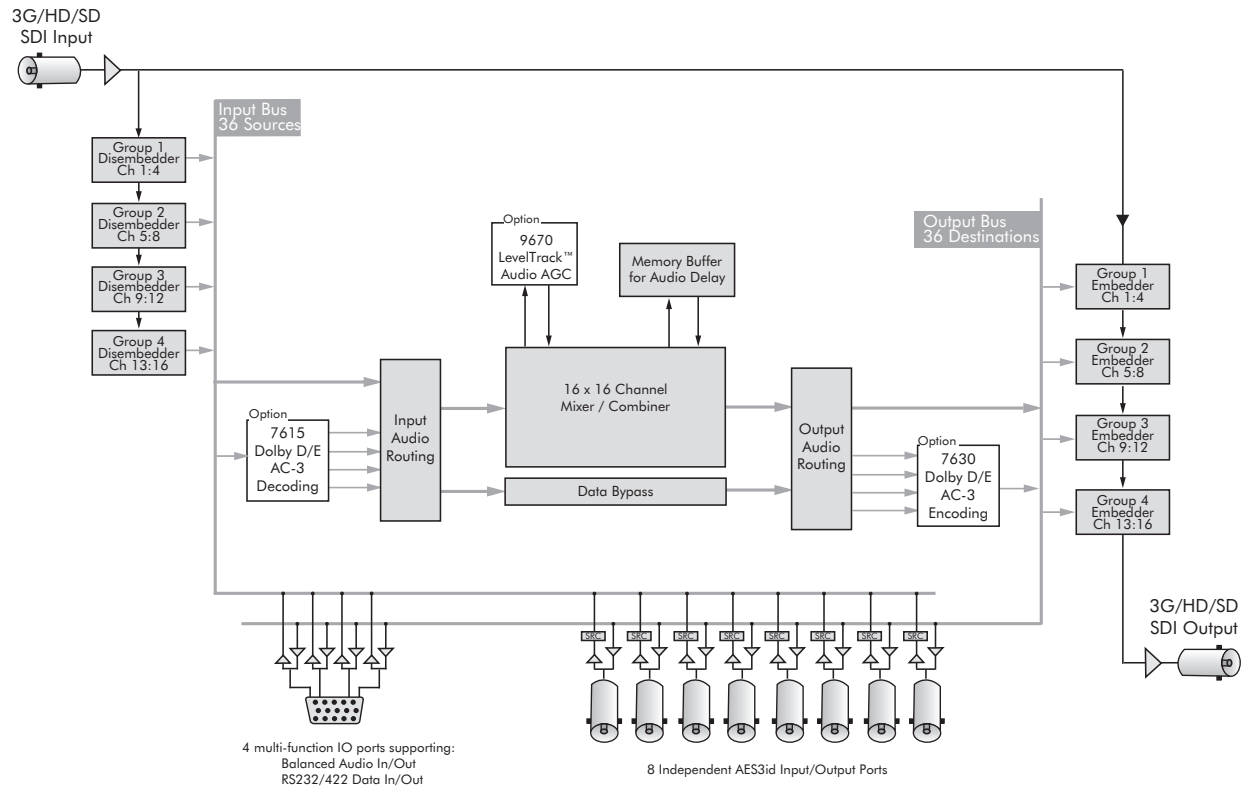

Avenue 9600 Functional Block Diagram

Functional Block Diagram for Avenue 9600-XV

Shown below is the Avenue 9600-XV functional block diagram.

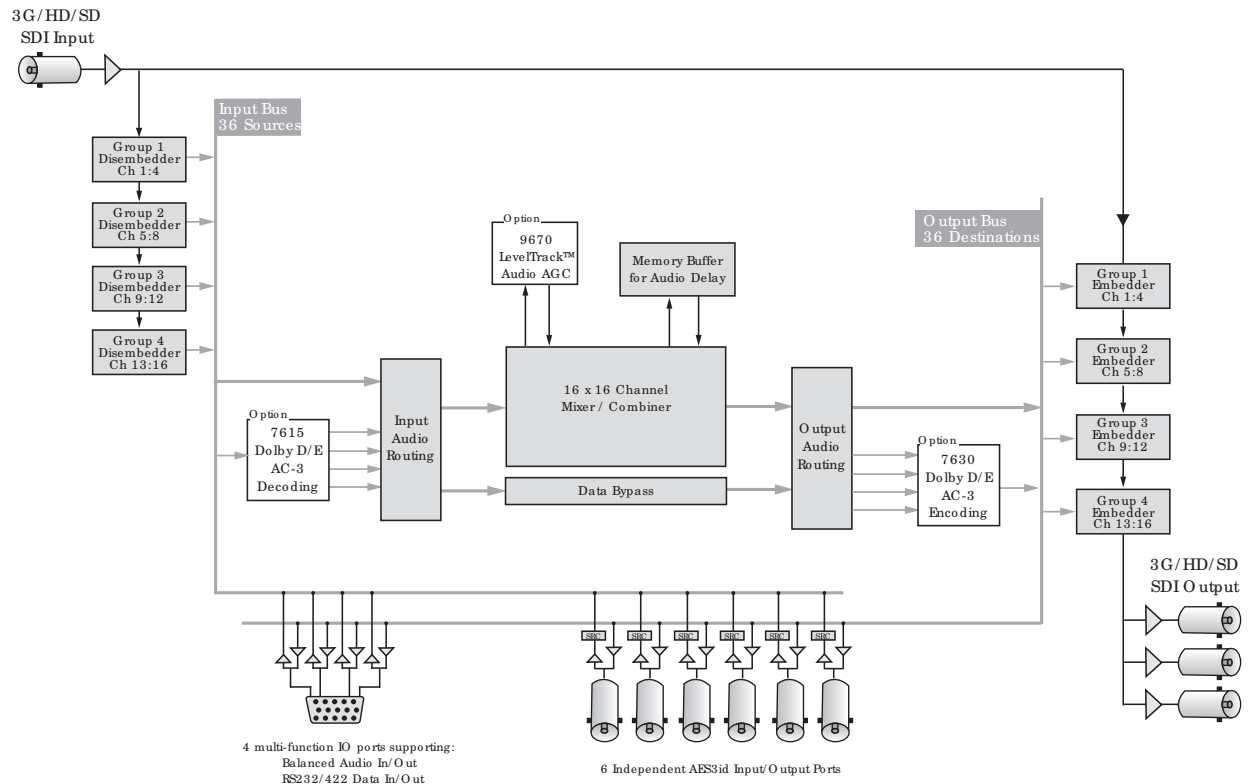

Avenue 9600-XV Functional Block Diagram

Three Use Cases

The essential functions of the 9600 are addressed in the following three use cases:

- Embedding (using the 9600 as a multiplexer)
- Disembedding (using the 9600 as a demultiplexer)
- In-line processing

Each use case is presented as a list of sequential steps. For further details about a specific process, see the corresponding menu discussion. The page number references in each use case are linked to their respective menu discussion pages. The overall menu discussion begins on [page 16](#).

After reviewing these three use cases, you will be ready to start using the 9600 module.

Embedding

These are the sequential steps to embedding:

1. Connect the video signal to the SDI In BNC input ([page 8](#)).
2. Route digital audio into the module through the AES BNC inputs; route analog audio through the 15-pin D connector ([page 8](#)).
3. Select and configure the pathways of the incoming audio signals to go to the desired mixer input channels by using the **In 1:4**, **In 5:8**, **In 9:12**, and **In 13:16** menus ([page 27](#)).
4. If you are encoding audio signals into Dolby E or Dolby D/AC-3, select which mixer channels you want to send to the encoder (up to four pairs) by using the **Encoder** menu ([page 40](#)).
5. Work with the mixer to configure gain levels, output bus assignments, Mix Mode selections, and AGC (optional) by using the **Mix 1:4**, **Mix 5:8**, **Mix 9:12**, and **Mix 13:16** menus ([page 23](#)).
6. Determine which channel groups to embed into the outgoing SDI signal by using the **Mux Out** menu ([page 21](#)).
7. If you are encoding audio signals into Dolby E or Dolby D/AC-3, use the **Encoder Insert** control on the **Mux Out** menu to place the encoder output onto a pair of audio channels on the outgoing SDI signal ([page 22](#)).

Disembedding

These are the sequential steps to disembedding:

1. Connect the video signal with embedded audio to the SDI In BNC input ([page 8](#)).
2. If you are decoding a Dolby E or Dolby D/AC-3 audio signal, indicate which pair of channels you want to decode by using the **Decoder** menu ([page 38](#)).
3. Route the decoded signal to the mixer by using the **In 1:4**, **In 5:8**, **In 9:12**, and **In 13:16** menus ([page 26](#)).
4. Route the disembedded audio to the mixer input channels by using the **In 1:4**, **In 5:8**, **In 9:12**, and **In 13:16** menus ([page 26](#)).
5. Work with the mixer to configure gain levels, Mix Mode selections, and AGC (optional) by using the **Mix 1:4**, **Mix 5:8**, **Mix 9:12**, and **Mix 13:16** menus ([page 23](#)).
6. Configure audio output using a combination of the mixer output bus assignments ([page 24](#)) for digital audio output and the **Aud Cfg** menu ([page 19](#)) for analog audio output.

In-Line Processing

These are the sequential steps to in-line processing:

1. Connect the video signal with embedded audio to the SDI In BNC input ([page 8](#)).
2. If you are decoding a Dolby E or Dolby D/AC-3 audio signal:
 - Indicate which pair of channels you want to decode by using the **Decoder** menu ([page 38](#)).
 - Route the decoded signal to the mixer by using the **In 1:4**, **In 5:8**, **In 9:12** and **In 13:16** menus ([page 29](#)).
3. Route the disembedded audio to the mixer input channels by using the **In 1:4**, **In 5:8**, **In 9:12**, and **In 13:16** menus ([page 28](#)).
4. Work with the mixer to configure gain levels, output bus assignments, Mix Mode selections, and AGC (optional) by using the **Mix 1:4**, **Mix 5:8**, **Mix 9:12**, and **Mix 13:16** menus ([page 23](#)).
5. Determine which channel groups to embed into the outgoing SDI signal using the **Mux Out** menu ([page 21](#)).
6. If you are encoding audio signals into Dolby E or Dolby D/AC-3, place the encoder output onto a pair of audio channels on the outgoing SDI signal by using the **Encoder Insert control** on the **Mux Out** menu ([page 22](#)).

Module Configuration and Control

Avenue module parameters can be configured and controlled remotely from one or both of the remote control options: the Avenue Touch Screen or the Avenue PC Application. Once the module parameters have been set remotely, the information is stored on the module CPU. This allows the module be moved to a different slot in the frame at your discretion without losing the stored information.

Avenue PC Option

For setting the parameters remotely using the Avenue PC option, refer to the Avenue PC Remote Configuration section of this document starting on [page 16](#).

Avenue Touch Screen Option

The Avenue Touch Screen option works with the same menus and controls as the Avenue PC option.

Note: At this time, the mixer menus (**Mix 1:4, Mix 5:8, Mix 9:12, Mix 13:16**) do not function with the Touch Screen interface. A pending software update will fix this issue. However, all the mixer functionality is currently available through the Avenue PC interface.

Front Panel Controls and Indicators for Avenue 9600

Each front edge indicator and switch setting is shown in the diagram below:

SDI In Video and Audio green LEDs:

One or both LEDs will light to indicate which type of signal is currently being detected. **OFF** when a signal is not detected.

AES Audio green LEDs:

For each pair of AES audio channels, the LED will light when there is a valid AES input on the corresponding BNC rear connector **and** that AES signal has been selected as an input to the mixer or to the decoder. **OFF** if a pair of AES audio channels has no input or if it is being used as an output.

Run green LED:

OFF: A power fault or halted CPU
ON: A halted CPU
FAST BLINK: CPU Run error
SLOW BLINK: System OK. (If SPI control is active from the main frame System Control Module, all **Run** indicators will be synchronized.)

Pwr green LED:

Indicates the presence (**ON**) or absence (**OFF**) of power (+5V).

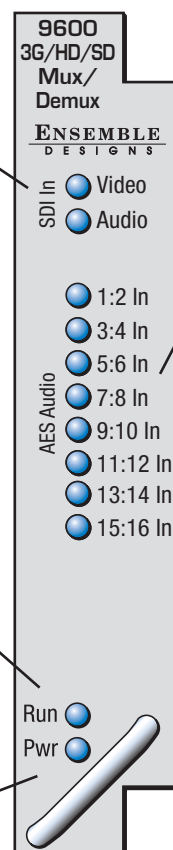

Front Panel Controls and Indicators for Avenue 9600-XV

Each front edge indicator and switch setting is shown in the diagram below:

SDI In Video and Audio green LEDs: One or both LEDs will light to indicate which type of signal is currently being detected. **OFF** when a signal is not detected.

Run green LED:
OFF: A power fault or halted CPU
ON: A halted CPU
FAST BLINK: CPU Run error
SLOW BLINK: System OK. (If SPI control is active from the main frame System Control Module, all **Run** indicators will be synchronized.)

Pwr green LED:
 Indicates the presence (**ON**) or absence (**OFF**) of power (+5V).

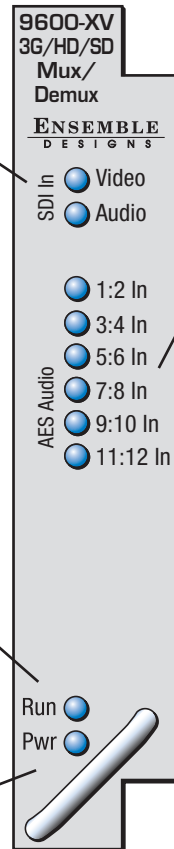

AES Audio green LEDs:
 For each pair of AES audio channels, the LED will light when there is a valid AES input on the corresponding BNC rear connector **and** that AES signal has been selected as an input to the mixer or to the decoder. **OFF** if a pair of AES audio channels has no input or if it is being used as an output.

Avenue PC Remote Configuration

The Avenue PC remote control status menu for this module is illustrated and explained below. Refer to each menu's description in the following pages for a summary of available parameters that can be set remotely through the menus illustrated. For more information on using Avenue PC, refer to the Avenue PC Control Application Software data pack that came with the option.

Parameter fields that are grayed out can indicate one of the following conditions:

- An option is not installed.
- The function is not active.
- The module is locked.
- The User Level set with Avenue PC does not permit access.

9600 Avenue PC and Avenue Touch Screen Menus

Input Menu

The 9600 module accepts these signal types:

HD Serial Digital 2.97 Gb/s
SMPTE 424M, 425M
HD Serial Digital 1.485 Gb/s
SMPTE 274M, 292M or 296M
SD Serial Digital 270 Mb/s
SMPTE 259M
Data as per SMPTE 337M

Connect the video signal with or without embedded audio to the SDI In BNC input. The **Input** menu shown on the next page indicates that there is video coming in with a video format of 1080i and a frame rate of 59.94.

Regardless of whether you are disembedding, embedding or doing in-line processing, the **Input** menu provides essential reference information regarding what is going on with the incoming video signal with respect to the groups and channels. The module detects and reports the presence or absence of embedded data and/or audio through the **Input** menu's **Grp 1 Status**, **Grp 2 Status**, **Grp 3 Status** and **Grp 4 Status** reporting fields. "D" designates data; "A" designates audio; a dash means that there is no embedded content.

For example, in the **Input** menu shown on the next page, the **Grp 1 Status** shows "1/2:D 3/4:A" indicating that channels 1 and 2 contain embedded data, and channels 3 and 4 contain embedded audio. **Grp 2 Status** and **Grp 3 Status** also show the presence of embedded audio in channels 5 through 8 and 9 through 12. **Grp 4 Status**, displaying "13/14:- 15/16:-" indicates that channels 13 through 16 do not contain embedded content.

Strip Audio Checkbox

When disembedding, you can use the **Strip Audio** checkbox to remove all embedded audio from the incoming video signal.

For embedding, the **Strip Audio** checkbox is a tool to prevent accidental group conflicts. The safest method of embedding is to first strip any embedded audio that is already present in the incoming signal by clicking the **Strip Audio** checkbox. Following that, you can re-embed the channels you want to keep.

Although it is recommended to use the **Strip Audio** checkbox, it is not strictly necessary if you are certain that you do not have any conflicting groups. For example, if only group 1 is present on the input, you could embed groups 2, 3 and 4 without first stripping group 1. However, if you embed group 1 when group 1 is already present, the result will be problematic.

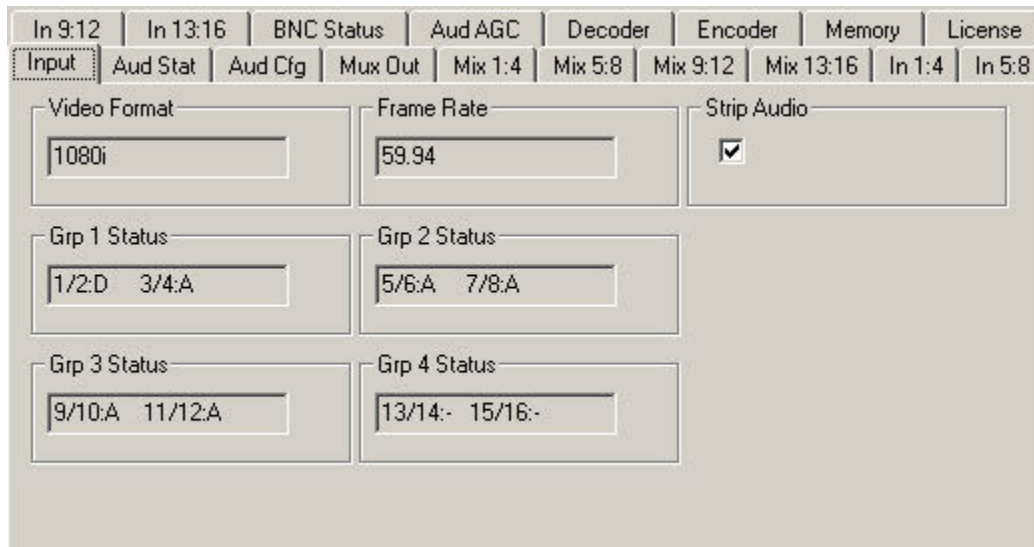

Input Avenue PC Menu showing the presence of video, embedded data and embedded audio.

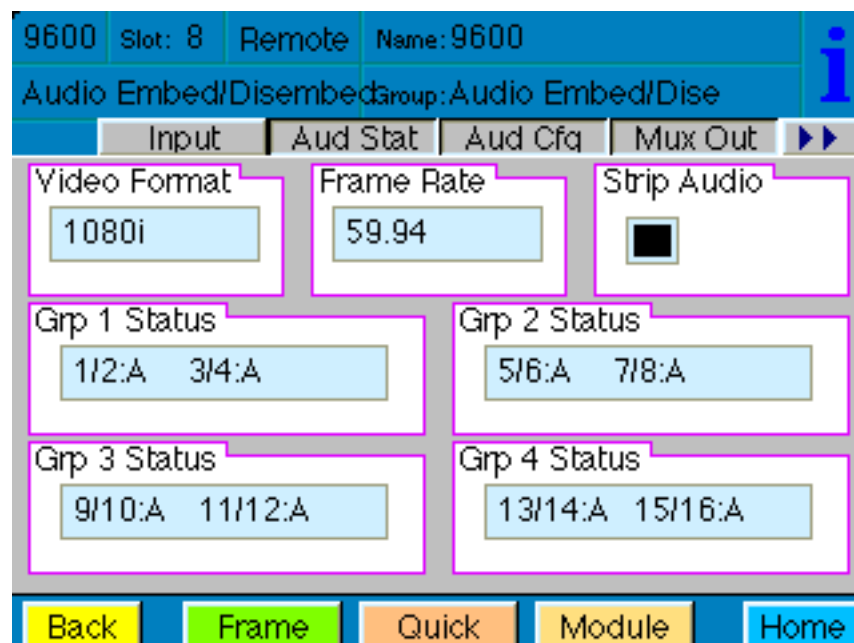

Input Avenue Touch Screen Menu showing the presence of video and embedded audio.

Aud Stat Menu

The **Aud Stat** menu reports the status of audio input for each pair of channels.

In the Avenue PC example below, channels 1/2 and 9/10 show a status of “Data Sync,” meaning that these two pairs of audio channels containing embedded data are synchronous with the video.

Channels 3/4, 5/6, 7/8, 11/12 show a status of “Audio Sync,” meaning that these four pairs of audio channels are synchronous with the video.

Channels 13/14 and 15/16 indicate that there is not any input.

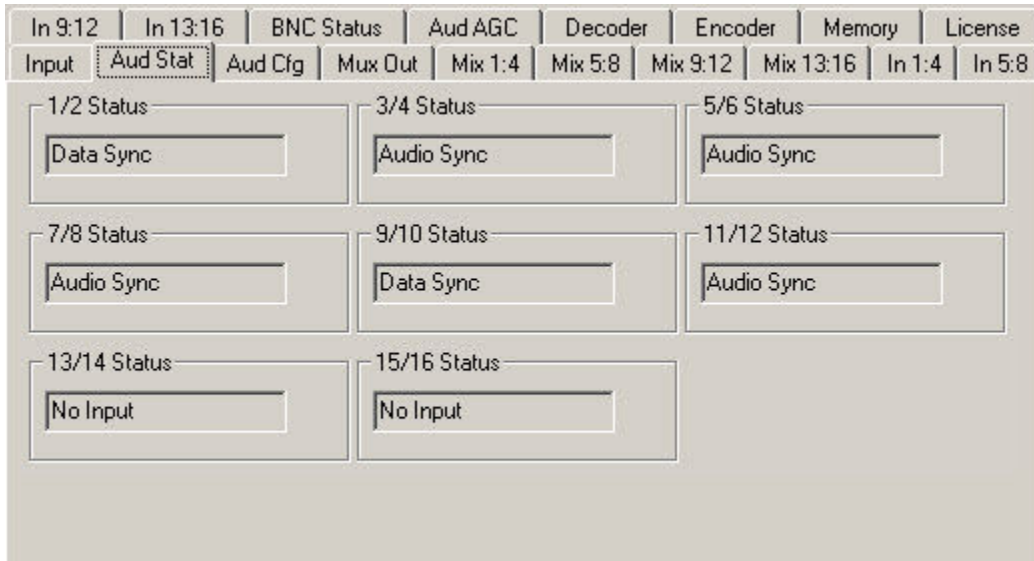

Aud Stat Avenue PC Menu

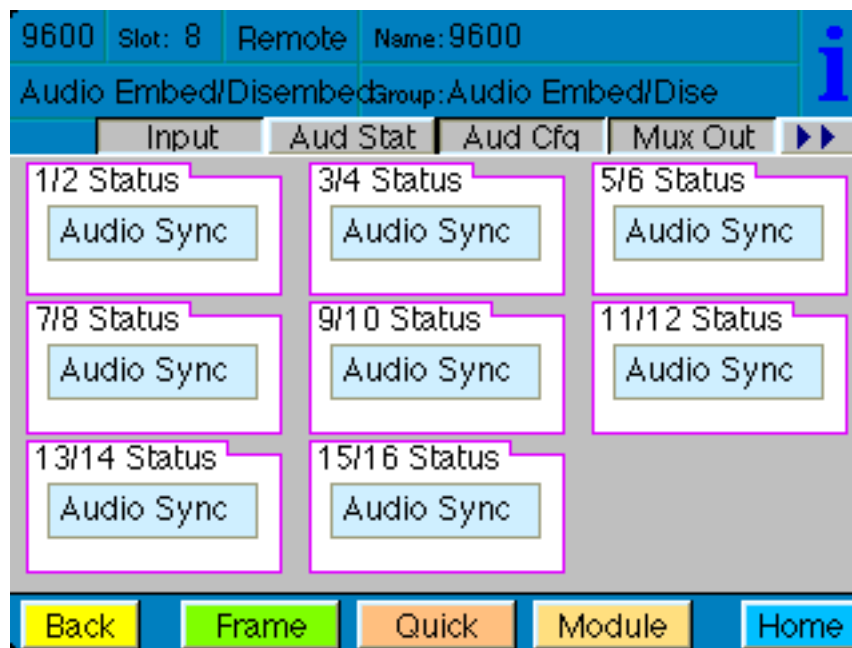

Aud Stat Avenue Touch Screen Menu

Aud Cfg Menu

Configuring Analog Audio Outputs and LevelTrack Audio Loudness Control AGC Software Option

Use the **Aud Cfg menu** to configure up to four channels of analog audio output. Analog audio goes out through the 15-pin D connector. Digital and analog audio paths may be used simultaneously.

Important! Before you can use the 15-pin D connector for analog audio, you must first install jumper connectors onto the 9600 board. See [“Configuring the Analog Audio and Balanced Digital Data Jumper Connectors”](#) on page 7 for details.

For configuring *digital* audio output, see [“Configuring Digital Audio Outputs”](#) on page 25.

From the **Anlg Out 1/2** drop-down control, select the pair of mixer channels that you want to send out through analog channels 1/2. Select the pair of mixer channels that you want to send out through analog channels 3/4 from the **Anlg Out 3/4** drop-down control.

- **Anlg Ref Level** – Set the Analog Reference Level from -10 dB to +4 dB for the analog audio output.
- **Dig Ref Level** – Digital Audio Reference Level. Applies to AES digital. -20dBFS or -18dBFS.
- **Audio Delay** – Audio Delay can be adjusted from 0 to 1000 milliseconds (mSec).

Meter Mode

Select between LKFS and dBFS. This selection determines the method by which the audio is analyzed and measured, and will impact how Audio AGC behaves.

- **LKFS** – LKFS (Loudness K-weighted relative to Full Scale) is a loudness amplitude level based on the ITU-R BS.1770 Loudness Measurement Method. It is a scale for audio measurement similar to VU or Peak, but rather than measuring gain, it measures perceived loudness. Based on a complex algorithm, this method takes into account audio processing that increases perceived loudness without increasing gain. LKFS is the measurement method required to comply with the Calm Act.
- **dBFS** – dBFS (Decibels relative to Full Scale) is a more traditional method used for measuring audio volume. For more information on decibels and dBFS, please refer to the [“Glossary”](#) on page 47.

Meter Position

The Meter Position effects both the **Final Average (yellow line)** on the AGC chart and the audio input level for the **9690 Audio Compliance and Monitoring Software**. The Meter Position is factory set to Post.

- **Pre (pre-fader)** – When Pre is selected, the **Final Average (yellow line)** on the AGC chart will not reflect any manual adjustments made in the mixer to the gain level of the channel being monitored. Similarly, the chart and recording in the **9690 Audio Compliance and Monitoring Software** will reflect the audio input level coming from your source prior to any gain or attenuation being applied in the mixer.
- **Post (post-fader)** – When Post is selected, the **Final Average (yellow line)** on the AGC chart reflects manual adjustments made in the mixer to the gain level of the channel being monitored. Similarly, the chart and recording in the **9690 Audio Compliance and Monitoring Software** reflect the audio input level coming from your source after any gain or attenuation is applied in the mixer.

LKFS Average Time

Use this control to set the amount of time used to determine the LKFS or dBFS average. 10 seconds is a typical setting.

Note: Although the control is labeled "LKFS Avg Time," if you have selected dBFS as your meter mode, the LKFS Avg time control will actually be reflecting dBFS Avg time.

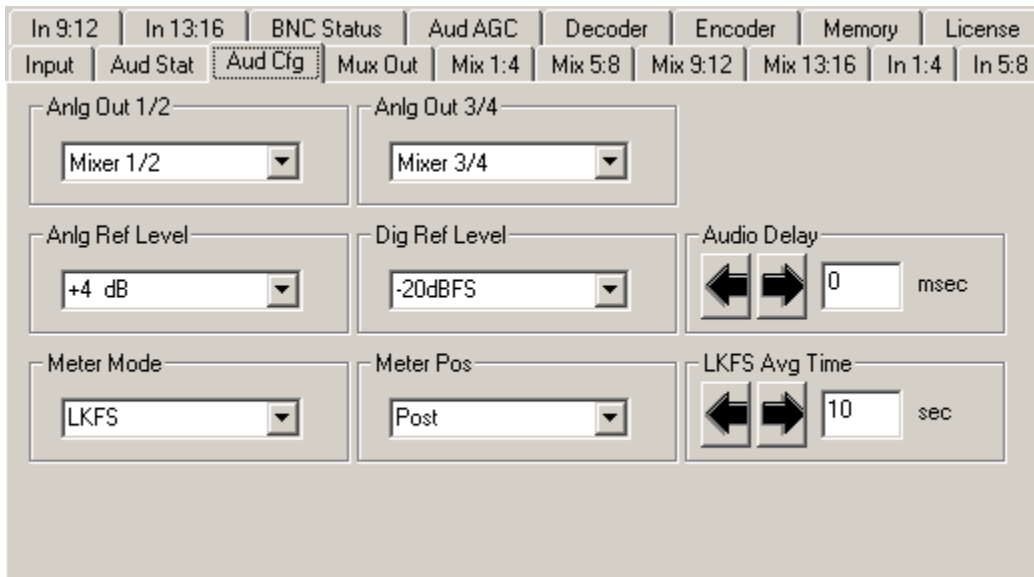

Aud Cfg Avenue PC Menu

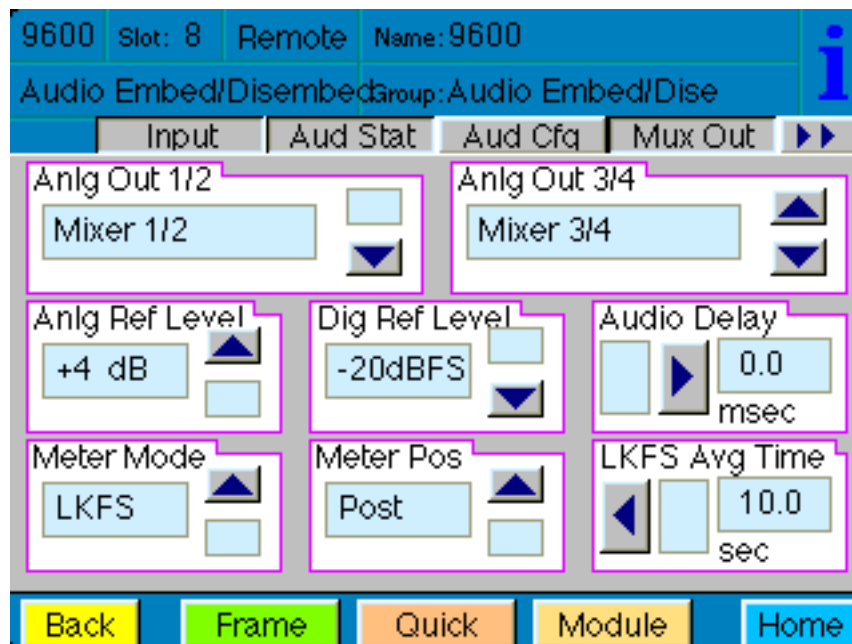

Aud Cfg Avenue Touch Screen Menu

Mux Out Menu

Determining which Audio Channels to Embed into the Outgoing SDI Signal

From the **Mux Out** menu, you can determine which mixer channels are embedded back into the outgoing SDI signal.

In the drop-down controls shown below, **Embed Grp 1** represents embedded channels 1 through 4 and is associated with mixer outputs 1 through 4. Similarly, **Embed Grp 2** represents embedded channels 5 through 8, and is associated with mixer outputs 5 through 8; **Embed Grp 3** represents embedded channels 9 through 12, fed by mixer outputs 9 through 12; **Embed Grp 4** represents embedded channels 13 through 16, fed by mixer outputs 13 through 16. Select **On** for each group of audio channels that you want to embed.

Embedded audio channels may go out of the module through as many as three paths—through the SDI signal, through the AES outputs and through the analog audio outputs.

Note: If an AES port is configured as an input, it cannot simultaneously function as an output; that would create a conflict.

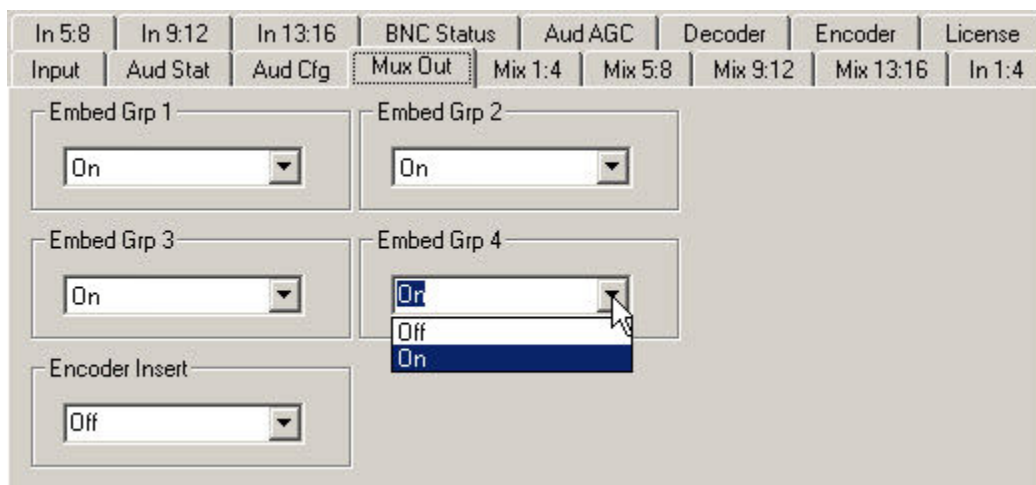

Mux Out Avenue PC Menu showing Embed Groups 1 - 4 turned on.

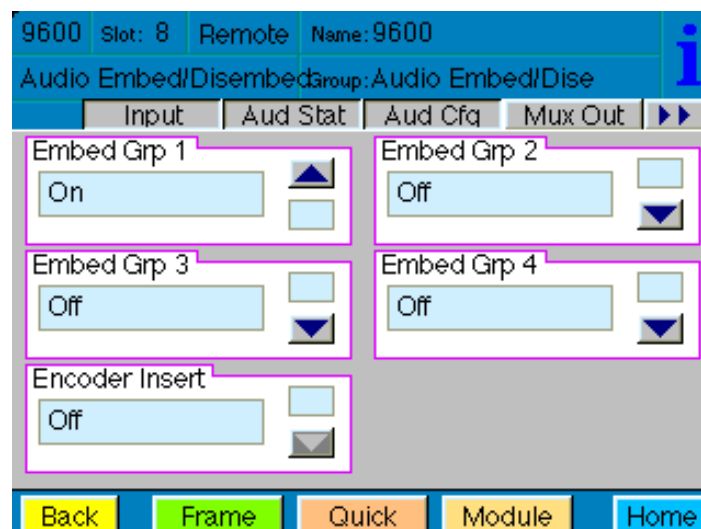

Mux Out Avenue Touch Screen Menu

Placing the Encoder Output

The Encoder output stream occupies two channels on the outgoing SDI signal. Use the **Encoder Insert** control on the **Mux Out** menu to tell the Encoder on which pair of audio channels you want to place the encoded audio for the outgoing SDI. Available selections are:

1/2, 3/4, 5/6, 7/8, 9/10, 11/12, 13/14, 15/16.

For example, the Encoder output stream will occupy channels 1/2 when 1/2 is selected from the **Encoder Insert** control. The Encoder output stream may also go out through an AES port as long as that AES port is not already being used as an input to the module.

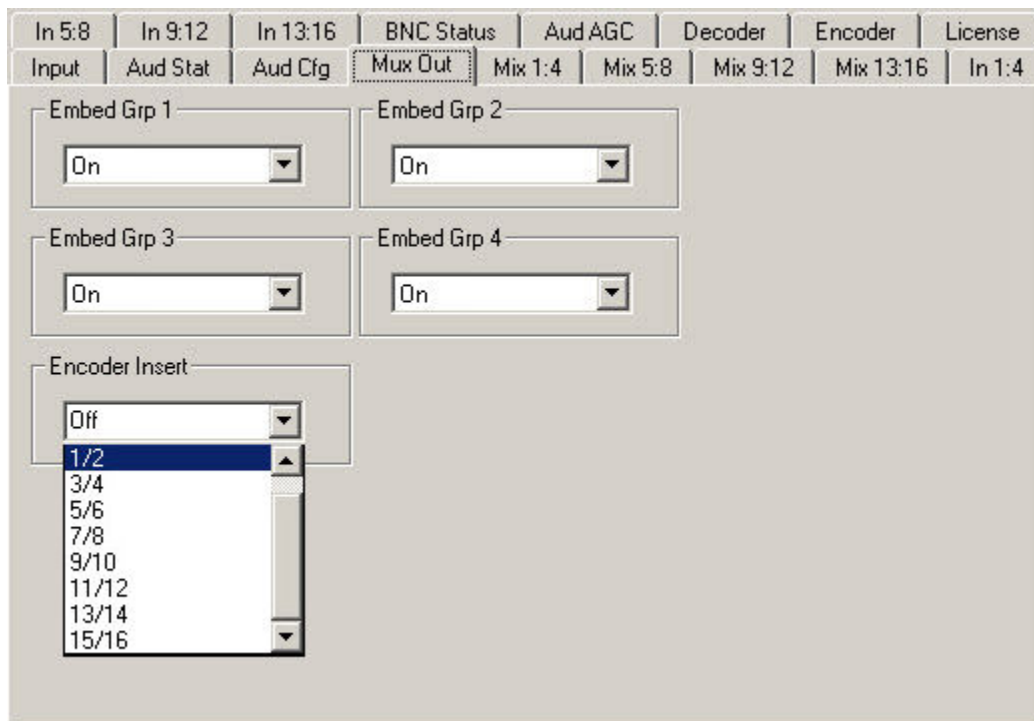

***Mux Out** Avenue PC Menu showing Embed Groups 1 - 4 turned on; also showing the selections available from the Encoder Insert drop-down control.*

Mix 1:4, Mix 5:8, Mix 9:12, Mix 13:16 Menus

Note: At this time, the mixer menus (**Mix 1:4, Mix 5:8, Mix 9:12, Mix 13:16**) do not function with the Touch Screen interface. A pending software update will fix this issue. However, all the mixer functionality is currently available through the Avenue PC interface.

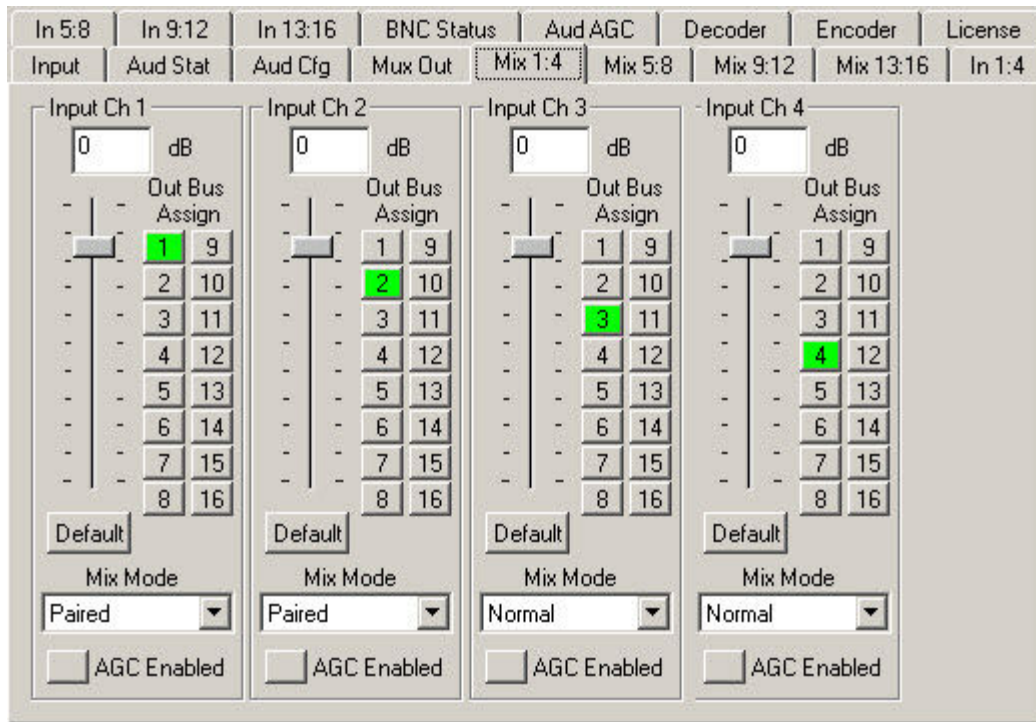

Mix 1:4 Avenue PC Menu

One common method of working with the mixer is to put the signals through unchanged, using the mixer only to indicate out bus assignments. However, you can also associate channels with one another.

Combinations of Input Channels

Any particular channel can be independent or it can be tied to other channels. When multiple channels are associated together, it affects their behavior with respect to gain control, loudness measurement, and the AGC option (automatic gain control).

The **Mix Mode** drop-down control provides the following four approaches for working with the channels:

Mix Mode	Mixer Behavior
1. Normal	Working with mixer channels independently is the default or "Normal" mix mode.
2. Paired	If you want two channels to be paired so that altering the gain of one will automatically alter the gain of the other, choose Paired from the Mix Mode drop-down control for one of the channels you want to pair; for example, channel 9 and 10 will be paired with each other if you select Paired for one of those channels.
3. Surround Sound 5.1	<p>For surround sound 5.1, which uses 6 channels, specify for each channel one of these 6 selections from the Mix Mode drop-down control.</p> <p>For example:</p> <p style="padding-left: 40px;">Input Ch 1 = Multi Left Input Ch 2 = Multi Right Input Ch 3 = Multi Center Input Ch 4 = Multi L Surr Input Ch 5 = Multi R Surr Input Ch 6 = Multi Bass</p>
4. Surround Sound 7.1	<p>For surround sound 7.1, which uses 8 channels, specify for each channel one of the above 6 selections plus two additional Mix Mode selections.</p> <p>For example:</p> <p style="padding-left: 40px;">Input Ch 7 = Multi L Rear Input Ch 8 = Multi R Rear</p>

Once you have established a pairing or surround sound grouping, changing the gain on one channel affects all of the associated channels. Also, AGC processing (if enabled) will take into account any channel pairs or surround sound groupings.

Any 8 channels may take the input from the Dolby E decoder, leaving 8 remaining input channels to assign.

Out Bus Assignments

The 9600 mixer has 16 input channels and 16 output busses. Initially, each channel is assigned a separate output bus. For example, by default, mixer input channel 1 is assigned to mixer output bus 1, indicated by the green button in the **Input Ch 1** control. However, you can assign multiple input channels to go to the same output bus. Or you can have each input channel going to multiple output busses (from 0 to 16).

Each mixer channel has a level control on its input. There is not a separate output gain level control.

Automatic Gain Control (AGC)

For any mixer channel, you can enable AGC by selecting the AGC Enabled box for a given channel. When enabled, the AGC Enabled box displays green. Note, however, that the AGC Enabled control will have no effect unless AGC is first engaged. To turn on the AGC function, select Auto from the AGC Master control in the **Aud AGC** menu ([page 34](#)).

Configuring Audio Output

From the output of the mixer, you can send digital audio out through the 8 AES connectors. Analog audio goes out through the 15-pin D connector. The digital and analog audio paths may be used simultaneously. You may also re-embed the audio.

Configuring Digital Audio Outputs

Use the **Out Bus Assign** controls from the **Mix 1:4**, **Mix 5:8**, **Mix 9:12** and **Mix 13:16** menus to route mixer inputs to mixer outputs. For digital audio, mixer output pair 1/2 feeds SDI out 1/2 and/or AES out 1/2. Mixer output pair 3/4 feeds SDI out 3/4 and/or AES out 3/4, and so on.

Note: If an AES connector is selected as an input, it cannot simultaneously be used as an output.

In 1:4, In 5:8, In 9:12, In 13:16 Menus

Use the **In 1:4**, **In 5:8**, **In 9:12**, and **In 13:16** menus to select the type of audio input (SDI, AES, Analog, or Decode) for each pair of input channels, and to direct them to a specific pair of mixer inputs. The menus **In 1:4**, **In 5:8**, **In 9:12** and **In 13:16** correspond to mixer input channels 1 through 4, 5 through 8, 9 through 12 and 13 through 16, respectively. These four menus work in the same manner.

Using the **In 1:4** menu as an example, when **SDI** is selected from the **1/2 Input** drop-down control, the following eight pairs of SDI channel selections are available in the control to its right: 1/2, 3/4, 5/6, 7/8, 9/10, 11/12, 13/14, 15/16. This reflects the 16 channels of audio that an SDI signal is capable of carrying.

When **AES** is selected from the **1/2 input** drop-down control, the Avenue 9600 has the following eight pairs of AES channel selections in the control to its right: 1/2, 3/4, 5/6, 7/8, 9/10, 11/12, 13/14, 15/16. This reflects the eight AES connectors available on the 9600. In contrast, the Avenue 9600-XV has the following six pairs of AES channel selections in the control to its right: 1/2, 3/4, 5/6, 7/8, 9/10, 11/12. This reflects the six AES connectors available on the 9600-XV. Each AES connector can carry one pair of channels.

When **Analog** is chosen, two pairs of channel choices are available: 1/2 and 3/4. This reflects the capacity of the module to carry up to four channels of analog audio through the 15-pin D connector.

When **Decode** is selected, the following four choices are available: 1/2, 3/4, 5/6 and 7/8. When decoding a Dolby D/AC-3 stream, at most 6 channels are decoded. When decoding a Dolby E stream, at most 8 channels are decoded.

Digital audio enters the module through either the SDI In connector or through the eight AES inputs. Up to two pairs or four channels of analog audio enter the module through the 15-pin D connector. A pair of wires carries one analog audio channel.

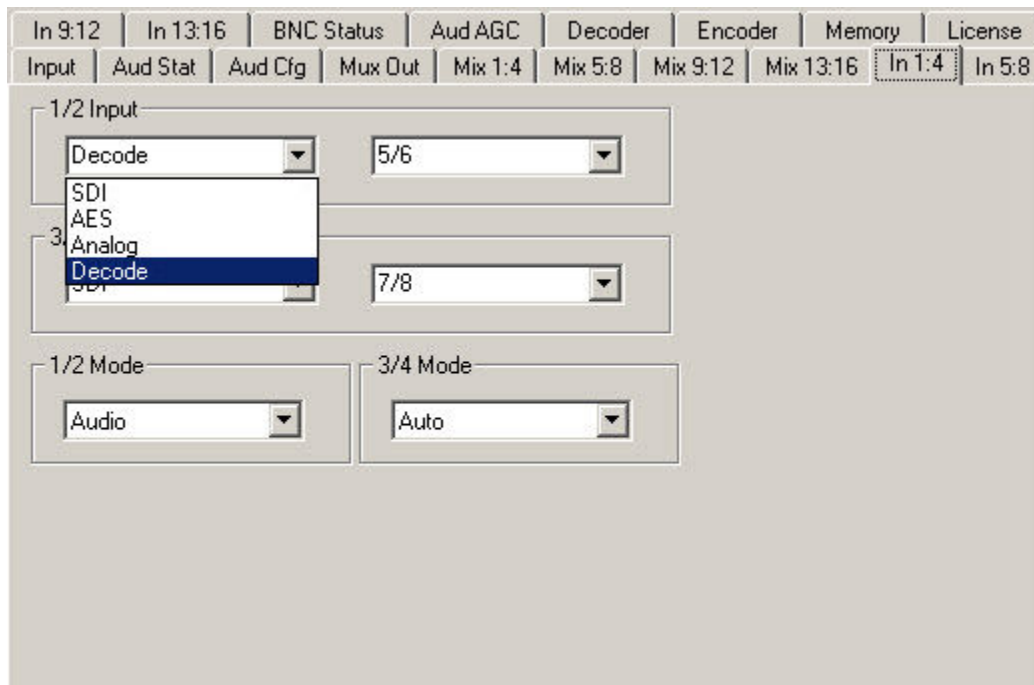

In 1:4 Avenue PC Menu

Using the In 1:4, In 5:8, In 9:12, In 13:16 Menus for Embedding

Routing the Audio into the Module

Route the audio into the module through the AES BNC inputs (for digital audio) and/or through the 15-pin D connector (for analog audio).

Important! Before you can use the 15-pin D connector for analog audio, you must first install jumper connectors onto the 9600 board. See [“Configuring the Analog Audio and Balanced Digital Data Jumper Connectors”](#) on page 7 for details.

Selecting and Configuring Incoming Audio Pathways to the Mixer

Use the **In 1:4**, **In 5:8**, **In 9:12** and **In 13:16** menus to tell the module to which mixer channels you want to direct each pair of audio channels. In this example, we are referencing the **In 1:4** menu. However, the same principles apply to the **In 5:8**, **In 9:12** and **In 13:16** menus.

For embedding, select AES or Analog for the **1/2 Input** and **3/4 Input** controls. With the corresponding drop-down controls to the right, select the pair of audio channels that you want to send to mixer input channels 1/2 and 3/4. In the example shown below, audio channels 5/6 from the incoming AES signal will go to mixer input channels 1/2. Similarly, audio channels 7/8 from the incoming AES signal will go to mixer input channels 3/4.

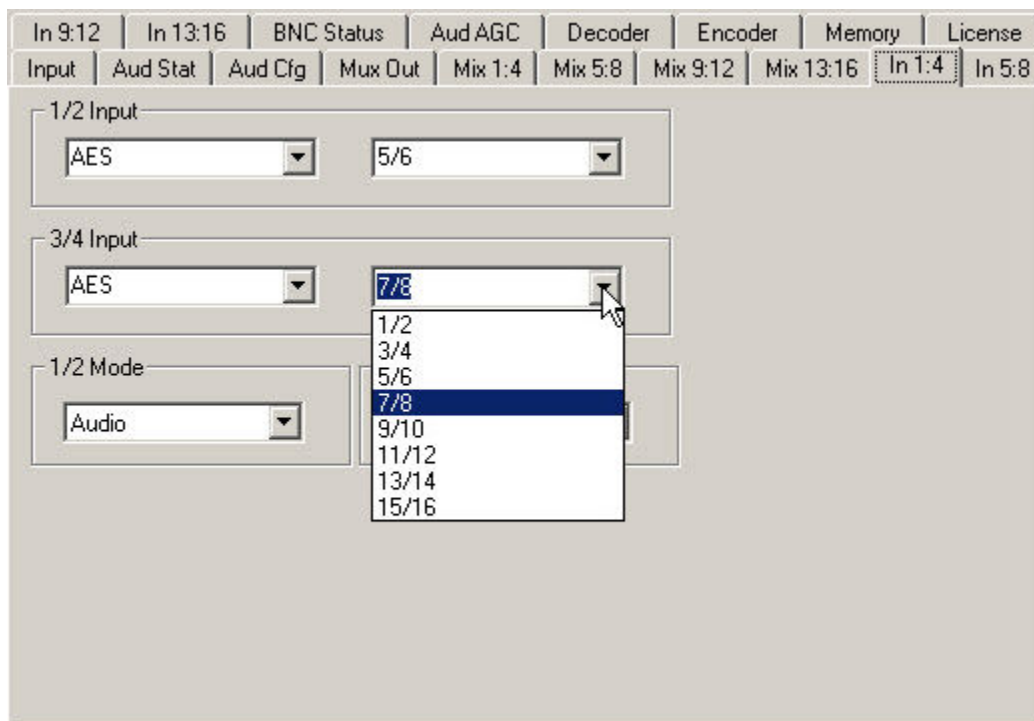

In 1:4 Avenue PC Menu showing audio being directed from AES connectors 5/6 and 7/8 to mixer input channels 1/2 and 3/4.

Using the In 1:4, In 5:8, In 9:12, In 13:16 Menus for Disembedding

Routing Disembedded Audio to Mixer Input Channels

The 9600 provides both digital and analog pathways for the audio signal. In a disembedding process, digital audio enters the module as embedded audio in the incoming SDI video signal.

For the **In 1:4** menu shown below, the pair of **1/2 Input** drop-down controls work together to control what is being sent to mixer input channels 1 and 2. The same is true for the pair of **3/4 Input** drop-down controls. The choices available in the control to the right depend on the selection you make from the control on the left. In this example, when SDI is selected from the control on the left, the choices available from the control on the right are eight pairs of channels (1/2, 3/4, 5/6, 7/8, 9/10, 11/12, 13/14, 15/16), since there are up to 16 channels of embedded audio that may be available in an incoming SDI video signal.

For disembedding, select SDI from the drop-down menus on the left side under **1/2 Input** and **3/4 Input**. With the corresponding drop-down controls to the right, specify which pair of embedded audio channels from the SDI signal that you want to send to mixer input channels 1/2 and 3/4.

For example, in the instance shown below, channels 5 and 6 of the SDI embedded audio are being directed to mixer input channels 1 and 2, while channels 7 and 8 of the SDI embedded audio are being directed to mixer input channels 3 and 4.

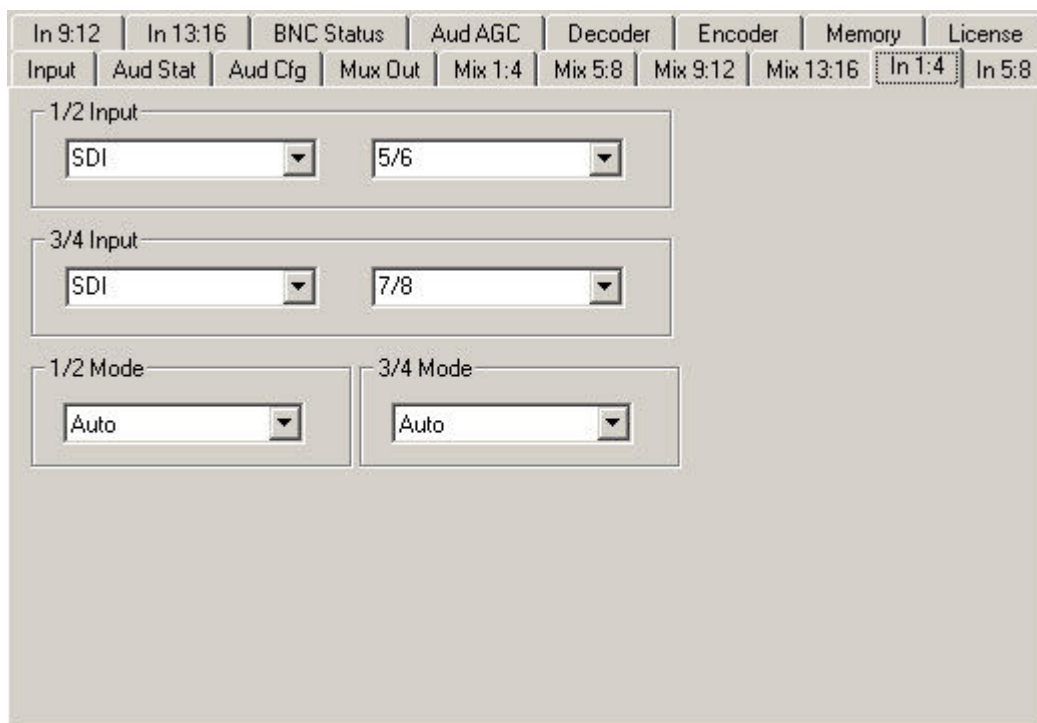

In 1:4 Avenue PC Menu showing selected SDI embedded audio channels that are being directed to mixer input channels 1/2 and 3/4.

Using the In 1:4, In 5:8, In 9:12, In 13:16 Menus for Disembedding (cont'd)

Routing the Decoded Signal to the Mixer (Applicable Only when Decoding)

To route the output path for the decoded signal, or, to put it another way, to choose the output channels of the decoder as inputs to the mixer, make a selection from one or more of the menus **In 1:4**, **In 5:8**, **In 9:12**, and **In 13:16**.

To send a decoded signal to mixer channels 1/2:

1. Navigate to the **In 1:4 menu**. From this menu, you can determine what is being sent to mixer channels 1 through 4.

Use the **1/2 Input control** to configure what is being sent to mixer input channels 1/2. Note that the **1/2 Input control** consists of a pair of drop-down menus that together determine what is being sent to mixer input channels 1 and 2. The **3/4 Input control** works in the same manner.

2. From the **1/2 Input control**, select Decode from the left drop-down menu.
3. From the corresponding right drop-down menu, select the pair of channels from the decoder that you want to send to mixer input channels 1/2.

In the example shown below, channels 5/6 from the decoder are being sent to mixer input channels 1/2. Additionally, channels 7/8 from the SDI signal are being sent to mixer input channels 3/4.

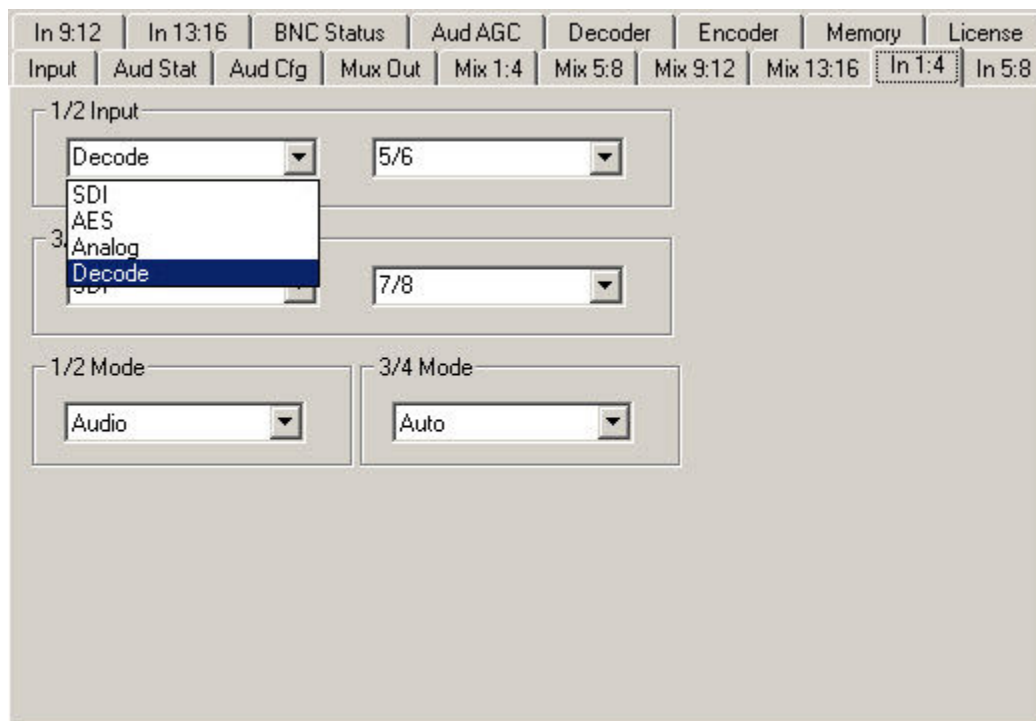

In 1:4 Avenue PC Menu showing channels 5/6 from the decoded signal going to mixer input channels 1/2, while channels 7/8 from the SDI signal are going to mixer input channels 3/4.

Using the In 1:4, In 5:8, In 9:12, In 13:16 Menus for In-line Processing

Because the 9600 can perform simultaneous disembedding and embedding, it is an in-line processor for embedded audio. It can take embedded content, adjust levels and remap channels, and deliver it to the output as an embedded signal.

Routing Disembedded Audio to Mixer Input Channels

The 9600 provides both digital and analog pathways for the audio signal. In a disembedding process, digital audio enters the module as embedded audio in the incoming SDI video signal.

In 1:4, In 5:8, In 9:12, In 13:16 Menus

For disembedding, select SDI from the drop-down menus on the left side under **1/2 Input** and **3/4 Input**. With the corresponding drop-down controls to the right, specify which pair of embedded audio channels from the SDI signal that you want to send to mixer input channels 1/2 and 3/4.

For example, in the instance shown below, channels 5 and 6 of the SDI embedded audio are being directed to mixer input channels 1 and 2, while channels 7 and 8 of the SDI embedded audio are being directed to mixer input channels 3 and 4.

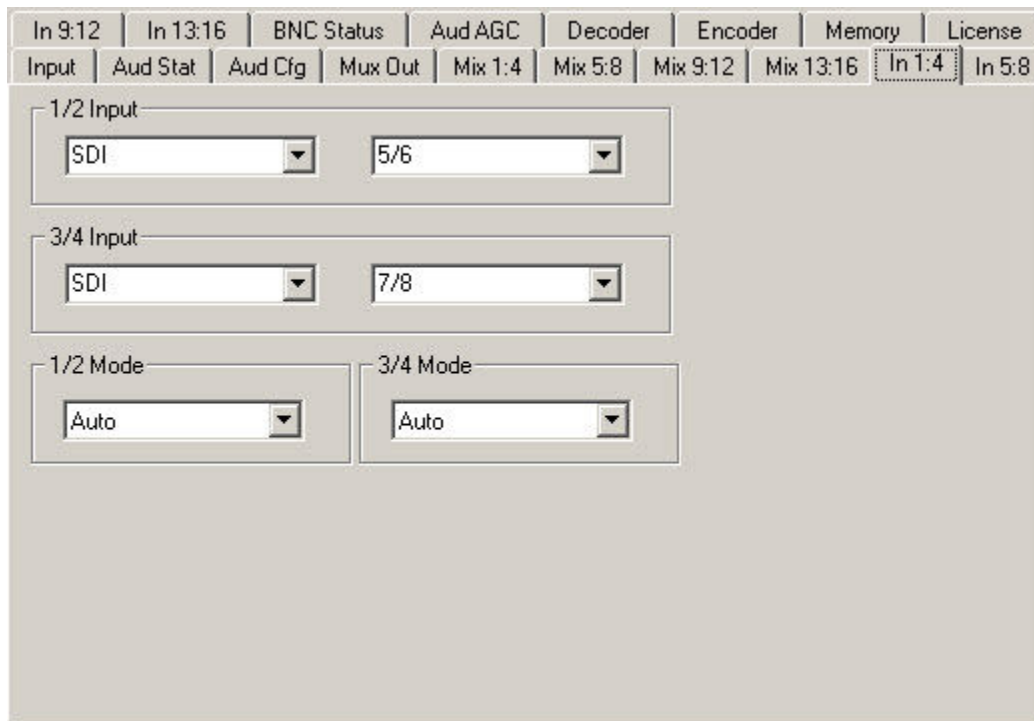

In 1:4 Avenue PC Menu showing selected SDI embedded audio channels that are being directed to mixer input channels 1/2 and 3/4.

Using the In 1:4, In 5:8, In 9:12, In 13:16 Menus for In-line Processing (cont'd)

Routing the Decoded Signal to the Mixer (Applicable Only when Decoding)

To route the output path for the decoded signal, or, to put it another way, to choose the output channels of the decoder as inputs to the mixer, make a selection from one or more of the menus **In 1:4**, **In 5:8**, **In 9:12**, and **In 13:16**.

To send a decoded signal to mixer channels 1/2:

1. From the **1/2 Input control**, select Decode from the left drop-down menu.
2. From the corresponding right drop-down menu, select the pair of channels from the decoder that you want to send to mixer input channels 1/2.

In the example shown below, channels 5/6 from the decoder are being sent to mixer input channels 1/2. Additionally, channels 7/8 from the SDI signal are being sent to mixer input channels 3/4.

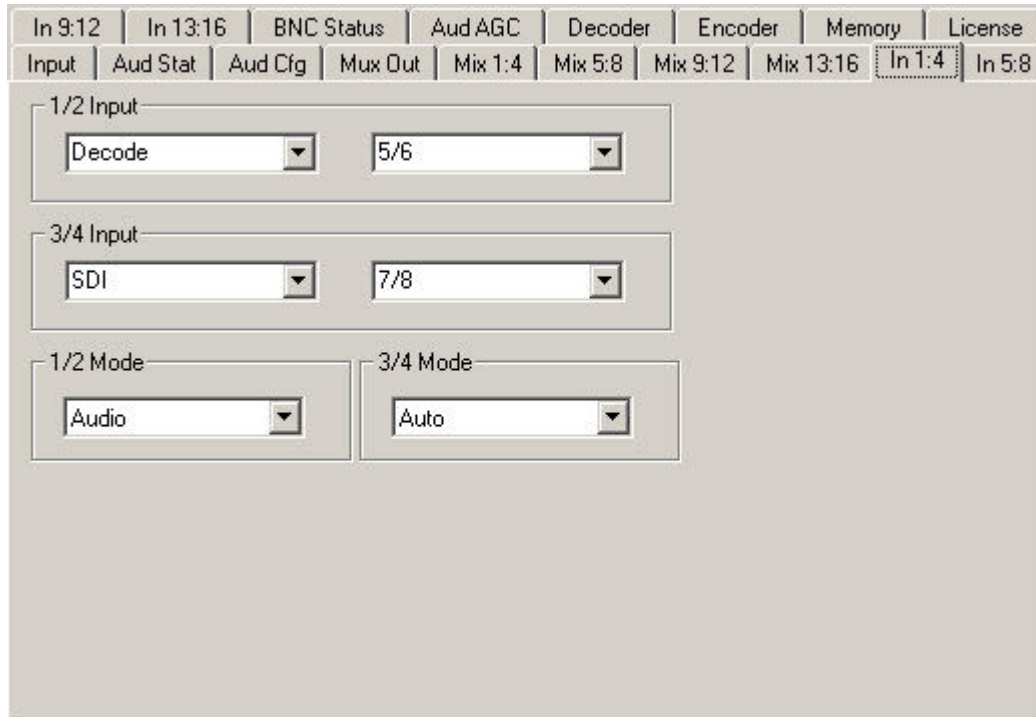

In 1:4 Avenue PC Menu showing channels 5/6 from the decoded signal going to mixer input channels 1/2, while channels 7/8 from the SDI signal are going to mixer input channels 3/4.

Audio Mode, Data Mode, Auto Mode

Another important configuration setting from the **In 1:4**, **In 5:8**, **In 9:12** and **In 13:16 menus** is setting the type of audio functionality according to your intended use for each pair of mixer input channels. Use the **1/2 Mode** and **3/4 Mode** drop-down controls (and their equivalents on the **In 5:8 menu**, **In 9:12 menu**, and **13:16 menu**) to select one of these modes: Audio Mode, Data Mode, or Auto Mode.

Audio Mode	Select Audio Mode when you are using the AES-3 standard (audio encoded as PCM data), the common digital audio format that carries two channels in one stream.
Data Mode	Select Data Mode when you want to bypass the mixer to avoid the possibility of unintentionally changing the data. This is appropriate when using Dolby-encoded data, because Dolby sets the bit to Audio. Therefore, you will need to tag Dolby streams as Data so that they do not become damaged in the mixer. Data Mode is also appropriate for non-audio PCM data packaged into AES audio format according to the SMPTE-337 specification.
Auto Mode	There is a bit in the AES packet that identifies it as Audio or Data when the packet is generated. If that bit is set correctly, Auto Mode will detect whether the packet is Audio or Data.

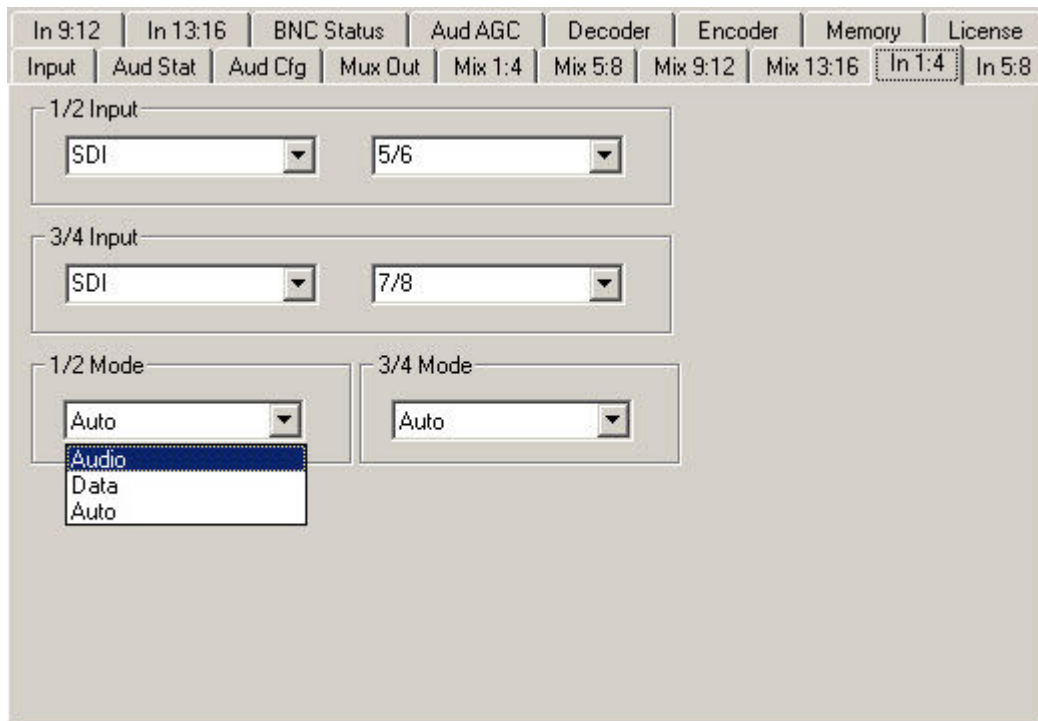

Aud Mode Avenue PC Menu

BNC Status Menu

Verifying BNC Status

The **BNC Status** menu reports the directionality of the eight AES BNC ports for the 9600 (or six AES BNC ports for the 9600-XV). In the Avenue PC example shown below of a 9600, all of them are outputs except for AES 5/6 BNC and AES 7/8 BNC, which are functioning as inputs.

Each AES connector carries one stream of audio (two channels). In the case of a Dolby E or Dolby D/AC-3 encoded stream, the stream may carry 6 to 8 channels.

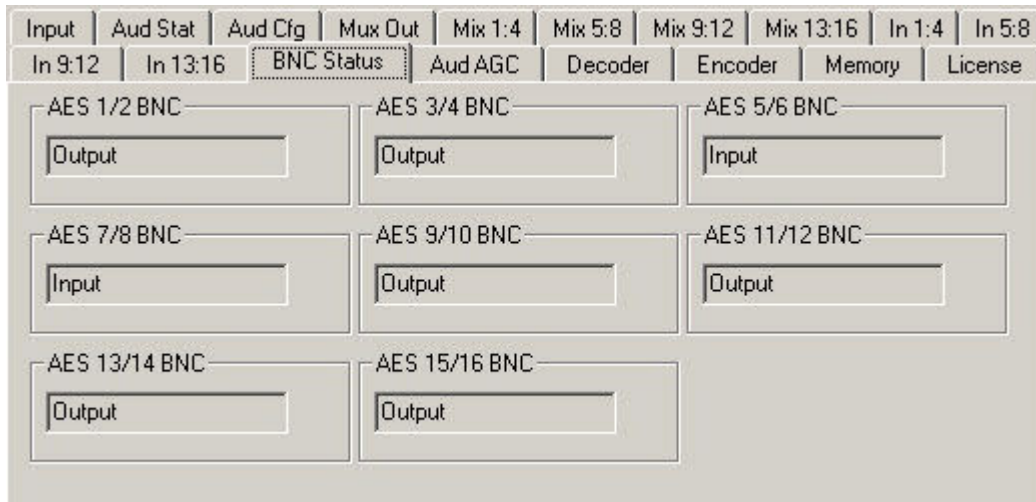

BNC Status Avenue PC Menu showing that AES BNCs 1/2, 3/4, 9/10, 11/12, 13/14 and 15/16 are functioning as outputs, while AES BNCs 5/6 and 7/8 are functioning as inputs.

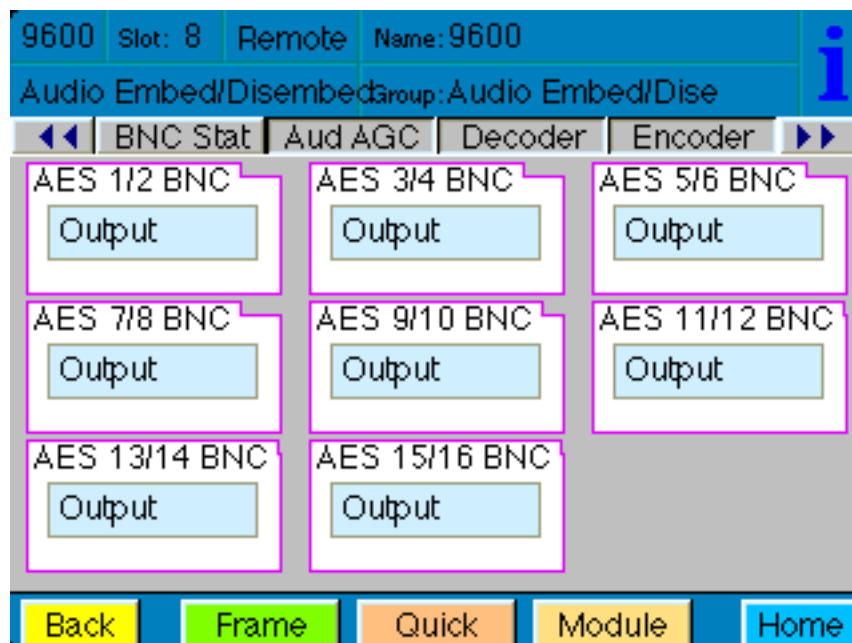

BNC Status Avenue Touch Screen Menu

Aud AGC Menu

The LevelTrack Audio Loudness Control AGC option adds an operator configurable audio level management system to Avenue signal processing modules. LevelTrack will correct mismatched audio levels between different program sources or segments within a program. Errors of this type are regrettably common due to inconsistencies between different providers and program elements.

LevelTrack will automatically monitor the levels in up to 16 audio channels. Based upon the history in each channel, LevelTrack applies gradual changes to prevent the audio level from dropping below or exceeding user-programmable thresholds. The operator can apply this automatic level control to an individual channel, a stereo pair, or surround channels. By adjusting the overall level of the signal rather than masking the errors with compression, LevelTrack will not upset the internal dynamics of the program material.

LevelTrack Configuration

Operators can perform all of the configuration for LevelTrack Audio Loudness Control AGC from the Aud AGC menu. The following is a detailed description of the LevelTrack Audio Loudness Control AGC controls and how they are used:

AGC Master

- **Off** – When set to Off the LevelTrack Loudness Control AGC functions are turned off. At the moment that LevelTrack Loudness Control is switched off it will smoothly reduce the gain or attenuation (if any) that it had been applying.
- **On** – When set to On, the LevelTrack Loudness Control system engages. It will use the measured dBFS or LKFS of the incoming signal to determine how much gain or attenuation should be applied.

Final Gain

This status indicator shows how much correction, either gain or attenuation, the LevelTrack Loudness Control system is applying.

Silence Limit

0 to -70, factory set to -40 LKFS.

Use this control to establish the value for what is considered to be silence. For example, when set to the value of -40 LKFS, levels that are at and below that value are treated as silence.

Target Level

0 to -50, factory set to -24 LKFS.

The Target Level setting establishes the target output audio level. The LevelTrack Loudness Control AGC function will automatically apply gain or attenuation to the signal to bring it within the range defined by the Target Level and the Spread.

Note: LKFS is interpreted as the inverse of Dialnorm. For example, if your goal is to output Dialnorm 24, set your Target Level at -24.

Spread

0 to 50, factory set to 1 LKFS.

Set the Spread from x to x. The Spread indicates how far above and below the Target Level you want to allow the AGC to go. A typical setting is 1. If, for example, the Target Level is set at -24 LKFS, and the Spread is set at 1, the AGC will aim to keep the output signal between -25 and -23 LKFS.

Transition Time

0.5 sec to 30 sec, factory set to 3 seconds.

This setting controls how rapidly LevelTrack Loudness Control will make adjustments once it determines that a change is needed.

Max Atten

0 dB to -12 dB, factory set to -12 bB.

This control sets the maximum amount of attenuation that LevelTrack Loudness Control can use to reduce audio levels.

Max Gain

0 dB to +12 dB, factory set to 12 bB.

This control sets the maximum amount of gain that LevelTrack Loudness Control can apply to the input in order to raise audio levels.

Taken as a whole, these controls provide tremendous flexibility in both how LevelTrack Loudness Control AGC is configured and in how audio is perceived by the listener.

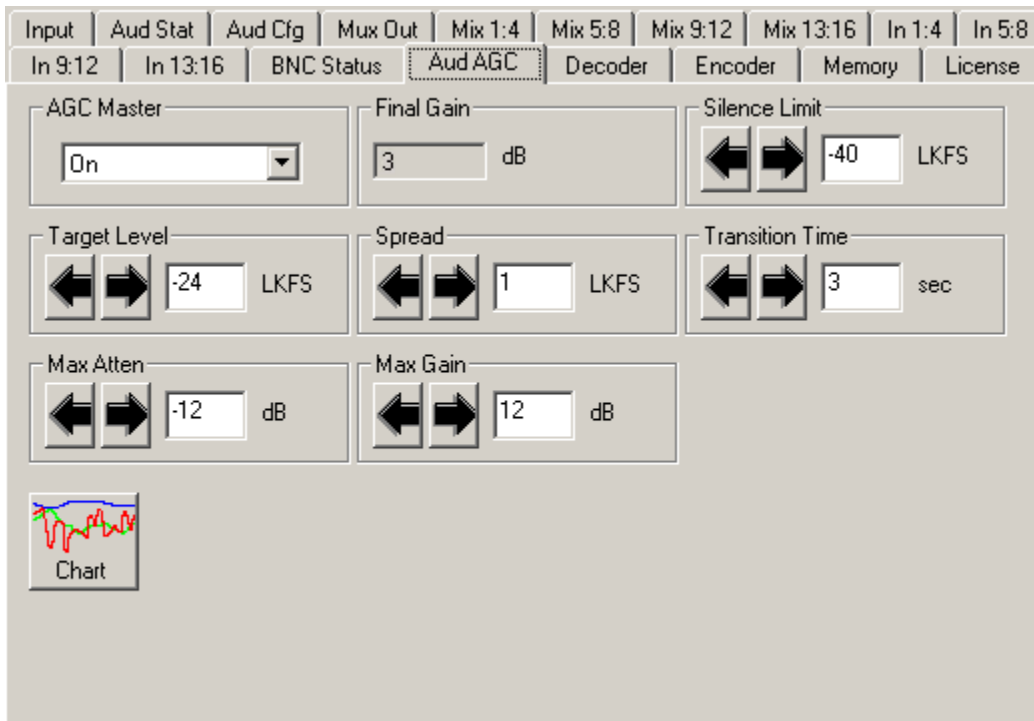

Aud AGC Avenue PC Menu

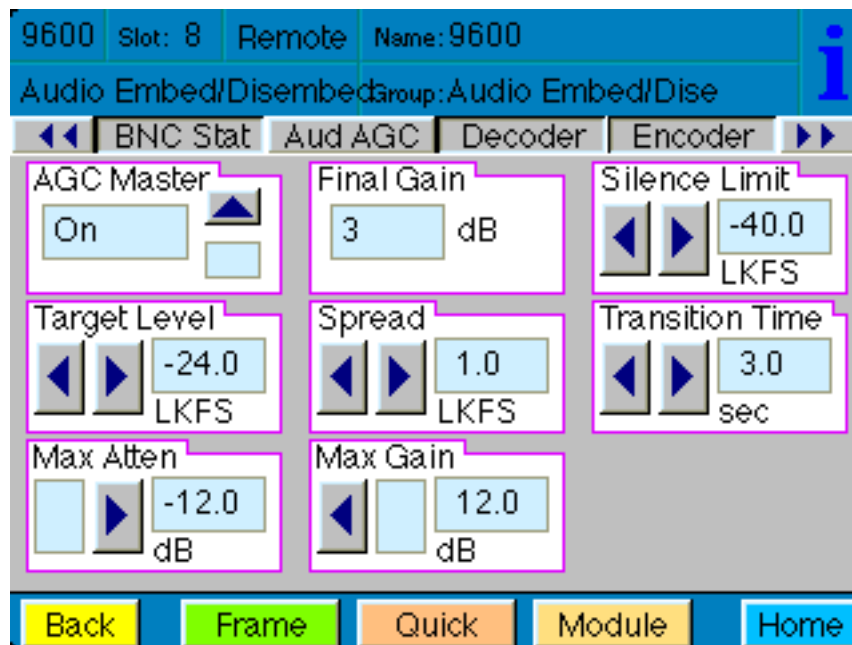

Aud AGC Avenue Touch Screen Menu

Chart

Click the **Chart button** to view a visual representation of AGC behavior on a channel-by-channel basis. The chart represents the most recent two-minute span of time for analysis performed on the channel selected in the **CH Sel** drop-down menu.

- **In Audio Level (red line):** The red line represents the level of the audio signal as it enters the Avenue module, prior to being processed by AGC.
- **Average Level (green line):** The green line represents an averaging of the incoming audio signal level.
- **Final Gain (blue line):** The blue line represents the Final Gain expressed in terms of decibels (dB). This shows how much the AGC is adjusting the level of the audio signal based on the configuration parameters specified in the **Aud AGC** menu.
- **Final Average (yellow line):** The yellow line represents the final corrected output, calculated from the Average Level and the Final Gain. The yellow line reflects manual adjustments made to the gain level on the mixer for the channel being charted, provided that the **Meter Position** is set to **Post** on the **Aud Cfg** menu.
- **CH Sel** drop-down menu: LevelTrack Loudness Control automatically monitors the levels in up to 16 audio channels. From the drop-down menu, select the channel for which you want to view the LevelTrack Loudness Control AGC behavior.

Note: The Chart's graph lines remain active as long as you are looking at the corresponding module on Avenue PC. However, if you keep the chart window open, and then select a different Avenue module through Avenue PC, the chart's graph lines will go flat. AGC is still active, however, until it is turned off in the **AGC Master** drop-down menu.

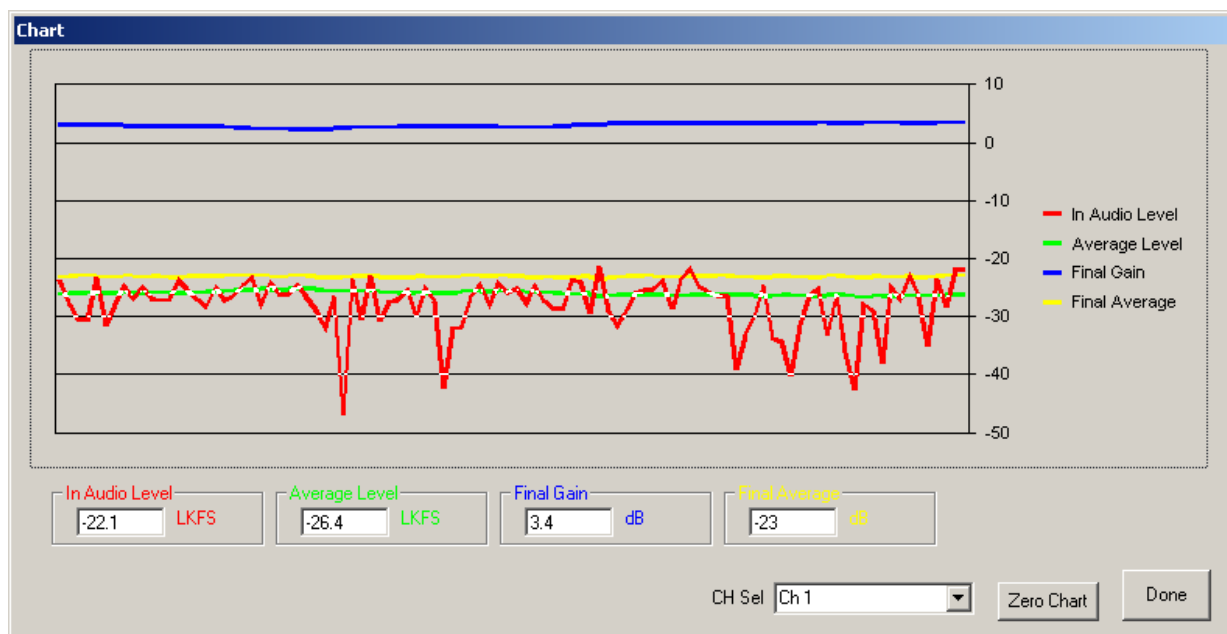

Aud AGC Chart

Decoder Menu

Decoding Dolby E or Dolby D/AC-3

If you have purchased the 7615 Dolby E or Dolby D/AC-3 decoder sub module and software key option, you can decode one encoded stream. Signals going into the decoder are compressed.

Specifying the Input Signal to be Decoded

To specify the input signal to be decoded, make a selection from the **Input Sel** drop-down control on the **Decoder** menu. For the Avenue 9600, you can choose a pair of SDI or AES channels for input from one of the following sixteen selections:

SDI 1/2, SDI 3/4, SDI 5/6, SDI 7/8, SDI 9/10, SDI 11/12, SDI 13/14, SDI 15/16
AES 1/2, AES 3/4, AES 5/6, AES 7/8, AES 9/10, AES 11/12, AES 13/14, AES 15/16.

Note: For the Avenue 9600-XV, AES 13/14 and AES 15/16 are not present. Instead, those BNC connectors are used for SDI Outputs.

Input Format is a reporting field showing what the decoder is receiving. In the example shown below, the Input Format is "Dolby E." Other possible values for this field are AC-3, PCM, No Input, and Unknwn.

When decoding a Dolby D/AC-3 stream, at most 6 channels are decoded. When decoding a Dolby E stream, at most 8 channels are decoded.

Meta Data Dest: Use this control to select Serial 1, Serial 2, Serial 3, or Serial 4 as the destination of the meta data coming from the signal being decoded. The serial ports go through the 15-pin D connector. Note that you must first configure the jumper connectors to work with data before you can use the serial ports in this manner. See "Configuring the Analog Audio and Balanced Digital Data Jumper Connectors" on page 7 for details.

Dialnorm Value: This is a value that comes from the metadata in a decoded signal. It is determined by the content provider.

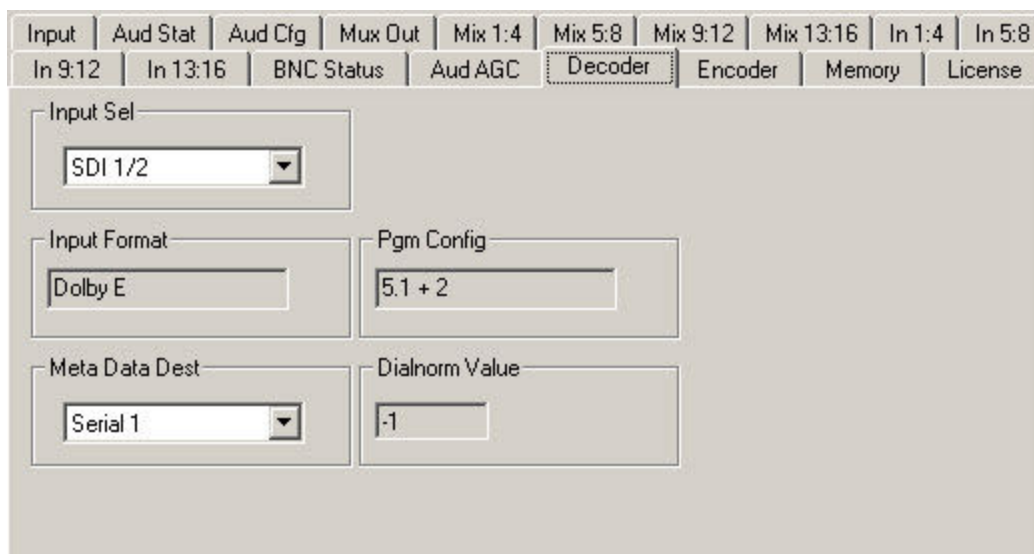

Decoder Avenue PC Menu showing that channels 1 and 2 of the incoming SDI signal are being sent to the Decoder.

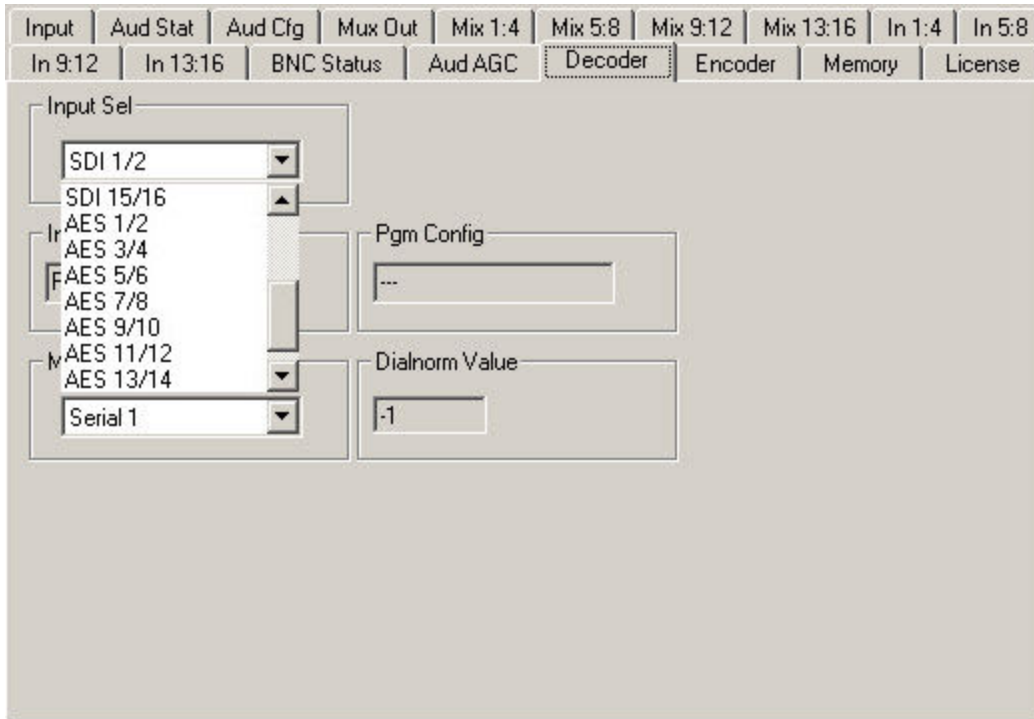

Decoder Avenue PC Menu showing the **Input Sel** drop-down control available selections

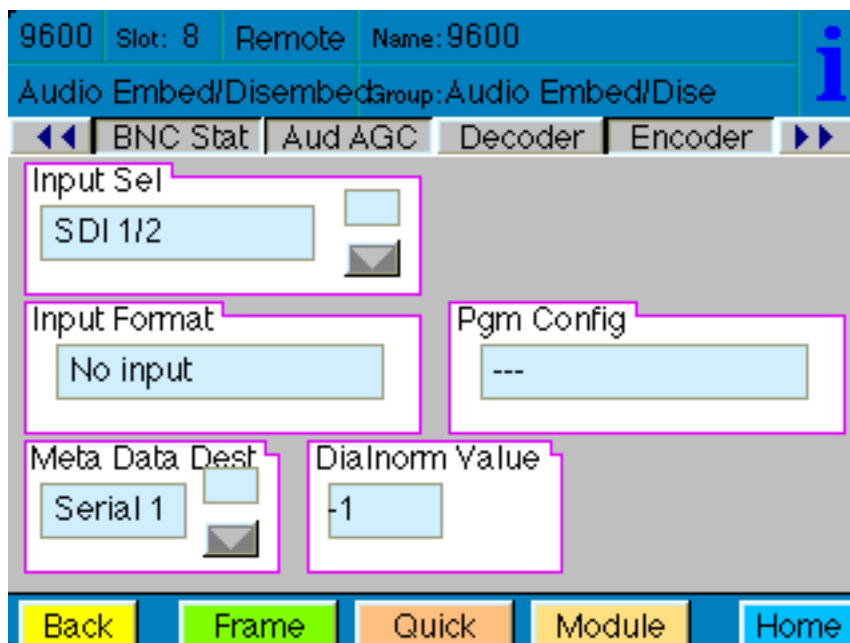

Decoder Avenue Touch Screen Menu

Encoder Menu

Encoding Dolby E or Dolby D/AC-3

If you have purchased the 7630 Dolby E or 7635 Dolby D/AC-3 encoder sub module and software key option, you can encode up to four pairs, or one stream. Select which mixer channels you want to send to the encoder by using the **Encoder** menu. Signals going out of the encoder are compressed.

Specifying the Mixer Channels to be Encoded

To specify the mixer channels to be encoded, make a selection from one or more of the **Encoder In Sel** drop-down controls on the **Encoder** menu. From each control, you can choose from the following pairs of mixer channels:

Mixer 1/2, Mixer 3/4, Mixer 5/6, Mixer 7/8, Mixer 9/10, Mixer 11/12, Mixer 13/14, Mixer 15/16

When encoding a Dolby D/AC-3 stream, at most 6 channels are encoded. When encoding a Dolby E stream, at most 8 channels are encoded.

The **Encoder Type** field reports which type of encoder is installed.

Meta Data Src: Use this control to select Serial 1, Serial 2, Serial 3, Serial 4 or Decoder as the source of the meta data going into the signal being encoded. The serial ports go through the 15-pin D connector. Note that you must first configure the jumper connectors to work with data before you can use the serial ports in this manner. See [“Configuring the Analog Audio and Balanced Digital Data Jumper Connectors”](#) on page 7 for details. The encoder will always have access to the decoder as the source of metadata even when the decoder is configured to send metadata out through one of the serial ports.

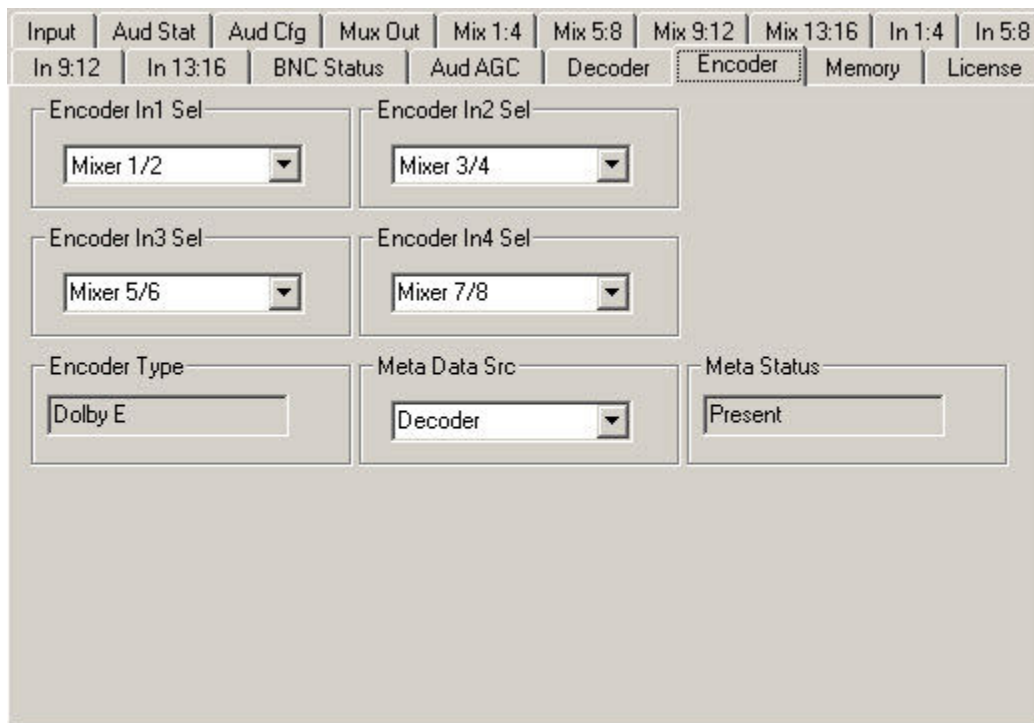

Encoder Avenue PC Menu showing that mixer output channels 1/2, 3/4, 5/6 and 7/8 are being sent to the Encoder. In this example, the encoder type is Dolby E.

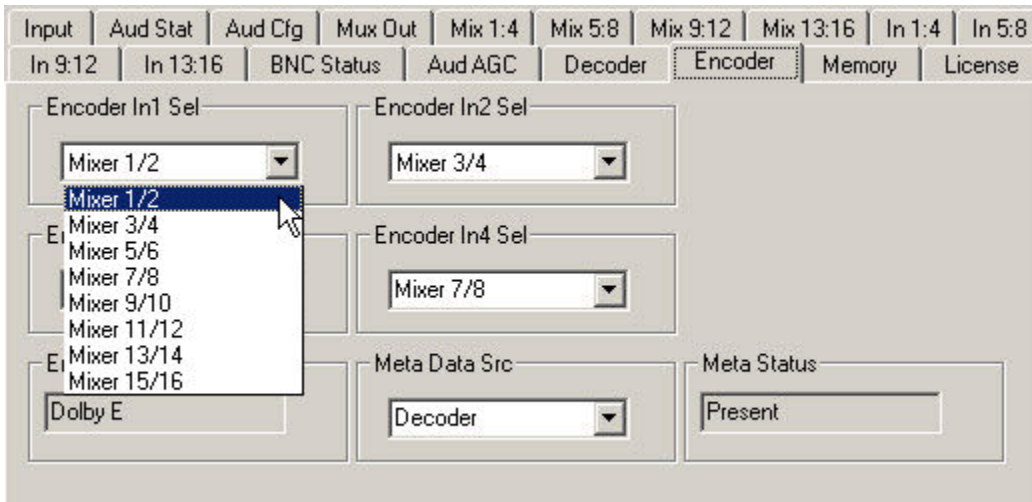

Available selections from the **Encoder In1 Sel** drop-down control. The same selections are available from the **Encoder In2 Sel**, **Encoder In3 Sel**, and **Encoder In4 Sel** drop-down controls.

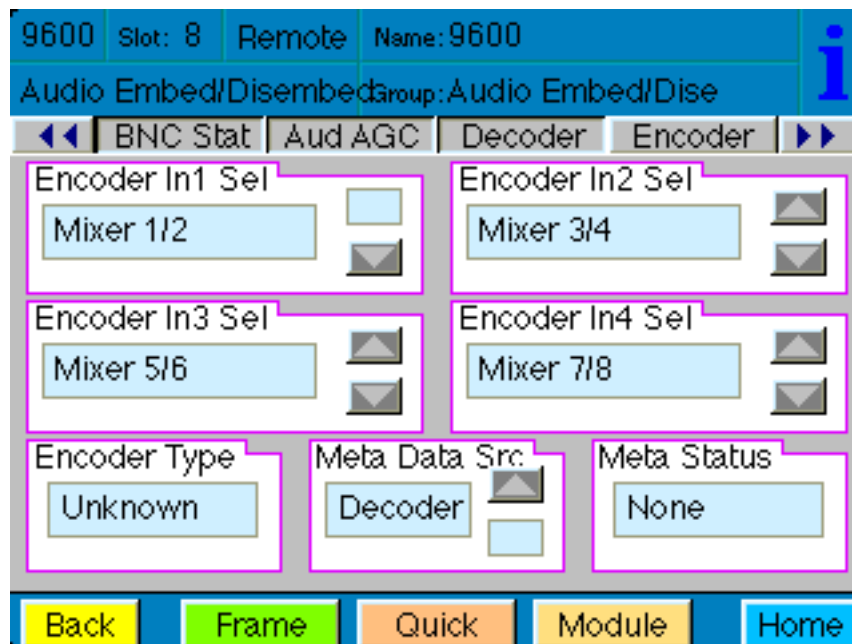

Encoder Avenue Touch Screen Menu

Memory Menu

Saving and Recalling Multiple Configurations for the 9600 Module

The Memory menu allows you to save overall module setups to five memory registers.

Select **Save**, then select one of the five memory registers Reg 1 – Reg 5. The box will turn green. The entire module setup is now saved in the selected memory register.

To recall a register, select the register box. If there is information saved, the box will turn green. The saved setup will now be loaded to the module. Up to five different module setups can be saved and recalled using the individual registers.

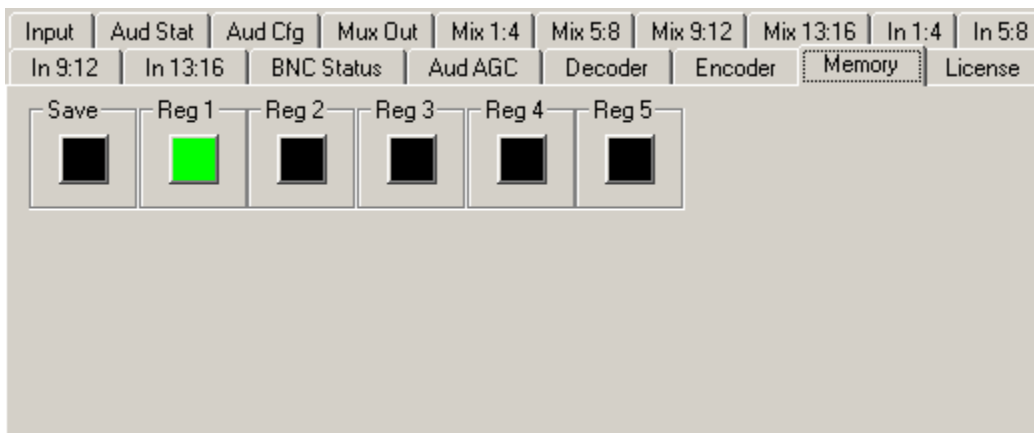

Memory Avenue PC Menu

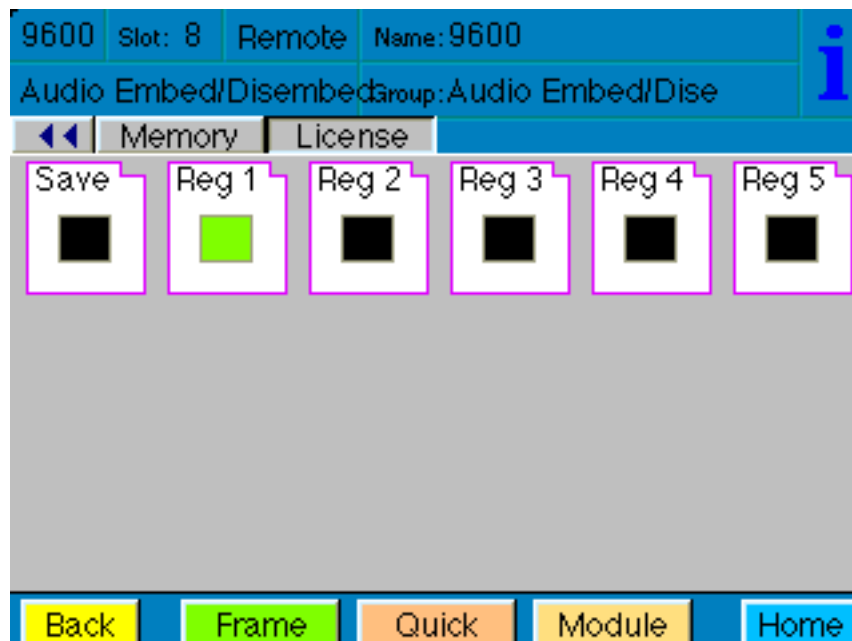

Memory Avenue Touch Screen Menu

License Menu

Use the License Menu to enter the Key and activate the LevelTrack™ Audio AGC Option.

To enter the key, enter the key provided by Ensemble Designs into the Key field, then press Enter on your keyboard. If the key you entered is valid, the Status field will display "Good." If it is invalid, the Status field will display "Invalid." If you do not enter a key and press Enter, the Status field will display "None."

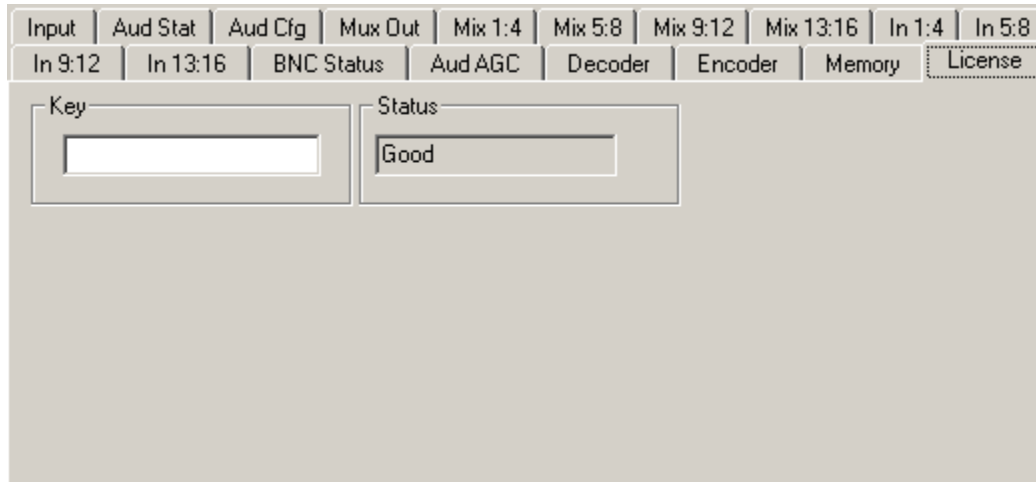

License Avenue PC Menu

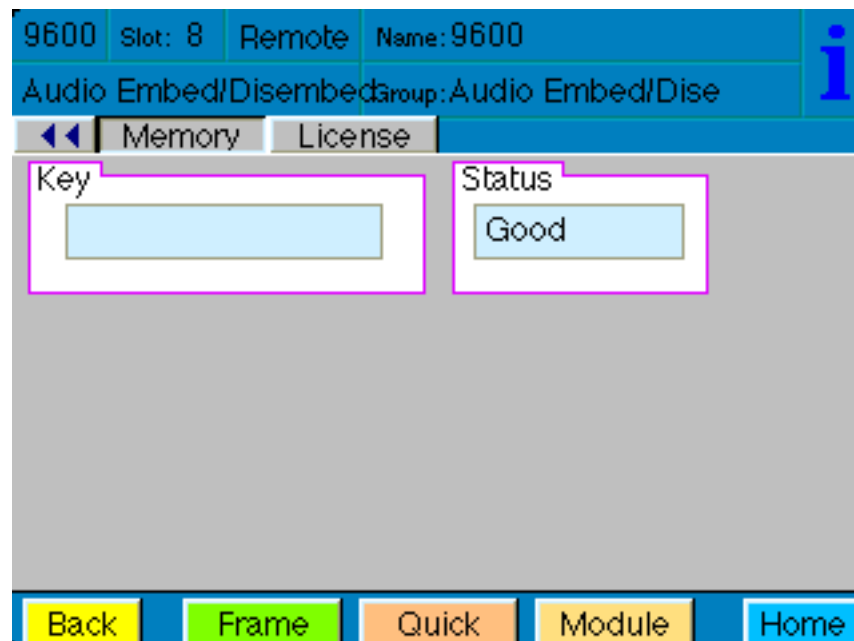

License Avenue Touch Screen Menu

Software Updating

Software upgrades for each Avenue module are available for free at the following link:

<http://www.ensembledesigns.com/support/avenue-support/avenue-software>

Use the AvenuePC software to install the software update to your Avenue module. If you do not have the required System Control Module and Avenue PC software, you can send modules back to the factory for software upgrades.

Warranty and Factory Service

This module is covered by a five year limited warranty, as stated in the main Preface of this manual. If you require service (under warranty or not), please contact Ensemble Designs and ask for customer service before you return the unit. This will allow the service technician an opportunity to provide any other suggestions for identifying the problem and to recommend possible solutions.

Tel: (530) 478-1830

Fax: (530) 478-1832

service@ensembledesigns.com

<http://www.ensembledesigns.com>

If you return equipment for repair, please get a Return Material Authorization Number (RMA) from the factory first.

Ship the product and a written description of the problem to:

Ensemble Designs, Inc.
Attention: Customer Service RMA #####
870 Gold Flat Rd.
Nevada City, CA. 95959 USA

Be sure to put your RMA number on the outside of the box.

Specifications

Input

Number	One
Signal Type	HD Serial Digital 1.485 Gb/s SMPTE 274M, 292M or 296M HD Serial Digital 2.97 Gb/s SMPTE 424M, 425M SD Serial Digital 270 Mb/s SMPTE 259M Data as per SMPTE 337M
Impedance	75 Ω
Return Loss	>15 dB DC to 1.5 GHz
Max Cable Length	
270 Mb/s	300 meters Belden 1694A
1.485 Gb/s	100 meters Belden 1694A
2.97 Gb/s	70 meters Belden 1694A
Automatic Cable Input Equalization	

Standards Supported

1080i (SMPTE 274M -4,5,6)	50, 59.94 or 60 Hz
720p (SMPTE 296M -1,2,3)	50, 59.94 or 60 Hz
1080p (SMPTE 274M -9,10,11)	23.98, 24, 25 Hz
1080p (SMPTE 424M, 425M)	50, 59.94 Hz
1080sF (RP211 -14,15,16)	23.98, 24, 25 Hz
625i 50 , 525i 59.94	
Data (SMPTE 337M)	

Output

Number	One [Three for the 9600-XV]
Signal Type	HD or SD Serial Digital, follows input
Impedance	75 Ω
Return Loss	>15 dB DC to 1.5 GHz

AES/EBU Digital Inputs

Number	Eight (total of sixteen channels) selectable as inputs or outputs [Six (total of twelve channels) for the 9600-XV]
Type	AES3id or data (SMPTE 337)
Connectorization	Coaxial, 75 Ω
Bit Depth	20 and 24 bit
Sample Rate	30 kHz to 100 kHz (sample rate converted internally to 48 kHz)
Crosstalk	<144 dB
Dynamic Range	>144 dB
Reference Level	-18 or -20 dBFS (selectable)

AES/EBU Digital Outputs

Number	Eight (total of sixteen channels) selectable as inputs or outputs [Six (total of twelve channels) for the 9600-XV]
Type	AES3id or data
Connectorization	Coaxial, 75 Ω
Bit Depth	20 and 24 bit
Sample Rate	48 kHz Synchronous to Video output
Reference Level	-18 or -20 dBFS (selectable)

Analog Audio Inputs

Number	Four (selectable as inputs or outputs)
Type	Balanced
Connectorization	15-pin D connector
Impedance	>15K Ω
Maximum Input Level	24 dBu
CMRR	>60 dB, 20 Hz to 10 KHz
Quantization	24 bits, 128 x oversampled
Sample Rate	48 KHz
Reference Level	-10 dBu or +4 dBu
Frequency Response	± 0.1 dB, 20 Hz to 20 KHz
Crosstalk	<106 dB
Dynamic Range	>106 dB

Analog Audio Outputs

Number	Four (selectable as inputs or outputs)
Type	Balanced, transformerless
Connectorization	15-pin D connector
Impedance	30 Ω
Maximum Output Level	24 dBu
Resolution	24 bits, 128 x oversampled
Reference Level	-10 dBu or +4 dBu
Frequency Response	± 0.1 dB, 20 Hz to 20 KHz
Crosstalk	<106 dB
Dynamic Range	>106 dB

Dolby Metadata Inputs/Outputs

Signal Type	Dolby metadata, RS-422, RS-485
Number	Four, selectable as inputs or outputs, share with analog audio I/O
Connectorization	HD-15, balanced

Embedded Output (In SDI Outputs)

Group Assign	Cascade or Replace
Channels	Sixteen
Bit Depth	24 Bit

General Specifications

Power Consumption	10 watts
Temperature Range	0 to 40°C ambient (all specs met)
Relative Humidity	0 to 95%, noncondensing
Altitude	0 to 10,000 ft

Glossary

AES/EBU

The digital audio standard defined as a joint effort of the Audio Engineering Society and the European Broadcast Union. AES/EBU or AES3 describes a serial bitstream that carries two audio channels, thus an AES stream is a stereo pair. The AES/EBU standard covers a wide range of sample rates and quantizations (bit depths). In television systems, these will generally be 48 KHz and either 20 or 24 bits.

AFD

Active Format Description is a method to carry information regarding the aspect ratio of the video content. The specification of AFD was standardized by SMPTE in 2007 and is now beginning to appear in the marketplace. AFD can be included in both SD and HD SDI transport systems. There is no legacy analog implementation. (See WSS).

ASI

A commonly used transport method for MPEG video streams, ASI or Asynchronous Serial Interface, operates at the same 270 Mb/s data rate as SD SDI. This makes it easy to carry an ASI stream through existing digital television infrastructure. Known more formally as DVB-ASI, this transport mechanism can be used to carry multiple program channels.

Aspect Ratio

The ratio of the vertical and horizontal measurements of an image. 4:3 is the aspect ratio for standard definition video formats and television and 16:9 for high definition. Converting formats of unequal ratios is done by letterboxing (horizontal bars) or pillar boxing (vertical pillars) in order to keep the original format's aspect ratio.

Bandwidth

Strictly speaking, this refers to the range of frequencies (i.e. the width of the band of frequency) used by a signal, or carried by a transmission channel. Generally, wider bandwidth will carry and reproduce a signal with greater fidelity and accuracy.

Beta

Sony Beta SP video tape machines use an analog component format that is similar to SMPTE, but differs in the amplitude of the color difference signals. It may also carry setup on the luminance channel.

Bit

A binary digit, or bit, is the smallest amount of information that can be stored or transmitted digitally by electrical, optical, magnetic, or other means. A single bit can take on one of two states: On/Off, Low/High, Asserted/ Deasserted, etc. It is represented numerically by the numerals 1 (one) and 0 (zero). A byte, containing 8 bits, can represent 256 different states. The binary number 11010111, for example, has the value of 215 in our base 10 numbering system. When a value is carried digitally, each additional bit of resolution will double the number of different states that can be represented. Systems that operate with a greater number of bits of resolution, or quantization, will be able to capture a

signal with more detail or fidelity. Thus, a video digitizer with 12 bits of resolution will capture 4 times as much detail as one with 10 bits.

Blanking

The Horizontal and Vertical blanking intervals of a television signal refer to the time periods between lines and between fields. No picture information is transmitted during these times, which are required in CRT displays to allow the electron beam to be repositioned for the start of the next line or field. They are also used to carry synchronizing pulses which are used in transmission and recovery of the image. Although some of these needs are disappearing, the intervals themselves are retained for compatibility purposes. They have turned out to be very useful for the transmission of additional content, such as teletext and embedded audio.

CAV

Component Analog Video. This is a convenient shorthand form, but it is subject to confusion. It is sometimes used to mean ONLY color difference component formats (SMPTE or Beta), and other times to include RGB format. In any case, a CAV signal will always require 3 connectors – either Y/R-Y/B-Y, or R/G/B.

Checkfield

A Checkfield signal is a special test signal that stresses particular aspects of serial digital transmission. The performance of the Phase Locked-Loops (PLLs) in an SDI receiver must be able to tolerate long runs of 0's and 1's. Under normal conditions, only very short runs of these are produced due to a scrambling algorithm that is used. The Checkfield, also referred to as the Pathological test signal, will "undo" the scrambling and cause extremely long runs to occur. This test signal is very useful for testing transmission paths.

Chroma

The color or chroma content of a signal, consisting of the hue and saturation of the image. See also Color Difference.

Component

In a component video system, the totality of the image is carried by three separate but related components. This method provides the best image fidelity with the fewest artifacts, but it requires three independent transmission paths (cables). The commonly used component formats are Luminance and Color Difference (Y/Pr/Pb), and RGB. It was far too unwieldy in the early days of color television to even consider component transmission.

Composite

Composite television dates back to the early days of color transmission. This scheme encodes the color difference information onto a color subcarrier. The instantaneous phase of the subcarrier is the color's hue, and the amplitude is the color's saturation or intensity. This subcarrier is then added onto the existing luminance video signal. This trick works because the subcarrier is set at a high enough frequency to leave spectrum for the luminance information. But it is not a seamless matter to pull the signal apart again at the destination in order to display it or process it. The resultant artifacts of dot crawl (also referred to as chroma crawl) are only the most obvious result. Composite television is

the most commonly used format throughout the world, either as PAL or NTSC. It is also referred to as Encoded video.

Color Difference

Color Difference systems take advantage of the details of human vision. We have more acuity in our black and white vision than we do in color. This means that we need only the luminance information to be carried at full bandwidth, we can scrimp on the color channels. In order to do this, RGB information is converted to carry all of the luminance (Y is the black and white of the scene) in a single channel. The other two channels are used to carry the "color difference". Noted as B-Y and R-Y, these two signals describe how a particular pixel "differs" from being purely black and white. These channels typically have only half the bandwidth of the luminance.

Decibel (dB)

The decibel is a unit of measure used to express the ratio in the amplitude or power of two signals. A difference of 20 dB corresponds to a 10:1 ratio between two signals, 6 dB is approximately a 2:1 ration. Decibels add while the ratios multiply, so 26 dB is a 20:1 ratio, and 14 dB is a 5:1 ratio. There are several special cases of the dB scale, where the reference is implied. Thus, dBm refers to power relative to 1 milliwatt, and dBu refers to voltage relative to .775V RMS. The original unit of measure was the Bel (10 times bigger), named after Alexander Graham Bell.

dBFS

In Digital Audio systems, the largest numerical value that can be represented is referred to as Full Scale. No values or audio levels greater than FS can be reproduced because they would be clipped. The nominal operating point (roughly corresponding to 0 VU) must be set below FS in order to have headroom for audio peaks. This operating point is described relative to FS, so a digital reference level of -20 dBFS has 20 dB of headroom before hitting the FS clipping point.

DVI

Digital Visual Interface. DVI-I (integrated) provides both digital and analog connectivity. The larger group of pins on the connector are digital while the four pins on the right are analog.

EDH

Error Detection and Handling is a method to verify proper reception of an SDI or HD-SDI signal at the destination. The originating device inserts a data packet in the vertical interval of the SDI signal and every line of the HD signal which contains a checksum of the entire video frame. This checksum is formed by adding up the numerical values of all of the samples in the frame, using a complex formula. At the destination this same formula is applied to the incoming video and the resulting value is compared to the one included in the transmission. If they match, then the content has all arrived with no errors. If they don't, then an error has occurred.

Embedded Audio

Digital Audio can be carried along in the same bitstream as an SDI or HD-SDI signal by taking advantage of the gaps in the transmission which correspond to the horizontal and vertical intervals of the television waveform. This technique can be very cost effective in transmission and routing, but

can also add complexity to signal handling issues because the audio content can no longer be treated independently of the video.

Eye Pattern

To analyze a digital bitstream, the signal can be displayed visually on an oscilloscope by triggering the horizontal timebase with a clock extracted from the stream. Since the bit positions in the stream form a very regular cadence, the resulting display will look like an eye – an oval with slightly pointed left and right ends. It is easy to see from this display if the eye is “open”, with a large central area that is free of negative or positive transitions, or “closed” where those transitions are encroaching toward the center. In the first case, the open eye indicates that recovery of data from the stream can be made reliably and with few errors. But in the closed case data will be difficult to extract and bit errors will occur. Generally it is jitter in the signal that is the enemy of the eye.

Frame Sync

A Frame Synchronizer is used to synchronize the timing of a video signal to coincide with a timing reference (usually a color black signal that is distributed throughout a facility). The synchronizer accomplishes this by writing the incoming video into a frame buffer memory under the timing direction of the sync information contained in that video. Simultaneously the memory is being read back by a timing system that is genlocked to a house reference. As a result, the timing or alignment of the video frame can be adjusted so that the scan of the upper left corner of the image is happening simultaneously on all sources. This is a requirement for both analog and digital systems in order to perform video effects or switch glitch-free in a router. Frame synchronization can only be performed within a single television line standard. A synchronizer will not convert an NTSC signal to a PAL signal, it takes a standards converter to do that.

Frequency Response

A measurement of the accuracy of a system to carry or reproduce a range of signal frequencies. Similar to Bandwidth.

H.264

The latest salvo in the compression wars is H.264 which is also known as MPEG-4 Part 10. MPEG-4 promises good results at just half the bit rate required by MPEG-2.

HD

High Definition. This two letter acronym has certainly become very popular. Here we thought it was all about the pictures – and the radio industry stole it.

HDCP

(High-bandwidth Digital Content Protection) is a content encryption system for HDMI. It is meant to prevent copyright content from being copied. Protected content, like a movie on a Blu-Ray disc is encrypted by its creator. Devices that want to display the protected content, like a television, must have an authorized key in order to decode the signal and display it. The entity that controls the HDCP standard strictly limits the kinds of devices that are allowed decryption keys. Devices that decrypt the content and provide an unencrypted copy are not allowed.

HDMI

The High Definition Multimedia Interface comes to us from the consumer marketplace where it is becoming the de facto standard for the digital interconnect of display devices to audio and video sources. It is an uncompressed, all-digital interface that transmits digital video and eight channels of digital audio. HDMI is a bit serial interface that carries the video content in digital component form over multiple twisted-pairs. HDMI is closely related to the DVI interface for desktop computers and their displays.

IEC

The International Electrotechnical Commission provides a wide range of worldwide standards. They have provided standardization of the AC power connection to products by means of an IEC line cord. The connection point uses three flat contact blades in a triangular arrangement, set in a rectangular connector. The IEC specification does not dictate line voltage or frequency. Therefore, the user must take care to verify that a device either has a universal input (capable of 90 to 230 volts, either 50 or 60 Hz), or that a line voltage switch, if present, is set correctly.

Interlace

Human vision can be fooled to see motion by presenting a series of images, each with a small change relative to the previous image. In order to eliminate the flicker, our eyes need to see more than 30 images per second. This is accomplished in television systems by dividing the lines that make up each video frame (which run at 25 or 30 frames per second) into two fields. All of the odd-numbered lines are transmitted in the first field, the even-numbered lines are in the second field. In this way, the repetition rate is 50 or 60 Hz, without using more bandwidth. This trick has worked well for years, but it introduces other temporal artifacts. Motion pictures use a slightly different technique to raise the repetition rate from the original 24 frames that make up each second of film—they just project each one twice.

IRE

Video level is measured on the IRE scale, where 0 IRE is black, and 100 IRE is full white. The actual voltages that these levels correspond to can vary between formats.

ITU-R 601

This is the principal standard for standard definition component digital video. It defines the luminance and color difference coding system that is also referred to as 4:2:2. The standard applies to both PAL and NTSC derived signals. They both will result in an image that contains 720 pixels horizontally, with 486 vertical pixels in NTSC, and 576 vertically in PAL. Both systems use a sample clock rate of 27 MHz, and are serialized at 270 Mb/s.

Jitter

Serial digital signals (either video or audio) are subject to the effects of jitter. This refers to the instantaneous error that can occur from one bit to the next in the exact position of each digital transition. Although the signal may be at the correct frequency on average, in the interim it varies. Some bits come slightly early, others come slightly late. The measurement of this jitter is given either as the amount of time uncertainty or as the fraction of a bit width. For 270 Mb/s SD video, the allowable jitter is 740 picoseconds, or 0.2 UI (Unit Interval – one bit width). For 1.485 Gb/s HD, the

same 0.2UI spec corresponds to just 135 pico seconds.

Luminance

The “black & white” content of the image. Human vision had more acuity in luminance, so television systems generally devote more bandwidth to the luminance content. In component systems, the luminance is referred to as Y.

MPEG

The Moving Picture Experts Group is an industry group that develops standards for the compression of moving pictures for television. Their work is an on-going effort. The understanding of image processing and information theory is constantly expanding. And the raw bandwidth of both the hardware and software used for this work is ever increasing. Accordingly, the compression methods available today are far superior to the algorithms that originally made the real-time compression and decompression of television possible. Today, there are many variations of these techniques, and the term MPEG has to some extent become a broad generic label.

Metadata

This word comes from the Greek, meta means ‘beyond’ or ‘after’. When used as a prefix to ‘data’, it can be thought of as ‘data about the data’. In other words, the metadata in a data stream tells you about that data – but it is not the data itself. In the television industry, this word is sometimes used correctly when, for example, we label as metadata the timecode which accompanies a video signal. That timecode tells you something about the video, i.e. when it was shot, but the timecode in and of itself is of no interest. But in our industry’s usual slovenly way in matters linguistic, the term metadata has also come to be used to describe data that is associated with the primary video in a datastream. So embedded audio will (incorrectly) be called metadata when it tells us nothing at all about the pictures. Oh well.

Multi-mode

Multi-mode fibers have a larger diameter core than single mode fibers (either 50 or 62.5 microns compared to 9 microns), and a correspondingly larger aperture. It is much easier to couple light energy into a multi-mode fiber, but internal reflections will cause multiple “modes” of the signal to propagate down the fiber. This will degrade the ability of the fiber to be used over long distances. See also Single Mode.

NTSC

The color television encoding system used in North America was originally defined by the National Television Standards Committee. This American standard has also been adopted by Canada, Mexico, Japan, Korea, and Taiwan. (This standard is referred to disparagingly as Never Twice Same Color.)

Optical

An optical interface between two devices carries data by modulating a light source. This light source is typically a laser or laser diode (similar to an LED) which is turned on and off at the bitrate of the datastream. The light is carried from one device to another through a glass fiber. The fiber’s core acts as a waveguide or lightpipe to carry the light energy from one end to another. Optical transmission has two very significant advantages over metallic copper cables. Firstly, it does not require that the

two endpoint devices have any electrical connection to each other. This can be very advantageous in large facilities where problems with ground loops appear. And secondly, and most importantly, an optical interface can carry a signal for many kilometers or miles without any degradation or loss in the recovered signal. Copper is barely useful at distances of just 1000 feet.

Oversampling

A technique to perform digital sampling at a multiple of the required sample rate. This has the advantage of raising the Nyquist Rate (the maximum frequency which can be reproduced by a given sample rate) much higher than the desired passband. This allows more easily realized anti-aliasing filters.

PAL

During the early days of color television in North America, European broadcasters developed a competing system called Phase Alternation by Line. This slightly more complex system is better able to withstand the differential gain and phase errors that appear in amplifiers and transmission systems. Engineers at the BBC claim that it stands for Perfection At Last.

Pathological Test Pattern – see Checkfield

Progressive

An image scanning technique which progresses through all of the lines in a frame in a single pass. Computer monitors all use progressive displays. This contrasts to the interlace technique common to television systems.

Return Loss

An idealized input or output circuit will exactly match its desired impedance (generally 75 ohms) as a purely resistive element, with no reactive (capacitive or inductive) elements. In the real world, we can only approach the ideal. So, our real inputs and outputs will have some capacitance and inductance. This will create impedance matching errors, especially at higher frequencies. The Return Loss of an input or output measures how much energy is returned (reflected back due to the impedance mismatch). For digital circuits, a return loss of 15 dB is typical. This means that the energy returned is 15 dB less than the original signal. In analog circuits, a 40 dB figure is expected.

RGB

RGB systems carry the totality of the picture information as independent Red, Green, and Blue signals. Television is an additive color system, where all three components add to produce white. Because the luminance (or detail) information is carried partially in each of the RGB channels, all three must be carried at full bandwidth in order to faithfully reproduce an image.

ScH Phase

Used in composite systems, ScH Phase measures the relative phase between the leading edge of sync on line 1 of field 1 and a continuous subcarrier sinewave. Due to the arithmetic details of both PAL and NTSC, this relationship is not the same at the beginning of each frame. In PAL, the pattern repeats every 4 frames (8 fields) which is also known as the Bruch Blanking sequence. In NTSC, the repeat is every 2

frames (4 fields). This creates enormous headaches in editing systems and the system timing of analog composite facilities.

Setup

In the NTSC Analog Composite standard, the term Setup refers to the addition of an artificial offset or pedestal to the luminance content. This places the Black Level of the analog signal 54 mV (7.5 IRE) positive with respect to ground. The use of Setup is a legacy from the early development of television receivers in the vacuum tube era. This positive offset helped to prevent the horizontal retrace of the electron beam from being visible on the CRT, even if Brightness and Contrast were mis-adjusted. While the use of Setup did help to prevent retrace artifacts, it did so at the expense of dynamic range (contrast) in the signal because the White Level of the signal was not changed.

Setup is optional in NTSC systems, but is never used in PAL systems (see 'Perfection' characteristic of PAL). This legacy of Setup continues to persist in North American NTSC systems, while it has been abandoned in Japan.

In the digital component world (SD and HD SDI) there is obviously no need for, and certainly every reason to avoid, Setup. In order for the interfaces between analog and digital systems to operate as transparently as possible, Setup must be carefully accounted for in conversion products. When performing analog to digital conversion, Setup (if present) must be removed and the signal range gained up to account for the 7.5% reduction in dynamic range. And when a digital signal is converted back to analog form, Setup (if desired on the output) must be created by reducing the dynamic range by 7.5% and adding the 54 mV positive offset. Unfortunately, there is no truly foolproof algorithm to detect the presence of Setup automatically, so it's definitely a case of installer beware.

SDI

Serial Digital Interface. This term refers to inputs and outputs of devices that support serial digital component video. This could refer to standard definition at 270 Mb/s, HD SDI or High Definition Serial Digital video at 1.485 Gb/s, or to the newer 3G standard of High Definition video at 2.97 Gb/s.

SMPTE

The Society of Motion Picture and Television Engineers is a professional organization which has done tremendous work in setting standards for both the film and television industries. The term "SMPTE" is also shorthand for one particular component video format - luminance and color difference.

Single Mode

A Single mode (or mono mode) optical fiber carries an optical signal on a very small diameter (9 micron) core surrounded with cladding. The small diameter means that no internally reflected lightwaves will be propagated. Thus only the original "mode" of the signal passes down the fiber. A single mode fiber used in an optical SDI system can carry a signal for up to 20 kilometers. Single mode fibers require particular care in their installation due to the extremely small optical aperture that they present at splice and connection points. See also Multi-mode.

TBC

A Time Base Corrector is a system to reduce the Time Base Error in a signal to acceptable levels. It accomplishes this by using a FIFO (First In, First Out) memory. The incoming video is written into the

memory using its own jittery timing. This operation is closely associated with the actual digitization of the analog signal because the varying position of the sync timing must be mimicked by the sampling function of the analog to digital converter. A second timing system, genlocked to a stable reference, is used to read the video back out of the memory. The memory acts as a dynamically adjusting delay to smooth out the imperfections in the original signal's timing. Very often a TBC will also function as a Frame Synchronizer. See also Frame Sync.

Time Base Error

Time base error is present when there is excessive jitter or uncertainty in the line to line output timing of a video signal. This is commonly associated with playback from video tape recorders, and is particularly severe with consumer type heterodyne systems like VHS. Time base error will render a signal unusable for broadcast or editing purposes.

Timecode

Timecode, a method to uniquely identify and label every frame in a video stream, has become one of the most recognized standards ever developed by SMPTE. It uses a 24 hour clock, consisting of hours, minutes, seconds, and television frames. Originally recorded on a spare audio track, this 2400 baud signal was a significant contributor to the development of video tape editing. We now refer to this as LTC or Longitudinal Time Code because it was carried along the edge of the tape. This allowed it to be recovered in rewind and fast forward when the picture itself could not. Timecode continues to be useful today and is carried in the vertical interval as VITC, and as a digital packet as DVITC. Timecode is the true metadata.

Tri-Level Sync

For many, many years, television systems used composite black as a genlock reference source. This was a natural evolution from analog systems to digital implementations. With the advent of High Definition television, with even higher data rates and tighter jitter requirements, problems with this legacy genlock signal surfaced. Further, a reference signal with a 50 or 60 Hz frame rate was useless with 24 Hz HD systems running at film rates. Today we can think of composite black as a bi-level sync signal – it has two levels, one at sync tip and one at blanking. For HD systems, Tri-Level Sync, which has the same blanking level (at ground) of bi-level sync, but the sync pulse now has both a negative and a positive element. This keeps the signal symmetrically balanced so that its DC content is zero. And it also means that the timing pickoff point is now at the point where the signal crosses blanking and is no longer subject to variation with amplitude. This makes Tri-Level Sync a much more robust signal and one which can be delivered with less jitter.

USB

The Universal Serial Bus, developed in the computer industry to replace the previously ubiquitous RS-232 serial interface, now appears in many different forms and with many different uses. It actually forms a small local area network, allowing multiple devices to coexist on a single bus where they can be individually addressed and accessed.

VGA

Video Graphics Array. Traditional 15-pin, analog interface between a PC and monitor.

Word Clock

Use of Word Clock to genlock digital audio devices developed in the audio recording industry. Early digital audio products were interconnected with a massive parallel connector carrying a twisted pair for every bit in the digital audio word. A clock signal, which is a square wave at the audio sampling frequency, is carried on a 75 ohm coaxial cable. Early systems would daisychain this 44.1 or 48 kilohertz clock from one device to another with coax cable and Tee connectors. On the rising edge of this Word Clock these twisted pairs would carry the left channel, while on the falling edge, they would carry the right channel. In most television systems using digital audio, the audio sample clock frequency (and hence the 'genlock' between the audio and video worlds) is derived from the video genlock signal. But products that are purely audio, with no video reference capability, may still require Word Clock.

WSS

Wide Screen Signaling is used in the PAL/625 video standards, both in analog and digital form, to convey information about the aspect ratio and format of the transmitted signal. Carried in the vertical interval, much like closed captioning, it can be used to signal a television receiver to adjust its vertical or horizontal sizing to reflect incoming material. Although an NTSC specification for WSS exists, it never achieved any traction in the marketplace.

YUV

Strictly speaking, YUV does not apply to component video. The letters refer to the Luminance (Y), and the U and V encoding axes using in the PAL composite system. Since the U axis is very close to the B-Y axis, and the V axis is very close to the R-Y axis, YUV is often used as a sort of shorthand for the more long-winded "Y/R-Y/B-Y".

Y/Cr/Cb

In digital component video, the luminance component is Y, and the two color difference signals are Cr (R-Y) and Cb (B-Y).

Y/Pr/Pb

In analog component video, the image is carried in three components. The luminance is Y, the R-Y color difference signal is Pr, and the B-Y color difference signal is Pb.