

AVENUE

Avenue[®] signal integration system

Model 8400 Series Video and Audio Processing Data Pack

ENSEMBLE
DESIGNS

Revision 4.1 SW v2.2.6

This data pack provides detailed installation, configuration and operation information for the **8400 Series Video Processing Synchronizer** module along with the **8410, 8415,** and **8510 Audio Processing** and **8520 DNR** option submodules as part of the Avenue Signal Integration System.

The module information in this data pack is organized into the following sections:

- 8400 Series Overview
- Applications
- Installation
 - Configuring Rear BNCs
- Cabling
- Module Configuration and Control
 - Front Panel Controls and Indicators
 - Avenue PC Remote Control
 - Avenue Touch Screen Remote Control
- Troubleshooting
- Software Updating
- Warranty and Factory Service
- Specifications

8400 SERIES OVERVIEW

The 8400 Video Processing Frame Synchronizer, along with its optional submodules, is a real "do it all" module, it's the total solution for digital video and digital audio processing. Uncompromising attention to image quality and fidelity means that it does what you need and keeps your signals pristine.

The 8400 has SDI I/O with a rugged frame synchronizer and a powerful proc amp. An infinitely adjustable timing system genlocks to your house reference. Optional Audio Processors and an optional Digital Noise Reducer round out the 8400 module.

The SDI input is carried at full uncompressed bandwidth throughout the entire module, and EDH monitoring of the digital input alerts you to any incoming problem. Complete control over signal levels is provided. Input video is synchronized to your house reference by the 8400's built-in Frame Synchronizer.

The 8400 has a full-featured Proc Amp for adjustment of every signal parameter. Proc controls include Video and Chroma Gain, NTSC style hue rotation, Black Balance, and pedestal. Black and White clips can be set to prevent excessive signal excursions. To help optimize the settings in the Proc Amp, a Split Screen mode allows you to compare the processed output with the original material.

A Detail Enhancer recovers information that has been lost due to poor frequency response in upstream systems. Certain values represented in serial digital component may be illegal in the NTSC or PAL composite domains. The Predictive Composite Clipper mode identifies picture elements that would be illegal in analog composite, and limits color saturation and luminance excursions. Work done in digital component will look its best when viewed in composite. Selective (toothed) vertical blanking lets you choose to pass or strip content in the vertical interval on a line by line and field by field basis.

The 8520 Digital Video Noise Reducer (DNR) is an optional sub module that can be added to the 8400 Video Processing Frame Synchronizer. The noise reduction process is downstream of the 8400 Proc Amp controls. It only adds 4 microseconds to the throughput delay of the 8400, so it does not introduce problems with system timing. The 8520 DNR is motion and scene adaptive. It removes unwanted noise and artifacts, making it perfect for MPEG compression preprocessing and satellite or ENG feeds.

Several forms of noise reduction are employed to ensure the best possible performance. Recursive Temporal Noise filtering includes Simple Recursive, Motion Adaptive and Motion Adaptive with Impulse filter. Controls are provided for maximum signal to noise improvement and for noise threshold. They can be set manually or run in automatic mode.

Because the 8400 is an Avenue module, every function and parameter can be controlled from an Avenue Touch Screen, Express Control Panel, or the Avenue PC Control Application. While it can be used to control any Avenue module, the Express Panel really shines when used with the 8400 Signal Acquisition system modules. With dedicated video, chroma, pedestal, and hue knobs, live shading is easy. The continuous rotation velocity sensitive knobs are responsive and dependable. Audio levels for multiple groups are easily accessed as well. All other parameters, including timing and audio delay, are accessed through an intuitive menu interface.

8400 module memory registers can be used to save the complete configuration of the module, making it easy to change instantly between different configurations.

Modules at software version 2.2.0 or later support SNMP (Simple Network Management Protocol) monitoring. For each applicable signal processing module, module, signal, and reference status are reported. For complete details on using SNMP monitoring, refer to the **Avenue System Overview** in the manual that accompanies each frame.

One of three types of Audio Processing submodules can be installed on the 8400 module. The audio processors have also been designed to provide superior handling of embedded audio. The disembedder on the input side follows the timing of the SDI input, even if that input is asynchronous to the house reference. The embedder on the output side is synchronous to house. This allows embedded audio to be safely bypassed around the video Framestore with the lip sync properly preserved. Embedded audio content is properly re-synchronized. The audio processors have built in sample rate conversion allowing usage of asynchronous AES inputs. Synchronous AC-3 or Dolby-E audio signals may also be used.

The **8410 4 Channel Audio Processor** shown in the block diagram below is a submodule with flexible architecture that addresses a wide range of audio handling needs. The submodule accepts two external AES audio inputs and one embedded audio group from the SDI video input. Two outputs can be routed to the AES outputs while four outputs can also be embedded into the SDI output signal.

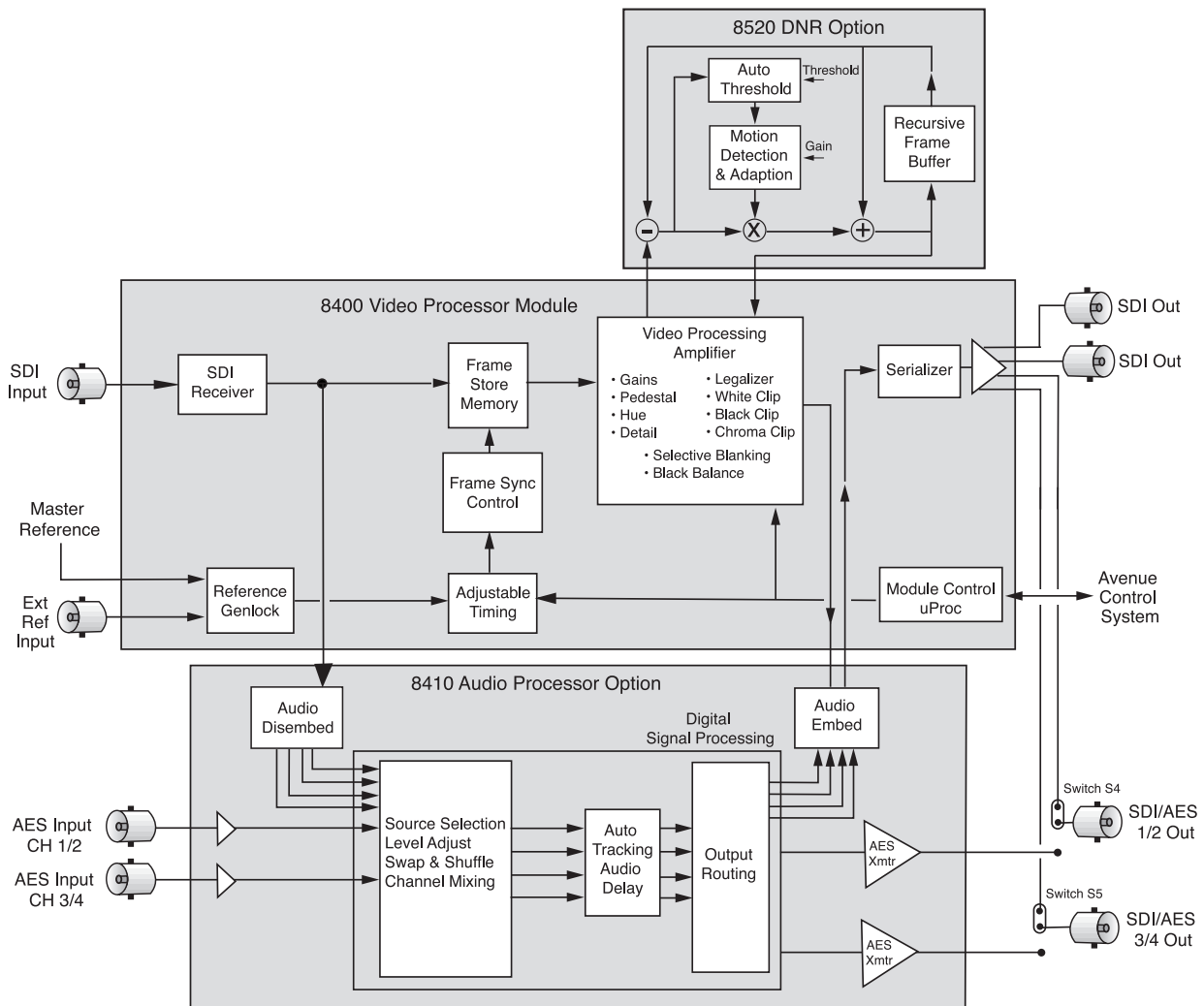

Alternately, the 8415 or 8510 Audio Processor Options can be used with the 8400.

8400 Series Functional Block Diagram with 8410 and 8420 Options

The **8415 Audio Processor** submodule shown below provides eight channels of digital audio processing. Digital audio inputs to the 8415 can come from four AES ports and/or disembedded from the 601 SDI input stream. After processing, digital outputs in both AES and embedded form are possible.

There are four AES ports, using the four AES BNC connectors on the rear of the chassis. When an 8415 is installed, these BNCs become bi-directional ports. Each of them can either be an AES input or an AES output. These four AES ports are associated with pairs of channels: Ch 1/2, Ch 3/4, Ch 5/6, and Ch 7/8. A port will become an output if it has not been chosen as an AES input in the **Aud In A** and **B** menus.

There are two disembedders on the input side of the 8415 referred to as A and B. These disembedders are being fed the 601 SDI video input stream in parallel and each of them can be independently targeted to any of the four possible groups. The A disembedder will produce two pairs of audio signals, referred to as SDI 1/2 and SDI 3/4.

The B disembedder will also produce two pairs of audio signals referred to as SDI 5/6 and SDI 7/8. In the B disembedder, the SDI 5/6 pair corresponds to the first and second channels in the selected group and SDI 7/8 is taken from the third and fourth channels in that group.

The disembedded audio can then be processed with level adjustment, channel mixing, shuffling, and automatic tracking of the delay imposed on the video channel. It can then be embedded into the video signal downstream of the the frame synchronizer, proc amp, and DNR functions on the 8400 module.

There are two embedders referred to as A and B to support the eight channels of audio, one for each group. The embedders are placed in series with the A embedder first and the B embedder second. Each embedder must be configured for operating mode and the desired group (1 – 4) in which to embed the audio.

(Note that using the 8415 requires Ave PC software version 2.0.4 and higher and the Control module must be running version 2.0.5 or higher. These versions can be downloaded from the Ensemble website.)

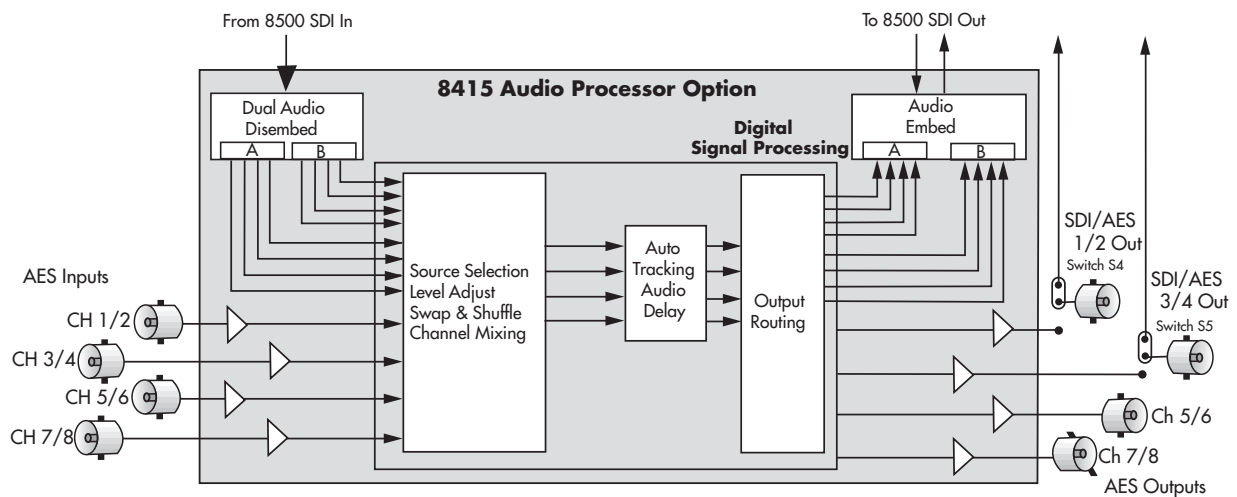

8415 Audio Submodule Block Diagram

The configuration parameters for the embedders in the Audio Out menu are not identical. There is no **Replace All** function for the B embedder as this function occurs in the upstream embedder A.

The **8510 4 Channel Audio Processor** submodule shown below does everything the 8410 does, plus it provides analog audio I/O. The 8510 accepts four channels of balanced analog audio which are digitized at 24 bits of resolution. Two AES inputs provide four channels of digital audio to the input selector. Embedded audio (4 channels) is also available from the SDI input signal. AES audio can be routed to two AES outputs and embedded into the SDI output signal. Analog audio can be set up for four balanced inputs, four balanced outputs, or two analog inputs and two analog outputs

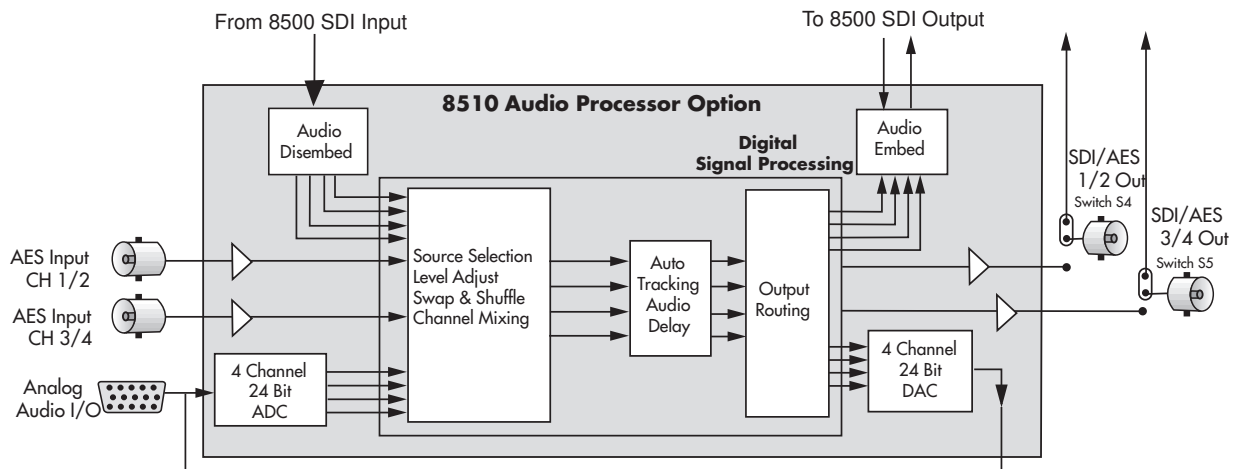

8510 Audio Submodule Block Diagram

There are two BNCs on the rear module that can be configured with onboard switches. The AES 1/2 and 3/4 outputs (with the 8410 or 8510 submodule installed) can be set independently as SDI video or AES outputs. With the 8415 submodule installed, the AES 5/6 and 7/8 outputs can be set independently as SDI video or AES outputs.

APPLICATIONS

This section provides some typical applications for utilizing the full versatility of the 8400 Video Processor module and the optional submodules, the 8410, 8415, and 8510 Audio Processor and the 8520 DNR. Configuration of these applications is covered in the **MODULE CONFIGURATION AND CONTROL** section later in this manual.

Satellite or Microwave Reception

As illustrated in the block diagram below, the 8400 will accept input from a serial digital receiver. The SDI input signal will now be locked to house and fully timeable. The 8520 DNR submodule with its Adaptive Motion Detection can be employed to clean up noisy video.

Proper audio/video timing can be assured when the tracking audio delay of the 8410 Audio Processor is employed. Any timing or delay modifications to the video are tracked by the 8410 whether you wish to use disembedded audio or audio input from an AES source. Properly timed audio from any of these sources is available directly when routed to the AES outputs, or it can be re-embedded back onto the SDI video stream. A fixed delay of up to 1000mS can be inserted by the 8410 to correct for signals which have previously passed through frame stores without audio delay compensation.

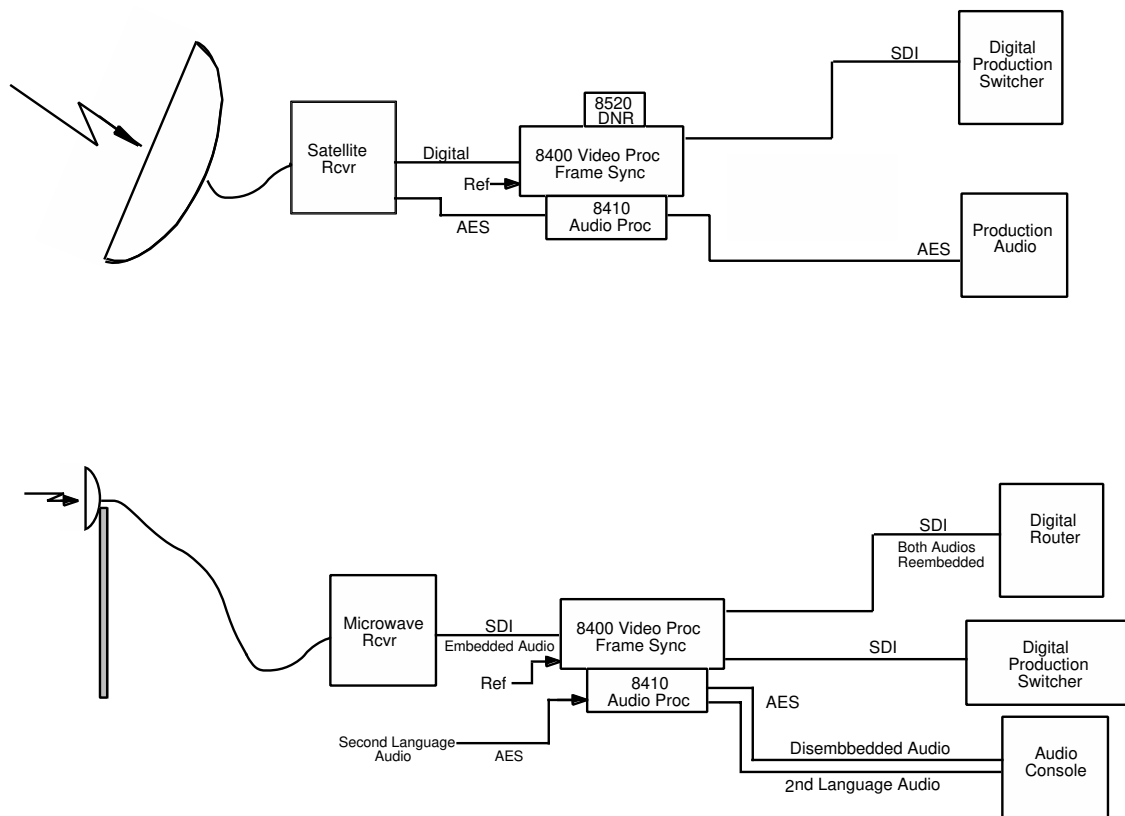

Satellite or Microwave Application Block Diagram

News / ENG Vehicle

News or ENG systems may use a combination of 8400 and 8500 modules. While the 8400 has SDI I/O, the 8500 has SDI, component analog and composite analog I/O. The wide variety of input feeds often encountered can be easily handled with an Avenue system. Robust signal handling ensures proper time base correction for nearly any source from a consumer VHS machine to an unlocked portable camera. Proc Amp functions in the 8400 include video and chroma gain and pedestal, NTSC style hue rotation and a predictive video signal legalizer. Noisy signals can be cleaned up effectively with the motion and scene adaptive 8520 DNR. There are operator controls for many choices including automatic and manual modes. In the manual mode noise reduction factor is adjustable as is the noise threshold. The show noise and split screen selections allow viewing of effectiveness of your DNR settings.

Audio is ingested by the 8410 or 8510 Audio Processor submodule from analog (8510 only) or AES sources and/or disembedded from the SDI video stream. The internal four channel audio mixer/router provides level control, mixing of sources and nearly unlimited swap or shuffle of channels. The 8400 and all other modules may be monitored and adjusted with the comprehensive Avenue control system. Graphical interface is utilized with the Avenue PC application running on a laptop or desktop, while the Avenue Touch Screen with touch and rotary controls can be simultaneously used.

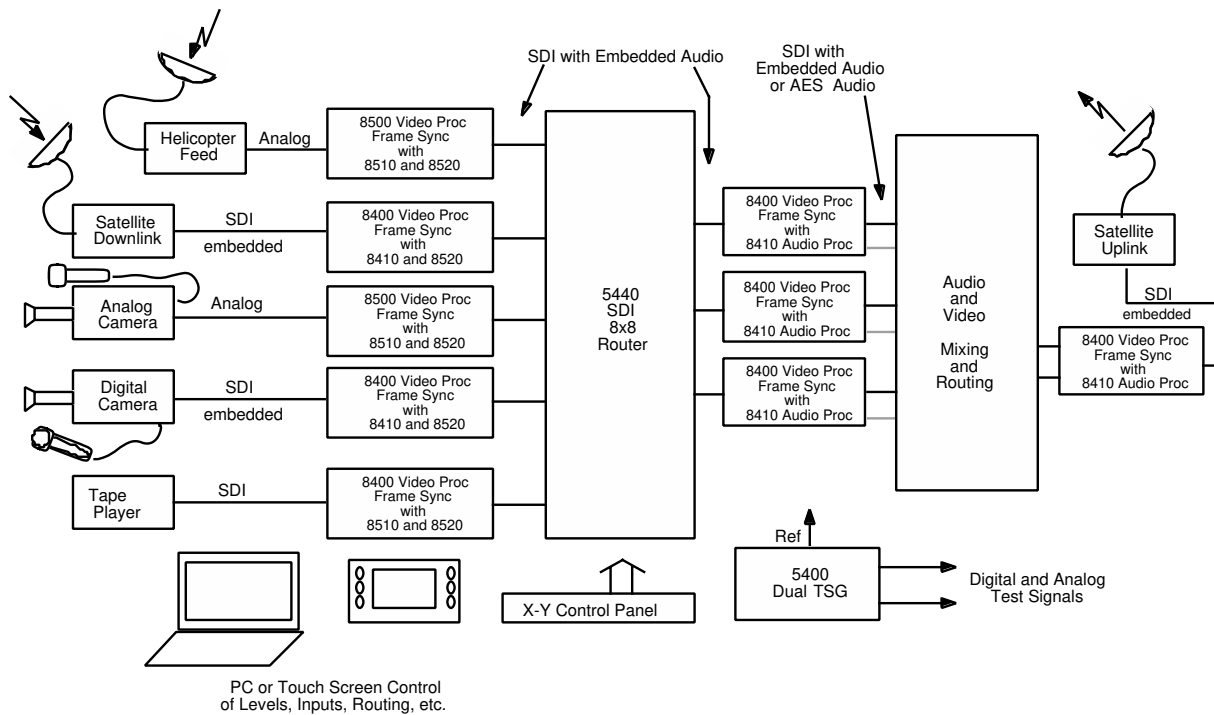

Remote Truck/OB Van Operation

A convenient and flexible interconnect to a Remote Truck or OB Van is assured with use of the 8400 and 8500 Video Processing Frame Synchronizers (shown below). An 8500 input may be analog component, composite or SDI, timed to house or asynchronous. The 8400 has SDI I/O and is targeted specifically for exclusively digital applications.

Reference is supplied to the 8400 and the output is fully timeable in relation to this reference. The 8520 DNR submodule has Adaptive Motion Detection and can be employed to clean up noisy video often found in remote situations.

Using the 8410, AES audio inputs or audio embedded on the SDI stream can be used. Disembedding and re-embedding of audio to the SDI stream is handled by the 8410 Audio Processor option submodule. Most any combination of channel shuffle, mixing and gain riding can also be done. The complete range of mix and level control facilities in the 8410 permit these outputs to be the same as the re-embedded audio, or any other combination of audio channels.

At the output end of the Remote Truck the 8400 is again used to provide a stable feed to microwave or fiber.

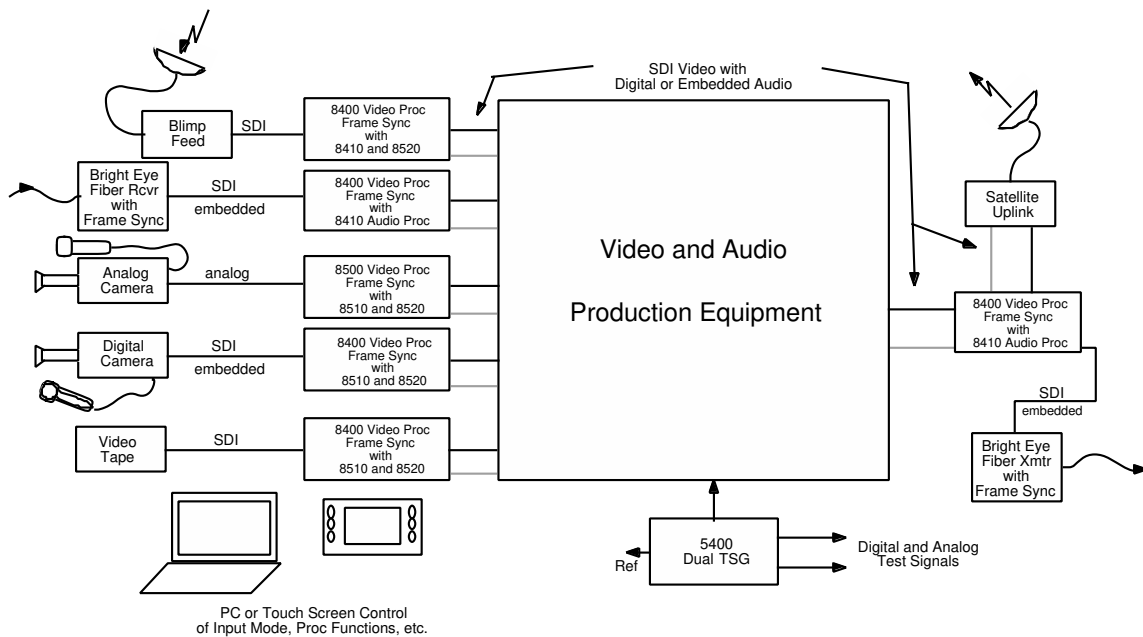

Remote Truck/OB Van Application

INSTALLATION

Rear Module BNC Configuration

There are two configurable rear BNC connectors that can be set using onboard switches on the rear of the 8400 circuit board for the choices outlined below. AES outputs will depend on the type of submodule installed. Refer to the illustration on the next page.

- **AES 1/2 Out /SDI Out BNC (8410 and 8510 submodule) or AES 5/6/SDI (8415 submodule) Configuration** – Switch S4 on the rear of the 8400 circuit board allows the BNC labeled **AES 1/2 Out/SDI** or **AES 5/6/SDI BNC** to output either AES audio or the processed SDI signal of the module (identical to the other SDI outputs). Set the toggle switch to **AES** to configure the BNC for AES out or set to **SDI** for the SDI output. The default setting for this switch set at the factory is **AES**.
- **AES 3/4 Out /SDI Out BNC (8410 and 8510 submodule) or AES 7/8/SDI (8415 submodule) Configuration** – Switch S5 on the rear of the 8400 circuit board allows the BNC labeled **AES 3/4 Out/SDI** or **AES 7/8/SDI BNC** to output either AES audio or the processed SDI signal of the module (identical to the other SDI outputs). Set the toggle switch to **AES** to configure the BNC for AES out or set to **SDI** for the SDI output. The default setting for this switch is **AES**.

8410, 8415, or 8510 Audio and 8520 DNR Submodule Installation

The optional 8400 Series submodules install on the component side of the 8400 Video Processing module circuit board. If the options are ordered with the 8400 module, they will come already installed.

To install the 8410, 8415, or 8510 audio submodule, locate the three connectors on the left side of the circuit board as shown below and line the connectors up, checking the alignment. Press carefully into place to seat the submodule.

To install the 8520 DNR submodule, locate the **UP** arrows on the circuit board and the submodule. Line up the submodule with the two connectors, matching the **UP** arrows and press carefully to seat the submodule.

8400 Video Processing Module

Plug the 8400 module into any one of the slots in the 1 RU or 3 RU frame and install the plastic overlay provided onto the corresponding group of rear BNC connectors associated with the module location. Note that the plastic overlay has an optional adhesive backing for securing it to the frame. Use of the adhesive backing is only necessary if you would like the location to be permanent and is not recommended if you need to change module locations. This module may be hot-swapped (inserted or removed) without powering down or disturbing performance of the other modules in the system.

Model 8400 Series Modules

Set toggle switches to configure BNCs on the rear module.

S4 and S5 will depend on the type of audio processor submodule installed.

S4 (8410/8510 — AES 1/2 or SDI) or (8415 — AES 5/6 or SDI)

S5 (8410/8510 — AES 3/4 or SDI) or (8415 — AES 7/8 or SDI)

Match arrows on submodule and circuit board.

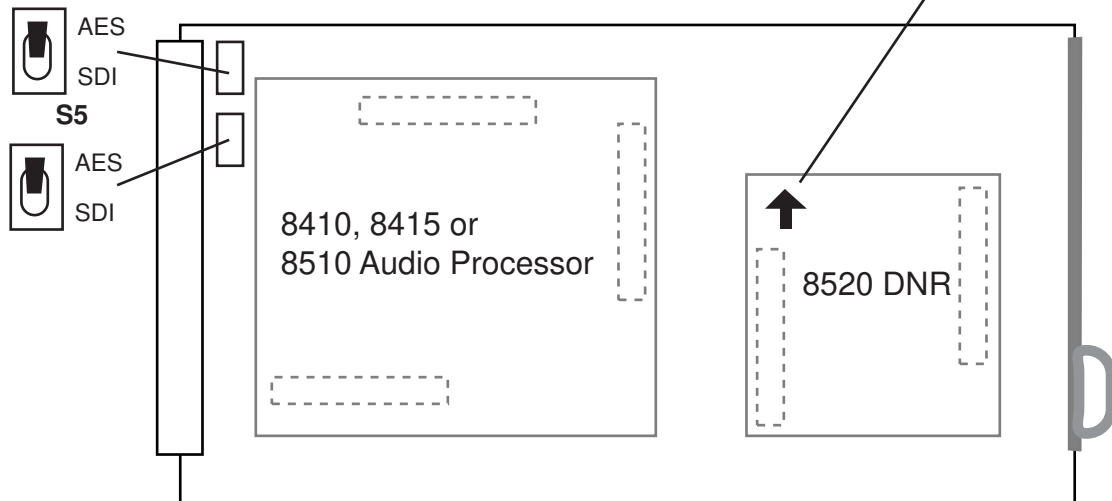

Configure Rear BNCs and Submodule Installation

CABLING

Refer to the **3 RU and 1 RU Backplane with 8410 and 8510 Audio Submodule** or **3 RU and 1 RU Backplane with 8415 Audio Submodule** on the following page for cabling instructions. Note that unless stated otherwise, the 1 RU cabling explanations are identical to those given in the 3 RU diagram.

Configure the two BNCs as described above and follow the correct cabling procedures depending on how these switches have been configured.

3 RU Backplane With 8410 or 8510 Audio Submodule

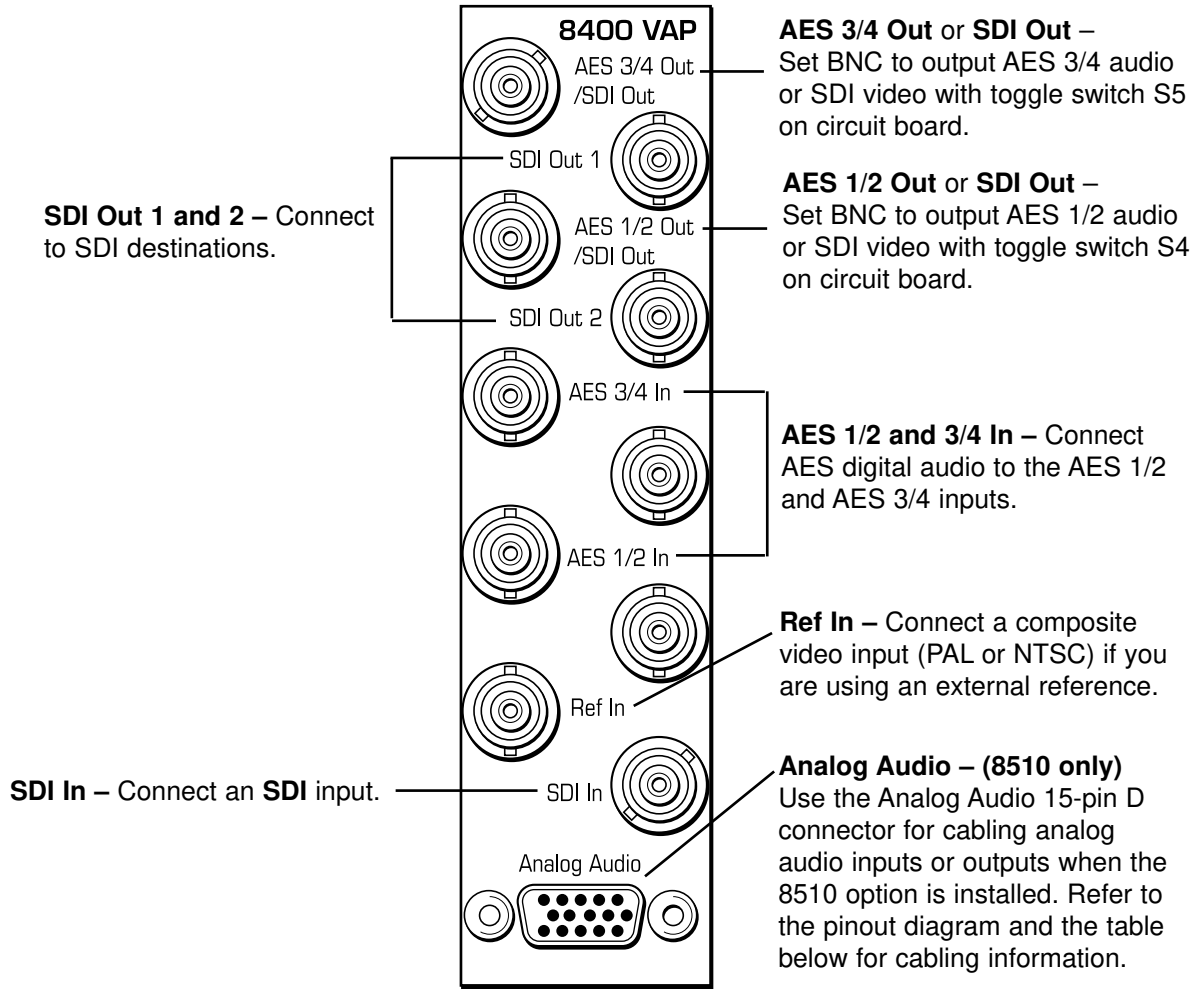

Analog Audio Pinouts				
Signal	Pins	Input	Output	2 In/2Out
Aud 1 +, -, G	1, 2, 7	Input 1	Output 1	Input 1
Aud 2 +, -, G	5, 4, 8	Input 2	Output 2	Input 2
Aud 3 +, -, G	11, 12, 9	Input 3	Output 3	Output 1
Aud 4 +, -, G	15, 14, 10	Input 4	Output 4	Output 2

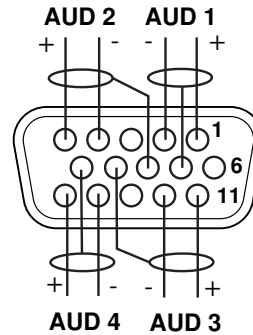

1 RU Backplane With 8410 or 8510 Audio Submodule

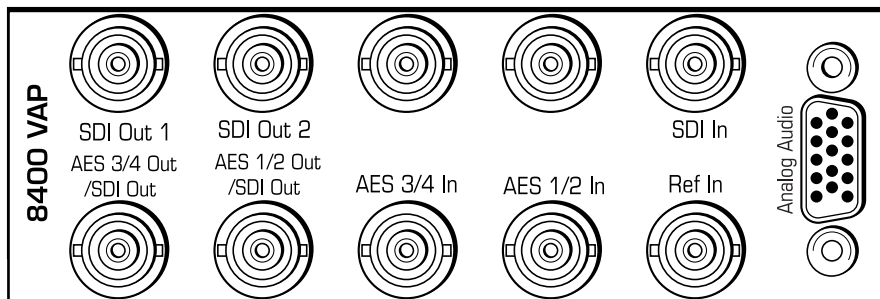

3 RU Backplane With 8415 Audio Submodule

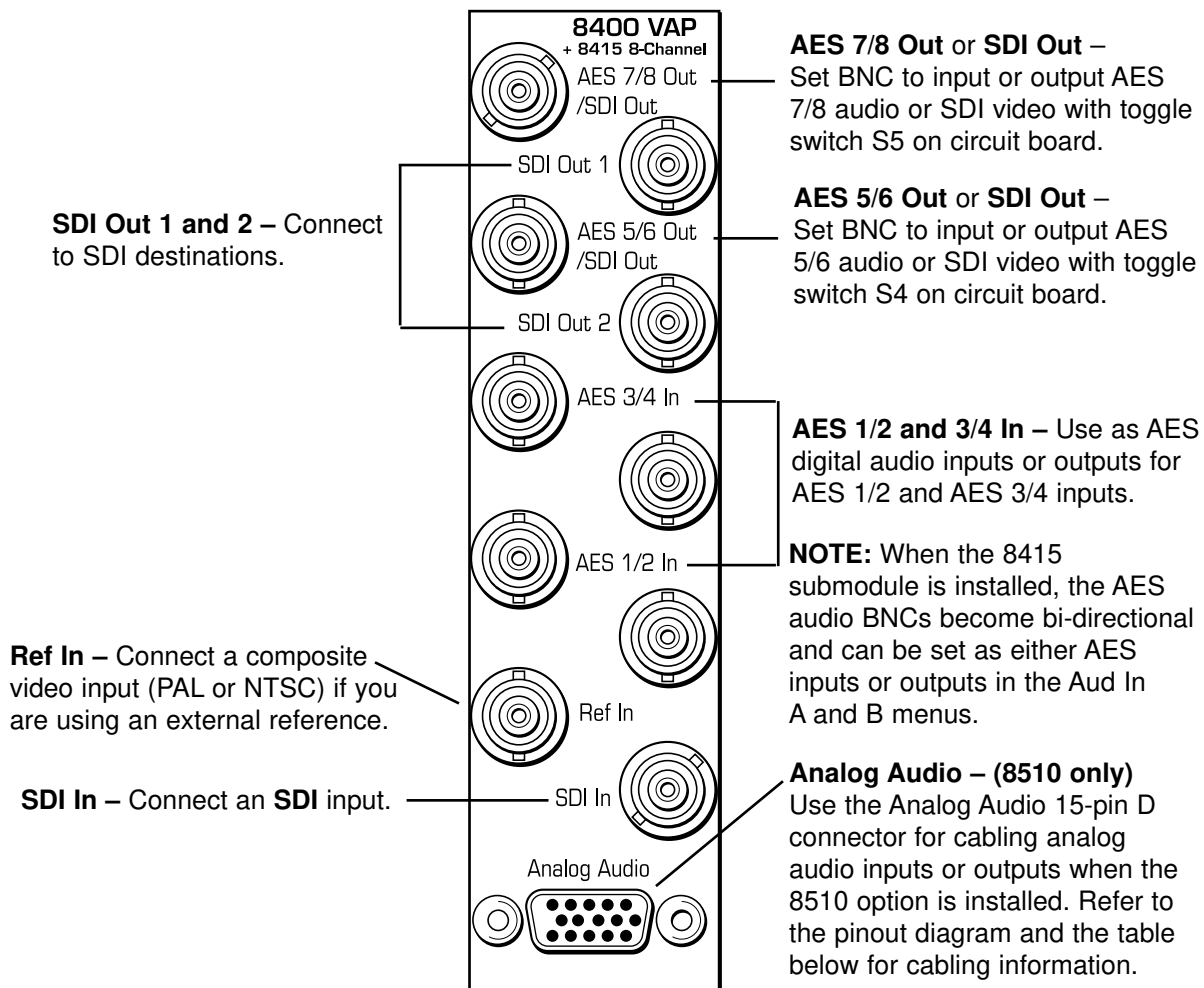

Analog Audio Pinouts				
Signal	Pins	Input	Output	2 In/2Out
Aud 1 +, -, G	1, 2, 7	Input 1	Output 1	Input 1
Aud 2 +, -, G	5, 4, 8	Input 2	Output 2	Input 2
Aud 3 +, -, G	11, 12, 9	Input 3	Output 3	Output 1
Aud 4 +, -, G	15, 14, 10	Input 4	Output 4	Output 2

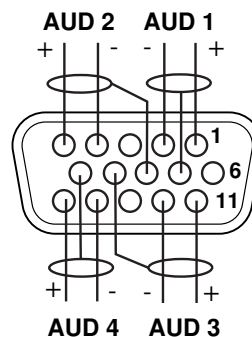

1 RU Backplane With 8415 Audio Submodule

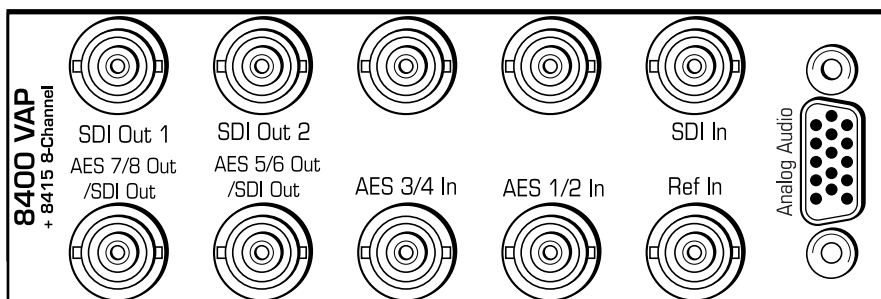

MODULE CONFIGURATION AND CONTROL

The configuration parameters for each Avenue module must be selected after installation. This can be done remotely using one of the Avenue remote control options or locally using the module front panel controls. Each module has a **REMOTE/LOCAL** switch on the front edge of the circuit board which must first be set to the desired control mode.

The configuration parameter choices for the module will differ between **Remote** and **Local** modes. In **Remote** mode, the choices are made through software and allow more selections. The **8400 Parameter Table** later in this section summarizes and compares the various configuration parameters that can be set remotely or locally and the default/factory settings. It also provides the default User Levels for each control. These levels can be changed using the Avenue PC application.

If you are not using a remote control option, the module parameters must be configured from the front panel switches. Parameters that have no front panel control will be set to a default value. The **Local** switches are illustrated in the **Front Panel Controls and Indicators** section following the **8400 Parameter Table**. The **Local** switches are inactive when the **Remote/Local** switch is in the **Remote** position.

In the **Remote** mode, Avenue module parameters can be configured and controlled from one or both of the remote control options, the Avenue Touch Screen or the Avenue PC Application. Once the module parameters have been set remotely, the information is stored on the module CPU. This allows the module to be moved to a different cell in the frame at your discretion without losing the stored information.

For setting the parameters remotely using the Avenue PC option, refer to the **Avenue PC Remote Configuration** section of this document.

For setting the parameters remotely using the Avenue Touch Screen option, refer to the **Avenue Touch Screen Remote Configuration** section of this document following Avenue PC.

Express Panel operation is described in the data pack that accompanies the control panel option.

Configuration Summary

This section provides a general overview of the configuration for the 8400 module. The controls available for configuration with remote control are summarized and tips and examples are given for using particular controls to achieve the best results.

Video Processing

The 8400 has a full-featured Proc Amp for adjustment of every signal parameter. Proc controls include Video and Chroma Gain, NTSC style hue rotation, Black Balance, and pedestal. Black and White clips can be set to prevent excessive signal excursions. To help optimize the settings in the Proc Amp, a Split Screen mode allows you to compare the processed output with the original material.

Certain values represented in serial digital component may be illegal in the NTSC or PAL composite domains. The Predictive Composite Clipper mode identifies picture elements that would be illegal in analog composite, and limits color saturation and luminance excursions. You can be confident that the work you're doing in digital component will look its best in composite.

A Detail Enhancer recovers information that has been lost due to poor frequency response in upstream systems. Selective (toothed) vertical blanking lets you choose to pass or strip content in the vertical interval on a line by line and field by field basis.

The 8400 has two SDI outputs. They are fully timed to your house reference.

The available video processing remote control menus are summarized below:

- **Proc Menu:** Gain, Chroma, Pedestal and Hue are standard Proc Amp controls. Even with SDI inputs and outputs, the Hue control gives phase rotation of the color vectors in the manner of an NTSC composite Proc Amp.
- **Clip:** The Legalizer is a predictive clipper which insures signal levels will not exceed those permitted in the composite domain. Thus its use can insure a television transmitter will not be presented illegal video input. If Off or Legal are selected other adjustments are grayed and may not be changed. While Legal automatically puts in values to insure signals will not exceed composite legal limits, selecting Custom allows the operator to insert a range of clip values.
- **Filters:** The Lum Sharp and Chr Sharp settings allow shaping of the passband for reduced or added sharpness. With both selections set to Off or Normal there is no modification of the video. Bandwidth reduction can be useful in reducing artifacts when using the 8400 for preprocessing of signals which will receive MPEG compression, while adding sharpness may benefit signals which arrive at the input with reduced bandwidth.
- **Timing:** The 8400's comprehensive range of timing allows complete flexibility in placement of the output picture relative to the applied reference input. Fine Phase and Hor Timing take the horizontal timing across the entire line with nanosecond accuracy. A Vert Timing adjustment completes the range in allowing any output timing desired by the operator.
- **Status:** This dynamic monitoring display provides indicators of video and audio inputs and EDH error status. Options such as the 8410, 8415, and 8510 Audio Processors and 8520 DNR show in the Option window when present.
- **Trims:** Cb and Cr offsets allow black balance to be corrected while Cb and Cr gains permit trimming of levels on these two axes. Y/C delay allows the operator to correct inaccuracy of timing of color information relative to luminance. These trims are functional regardless of the input or output formats in use.
- **Output:** The Bypass selection takes the 8400 Proc Amp out of the video path by routing the signal around it to the output. Split mode may be used to compare input and output signals to observe the effect of adjustments. Note that these are "live" modes and the bypassed or split video will be fed on downstream to following equipment. Embedded Audio is removed from the SDI stream when Strip is selected in the Strip Audio window.

- **Blanking:** There are Wide, Narrow or Custom blanking choices. Wide gives blanking through line 20 (NTSC) or line 22 (PAL), while narrow produces blanking through line 9 (NTSC) or Line 6 (PAL) of both fields. In the Custom mode any individual lines from 9 through 23 may be selectively blanked, with different choices allowed for each field. Some systems recognize position of the V-bit to control end of blanking. In the 525 standard V-bit position can be set to line 10, line 20 or line 23. In 625 mode V-bit is fixed at line 23 as this is the only position permitted by the 625 Standard.
- **Memory:** Up to five configurations of the 8400 may be saved into memory registers for later recall. All parameters – gains, input format, filters, blanking, etc. - are saved in each memory. The 8400 can be used with audio disembedding, channel swapping and re-embedding in a particular application. In another application it is used with noise reduction and embedding of audio from a digital audio input source. These two setups could be stored in memory registers and one or the other recalled for instant restoration of the required configuration.

8410, 8415, and 8510 Audio Processor Configuration

The 8510 Audio Processor will accept audio from analog or AES input connectors and can disembed audio from the incoming SDI video stream. The 8410 does everything the 8510 does, except that it has no analog audio I/O. The 8415 Audio Processor accepts audio from the AES input connectors and can disembed audio from the incoming SDI video stream.

Between the input and output is a 4x4 (or 8x8) audio mixer with tracking audio delay. Any incoming audio can be mixed, level controlled and/or shuffled to another output channel by means of the integrated audio router. The tracking audio delay allows synchronization and timing to be maintained with time base corrected video passing through the video frame synchronizer of the 8400.

A built in sample rate converter allows use of asynchronous AES input signals. The Audio Processors also support encoded audio formats such as AC-3 and Dolby-E. Because these data streams cannot tolerate sample rate conversion, they must be input to the Audio Processors synchronous to the video. All audio processing is performed at the full 24 bit resolution of the system. At the output side of the submodule the four (or eight) audio channels may be simultaneously routed to analog (8510 only) and AES output connectors while also being embedded on the outgoing SDI video. An adapter is also available to allow the AES I/O to be converted from BNC to 110 ohm balanced.

The available audio processing remote control menus are summarized below:

- **Audio In:** Status indicators show presence of AES and embedded (SDI) audio inputs. The In 1/2 Sel and In 3/4 Sel controls provide for selection of inputs to the 4x4 audio mixer. The choices for the 8410 and 8510 are AES 1/2, Anlg 1/2, SDI 1/2, AES 3/4, Anlg 3/4, and SDI 3/4. The 8415 has four additional choices, AES 5/6 and 7/8 and SDI 5/6 and 7/8. Thus any pair of input audio signals can be routed to either pair of input buses of the output audio mixer. As well (8510 only) the anticipated nominal level of this incoming audio can be set with the **Anlg Lvl** controls.
- **Audio Mode:** The Audio Mode control is provided to allow an SDI input with embedded audio to operate in Audio (normal) or Data (non-audio). The 8400 can handle both types of content present in AC-3 or Dolby_E signals. Some synchronizing requirements are necessary for supporting these protocols.

Select the **Audio** mode when the input audio signal is a standard audio signal carrying two channels of linear audio. No special timing requirements are needed in this mode.

Use the **Data** mode when the serial digital audio is a non-audio, or data, signal. Some special synchronizing requirements must be observed in this mode as described in the following examples.

SDI Signal with embedded data – For this case, if an SDI signal with embedded data is applied to the input, the content will be handled by passing through the 8400 frame store memory to the output of the 8400. No audio submodule is required. The audio input signal in this case is synchronous to the timing reference. This is normal operation of the 8400 and no special configuration is necessary.

Data mode signal to be disembedded and output as an AES stream – This mode requires the use of an audio submodule to disembed the de-serialized SDI input and route the channels to the correct path. If one of the channels is normal audio, it can be mixed, swapped, shuffled, and delayed by the audio submodule. If the other channel is non-audio data, it bypasses

the normal audio functions and is carried to the AES output formatter and driver.

When in the Data mode, the AES formatter is driven by the output timing of the 8400, the original SDI input must be synchronous to the reference input or the 8400 must be configured to use the SDI signal as the timing reference.

Data mode signal to be disembedded, output as AES, then re-embedded – In this case the audio submodule is also required. This case is similar to the one above, while the disembedded data is re-embedded in the SDI output of the 8400. The same timing requirements apply.

Original embedded data to be left unchanged with an additional embedded group to be added – The original embedding in the SDI input passes through the 8400 processing path. At the same time, an audio submodule is used to create a second embedded group which is placed in cascade, following the original audio group which contains the data mode signal.

A data mode signal in AES format is input to the audio submodule – This example could be used when there is a need to embed the AES data into the output of the 8400. In this case the AES data input must be synchronous. When being used in this manner, the audio submodule can embed data mode AES into one pair of channels in an embedded group, while embedding conventional audio into the other pair.

- **Audio Mix:** This menu gives full access to the 4x4 (or 8x8) audio mixer controls. Any input channel can be routed to any or all output busses. Sliders or Touch Screen rotary knobs permit levels to be adjusted from -70dB to +12dB. Alternatively a value can be put in the numeric window, followed by the Enter key, and this will become the new gain setting. Default buttons are provided for return to zero level.

The Tie function is used for stereo operation where gain of a pair of channels is usually desired to be the same. An invert selection allows inversion of a channel to permit phase correction.

- **Audio Delay:** With the Auto Track switched On, audio will be delayed the same amount as the video passing through the 8400 frame synchronizer thus preserving lip sync. If incoming audio is early due to signals passing through an upstream frame sync without a compensating audio delay, Bulk Delay can be used to correct the problem. Up to 1000 mS of fixed delay can be added to compensate for upstream timing errors.

Audio Operational Examples

This section describes the audio configuration of the application examples given at the beginning of this manual. Both the 8410 and 8510 have AES I/O and handle embedded audio. For analog audio, an 8510 is required.

Audio Example 1: Let's assume stereo analog audio is arriving from a satellite receiver (not AES, as shown in the Satellite block diagram). We want to embed this audio on an outgoing SDI video stream and also provide analog audio for monitoring. In addition we wish to provide audio for use in an audio console with AES inputs. Tracking audio delay will be used to maintain proper lip sync. We'll be using an 8400 with an 8510 submodule.

1. Bring the analog audio into channels 1 and 2. Refer to the connector drawing for pinout of the 15 pin D connector in the **Cabling** section.
2. With the In 1/2 Sel choose Anlg 1/2 as the source for channels 1 and 2 of the 4x4 audio mixer.
3. Set Anlg 1 Lvl and Anlg 2 Lvl to the nominal level of the incoming audio.
4. In the Audio Mix menu Select Ch1 for Output Bus 1 and Ch2 for Output Bus 2. The mixer output buses automatically appear on the designated output pins of the 15 pin D connector in analog form, and on the AES output BNC's as AES audio.
5. Select Embed On to embed the audio on to the SDI video output stream.
6. In the Aud Delay menu turn On the Auto Track so audio delay will track the video timing.

Audio Example 2: Consider a situation where there is embedded stereo audio on channels 1 and 2 of the incoming SDI video. A second language stereo feed comes in on AES channels 1 and 2 as shown in the Microwave block diagram but the level is 4 dB higher than desired.

1. SDI 1/2 is selected with the In 1/2 Sel so as to feed this audio to channels 1 and 2 of the 4x4 audio mixer.
2. AES 1/2 is selected with the In 3/4 Sel thus bringing the second audio information into channels 3 and 4 of the 4x4 audio mixer.
3. Tie is selected and the channel 3 and 4 faders set to -4dB to correct the incoming level discrepancy.
4. All 4 channels are then re-embedded on the outgoing SDI video by selecting Embed On.

These same 4 channels are also available as 4 analog outputs and AES output channels. It is now possible to monitor audio using the analog outputs from an 8510 while feeding the AES outputs to a digital audio mixer for further usage.

Audio Example 3: Here stereo audio embedded on an SDI stream is arriving via microwave, but lip sync is off by about 65mS due to video passing through upstream frame stores. We wish to synchronize to house reference and add monaural analog background music to the audio, then re-embed it back into the SDI video stream.

1. SDI 1/2 is selected with the In 1/2 Sel so as to feed the disembedded audio to channels 1 and 2 of the 4x4 audio mixer.
2. In the Audio Mix menu, select Ch1 for Output Bus 1 and Ch2 for Output Bus 2.
3. Anlg 3/4 is selected with the In 3/4 Sel. The monaural music is fed to channel 3 input with the channel 3 fader set to -10dB for proper background music level.
4. Channels 1 and 2 are selected for Output Bus assigns on this mixer so as to produce the desired background music mix for re-embedding.
5. A Bulk Delay of 65mS is used to correct for the upstream error.
6. Select Embed On to embed the audio on to the SDI video output stream.
7. Auto Track is set to the On state so the tracking audio delay will the match delay of the video frame synchronizer thus producing proper delay and correct lip sync.

8520 Digital Noise Reducer Configuration

The 8520 DNR is motion and scene adaptive. It removes unwanted noise and artifacts, making it perfect for MPEG compression preprocessing and satellite or ENG feeds.

Several forms of noise reduction are employed to ensure the best possible performance. Recursive Temporal Noise filtering includes Simple Recursive, Motion Adaptive and Motion Adaptive with Impulse filter. Controls are provided for maximum signal to noise improvement and for noise threshold. These can be set manually or run in automatic mode.

Motion Adaptive Recursive Noise filtering works on a pixel by pixel basis, comparing the current frame to frames that have already been filtered. If the change that is detected is small, it is considered noise, while if it is large, it is considered motion or a scene change. The detection process uses an LMMSE (Linear Minimum Mean Square Error) filtering algorithm to evaluate the presence of motion. Combining this algorithm with recursive temporal filters preserves fine detail while reducing noise in the presence of motion, including rapidly moving objects and scene changes. Motion trails are minimized while avoiding hard motion failures that some adaptive noise filters can exhibit.

The DNR menu gives six choices of operating mode:

1. **Automatic Lo:** A good setting for most material. Noise is reduced and the NR Factor and Threshold displays will be seen to change dynamically with video content. A moderate amount of noise is removed with few motion artifacts produced.
2. **Automatic Hi:** NR Factor and Threshold receive enhanced values for greater noise reduction with somewhat increased chance for motion artifacts to appear.
3. **Adaptive:** This manual setting allows the operator full control of all settings. A better mix of noise reduction vs motion artifacts is possible but, being a manual mode, it may not be possible for the operator to react optimally to changing scenes.
4. **Adaptive/Impulse 1:** Same as Adaptive with the addition of an impulse filter for removal of large, narrow amplitude noise pulses.
5. **Adaptive/Impulse 2:** Same as Adaptive with the addition of an impulse filter for removal of a wider bandwidth of noise. More softening of detail will be seen.
6. **Non Adaptive:** For still pictures, can be set for optimal noise reduction.

A special Luma Tie mode reduces dot crawl artifacts from composite originated material by identifying cross-color and cross-luminance effects as unwanted noise.

The Show Noise output mode displays what areas of the picture are being affected by the noise reducer. Noise is represented by white or black, while unaffected areas are represented in gray. This handy mode makes it easy to set optimum adjustments for the material being processed. The Split Screen mode lets you compare the processed output to the original signal.

8400 Parameter Table

CONTROL	LOCAL	REMOTE	DEFAULT/ FACTORY	DEFAULT USER LEVEL
VIDEO IN/PROCESSING CONTROLS				
Reference Source	Switch 4: TBC On (ext ref) or Off (self ref)	Ext Ref Master Ref Video In Ref	Ext Ref	Admin
Gain	100%	0 – 150%	100%	Admin
Chroma	100%	0 – 150%	100%	Admin
Pedestal	0 IRE	+/- 30 IRE	0 IRE	Admin
Hue	0 IRE	+/- 180 degrees	0 degrees	Admin
Legalizer	Switch 5: On or Off	Off Legal Custom	Off	Admin
B/W Clip	Off	Off On	Off	Admin
Black Clip	-8 IRE	-8 to 6.2 IRE	-8 IRE	Admin
White Clip	110 IRE	95 – 110 IRE	110 IRE	Admin
Chr CLip Mode	Off	Off Chroma Cpst	Off	Admin
Chr Lo Clip	-40 IRE	-40 to 7.5 IRE	-40 IRE	Admin
Chr Hi Clip	-40 IRE	100 – 140 IRE	140 IRE	Admin
DNR CONTROLS (8520 DNR submodule installed)				
DNR Mode	Switch 6: On (Automatic Lo) or Off	Automatic Lo Automatic Hi Adaptive Adapt/Impulse1 Adaptive/Impulse2 Non Adaptive	Automatic Lo	Admin
DNR Bypass	Normal	Normal Bypass Show Noise	Normal	Admin
DNR Luma	On	Off On Luma Tie	On	Admin
Luma NR Factor	6 dB	0 – 20 dB	6 dB	Admin
Luma Threshold	25 dB	0 – 25 dB	25 dB	Admin
DNR Chroma	Off	Off On	Off	Admin
Chroma NR Factor	6 dB	0 – 20 dB	6 dB	Admin
Chroma Threshold	25 dB	0 – 25 dB	25 dB	Admin

8400 Parameter Table (Continued)

CONTROL	LOCAL	REMOTE	DEFAULT/ FACTORY	DEFAULT USER LEVEL
FILTER CONTROLS				
Chr Sharp	Off	Max 1/2 1/4 Off	Off	Admin
Luma Sharp	Off	Max 1/2 1/4 Off	Off	Admin
TIMING CONTROLS				
Fine Phase	0 ns	+/- 40 ns	0 ns	Admin
Horizontal Timing	0 clocks	+/- 1716 clocks	0 clocks	Admin
Vertical Timing	0 lines	+/- 525 lines	0 lines	Admin
VIDEO OUTPUT CONTROLS				
Bypass	Normal	Normal Bypass Split Split DNR	Normal	Admin
Strip Audio	Off	Off On	Off	Admin
Color Lock	Normal	2 Field Normal Field 3 Field 5 Field 7	Normal	Admin
Setup	Off	Off On	Off	Admin
Test Pattern	Off	Off Bars Black Pathological	Off	Admin
Signal Mute	No Muting	No Muting Mutes on Noise Freeze On Noise	No Muting	Admin

8400 Parameter Table (Continued)

CONTROL	LOCAL	REMOTE	DEFAULT/ FACTORY	DEFAULT USER LEVEL
BLANKING and TRIM CONTROLS				
Mode	Narrow	Narrow (PAL Lines 1-6< NTSC Lines 1-9) Wide (PAL Lines 1-22< NTSC Lines 1-20) Custom	Wide	Admin
V Bit Position	Line 20	Line 10 Line 20 Line 23	Line 20	Admin
Field 1/2 Toothed Blanking	N/A	< 9, 9, 10, 11, 12, 13, 14, 15, 16, 17, 18, 19, 20, 21, 22, 23		Level 2
Cb Offset	0 IRE	+/- 300 IRE	0 IRE	Admin
Cr Offset	0 IRE	+/- 300 IRE	0 IRE	Admin
Cb Gain	0 IRE	+/- 20 IRE	0 IRE	Admin
Cr Gain	0 IRE	+/- 20 IRE	0 IRE	Admin
AUDIO CONTROLS (8410, 8415 or 8510 Audio Submodule Installed)				
Ch 1-4 In (level)	-70 dB	-70 to +12 dB	-70 dB	Level 1
Ch 1-4 Output Bus	Ch 1 – Output 1 Ch 2 – Output 2 Ch 3 – Output 3 Ch 4 – Output 4	Output Bus 1 – 4	Ch 1 – Output 1 Ch 2 – Output 2 Ch 3 – Output 3 Ch 4 – Output 4 Tie	Level 1
1/2 Input	Switch 7: Anlg or Dig If Dig: Switch 8: AES or Embed	AES 1/2 Anlg 1/2 (8510) SDI 1/2 AES 3/4 Anlg 3/4 SDI 3/4	Anlg 1/2	Level 1
3/4 Input		AES 1/2 Anlg 1/2 (8510) SDI 1/2 AES 3/4 Anlg 3/4 SDI 3/4	Anlg 3/4	Level 1
5/6 and 7/8 Input (8415 only)	N/A	AES 1/2 AES 3/4 AES 5/6 AES 7/8 SDI 1/2 SDI 3/4 SDI5/6 SDI 7/8		Level 1

8400 Parameter Table (Continued)

CONTROL	LOCAL	REMOTE	DEFAULT/ FACTORY	DEFAULT USER LEVEL
1/2, 3/4, 5/6, 7/8 Mode	Auto	Audio Data Auto	Auto	Level 1
DeMux Group	Group 1	Group 1 Group 2 Group 3 Group 4	Group 1	Level 1
Anlg In Level (8510 only)	+4 dB	-10 dB -6 dB -4 dB 0 dB +4 dB	+4 dB	Level 1
Auto Track	On	Off On	On	Level 1
Bulk Delay	0 msec	0 – 1000 msec	0 msec	Level 1
Audio Embed	Replace	Off Replace Cascade Replace All (8415, Embed A))	Replace	Level 1
Mux Group (Mux Group A and B for the 8415)	Group 1	Group 1 Group 2 Group 3 Group 4	Group 1	Level 1
Anlg Out Level (8510 only)	+4 dB	-10 dB -6 dB -4 dB 0 dB +4 dB	+4 dB	Level 1
Dig Ref Level	-20 dBFS	-20 dBFS -18 dBFS	-20 dBFS	Level 1

Front Panel Controls and Indicators

Each front edge indicator and switch setting is shown in the diagram below:

Input green LED:

On indicates input video signal is present and detected.
OFF no input video signal detected on the input.

Embed audio green LED:

On when an audio ancillary packet is detected in the serial stream. **OFF** when no audio ancillary packet is detected.

AES In 1/2 green LED:

On when an AES input is detected on the AES 1/2 audio input.
OFF when no audio is detected on AES 1/2.

AES 3/4 green LED:

On when an AES input is detected on the AES 3/4 audio input.
OFF when no AES audio is detected on AES 3/4.

Remote/Local switch:

Set to the mode you will be using.

Run green LED:

OFF:
 A power fault or halted CPU
ON:
 A halted CPU
FAST BLINK:
 CPU Run error
SLOW BLINK:
 System OK. (If SPI control is active from the main frame System Control Module, all **Run** indicators will be synchronized.)

Pwr green LED:

Indicates the presence (**ON**) or absence (**OFF**) of power (+5V).

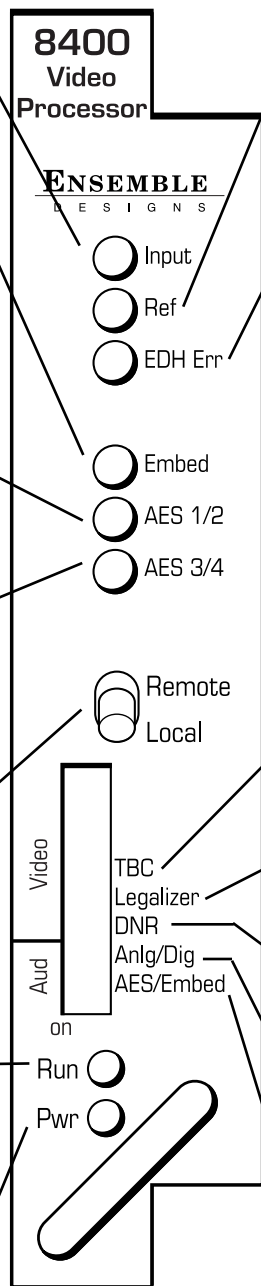

Ref green LED:

On when the selected reference source is detected.
OFF when no reference signal is detected.

EDH Err red LED:

On when EDH is present and CRC errors are detected.
OFF when EDH is not present or CRC errors are not detected.

TBC switch:

Turn time base corrector (external reference) **On** or **Off**.

Legalizer switch:

Turn **On** to enable legalizer or **OFF** to disable.

DNR switch:

Select **On** to enable DNR processing or **Off** to disable the DNR.

Anlg/Dig switch:

When the 8510 is installed, select **Anlg** or **Dig** to identify what audio format is being input to the module.

AES/Embed switch:

When switch above is set to **Dig**, select **AES** or **Embed** to identify what type of digital audio is being input to the module.

Avenue PC Remote Configuration

The Avenue PC remote control menus for this module are illustrated and explained below. Refer to the **8400 Parameter Table** for a summary of available parameters that can be set remotely through the menus illustrated. The **Configuration Summary** gives tips and general background information on setting the parameters. For more information on using Avenue PC, refer to the Avenue PC Control Application Software data pack.

Parameter fields that are grayed out can indicate one of the following conditions:

- An option is not installed.
- The function is not active.
- The module is locked.
- The User Level set with Avenue PC is not accessible from the current User Level.

NOTE: Different audio menus will appear when an 8415 Audio Processor submodule is installed. The differences in menu structure will be explained in this section.

8400 Avenue PC Menus

The **Vid In** menu shown below allows you to configure the following input source:

- **Ref Source** – use this control to set the reference input source.

Status reporting is provided for the following conditions:

- **Input** – reports the input status as **No Input**, **525 Lock**, or **625 Lock**.
- **EDH Status** – reports the presence of EDH, EDA, and IDA errors.
- **Error Seconds** – displays the number of seconds that a detected EDH error has been present in the serial data stream.
- **Reference** – reports the status of the reference input as either **No Reference**, **Ref Mismatch**, **Ref Unlocked**, **Ref 525 Lock**, or **Ref 625 Lock**.

Timing		Blanking		Vid Out		Memory		Trim	
Vid In	Proc	Clip	DNR	Aud Mix	Aud In	Aud Delay	Aud Out	Filter	
Input				EDH Error					
525 Lock				No Error					
				Error Seconds					
				0 Cnt					
Ref Source				Reference					
Master Ref				Ref 525 Lock					

Model 8400 Series Modules

The **Proc** menu shown below allows you to adjust the following video processing parameters for the signal. For numerical choices, use the slider control to select a value or enter a value into the number field at right and press the **Enter** key on your PC.

- **Gain** – adjust the percentage of overall gain (luminance and chrominance).
- **Chroma** – adjust the percentage of chroma amplitude.
- **Pedestal** – adjust the pedestal (black) level of the signal in IRE.
- **Hue** – adjust the hue of the signal ± 180 degrees.

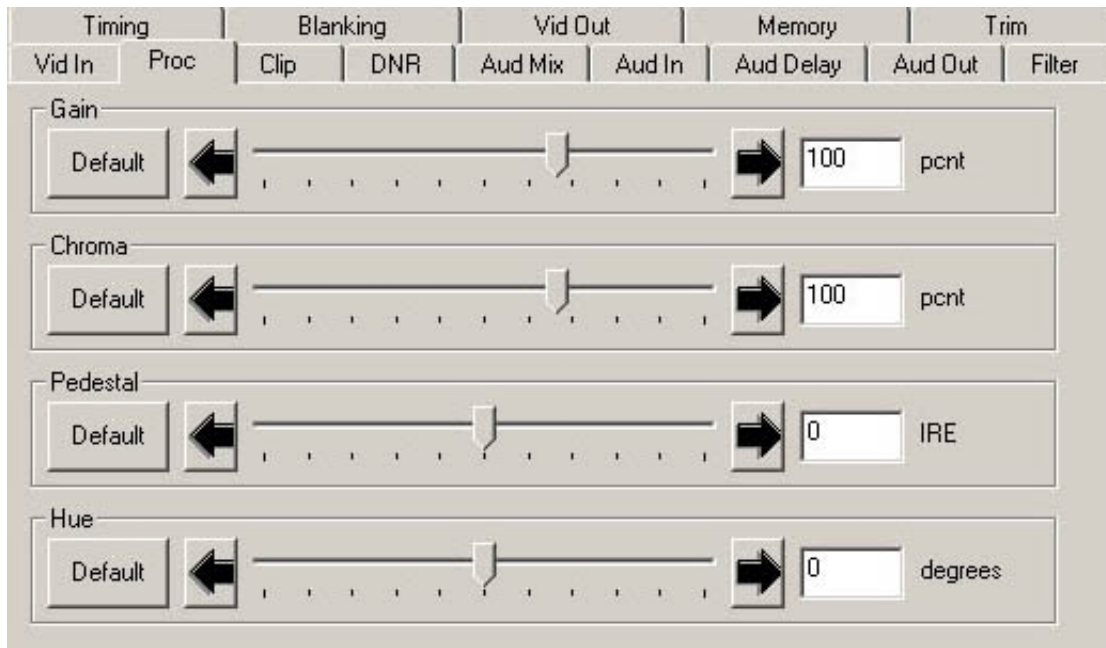

Use the **Clip** menu shown below to adjust the following parameters:

- **Legalizer** – set the legalizer function to one of the following:

Off – to disable it.

Legal – to apply the following factory default values:

- **B/W Clip** is on.
- **Black Clip** is set to 2.5 IRE.
- **White Clip** is set to +105 IRE.
- **Chr Clip Mode** is predictive composite.
- **Chr Lo Clip** is set to –20 IRE.
- **Chr Hi Clip** is set to +120 IRE.

Custom – to enable the **B/W Clip** and **Chr Clip Modes** controls to set custom parameters with the following controls:

- **B/W Clip** – select On to enable black and white clip functions or Off to disable them.
 - **Black Clip** – set the threshold for the black clip level. (No content will be allowed below the level set.)
 - **White Clip** – set the threshold for the white clip. (No content will be allowed above the level set.)
- **Chr Clip Mode** – select one of the following modes:
 - **Off** for no chroma clip functions.
 - **Chroma** to use the chroma clip controls **Chr Lo Clip/Chr Hi Clip** to set to clip the chroma content (irrespective of the luminance).
 - **Cpst** to enable the Predictive Composite Clipper. This mode allows you to ensure that when the signal is encoded to PAL or NTSC, the minimum and maximum chroma excursions do not exceed preset levels. Because in composite video, the chroma rides on the luminance, this clip mode is based on chroma and luminance values.

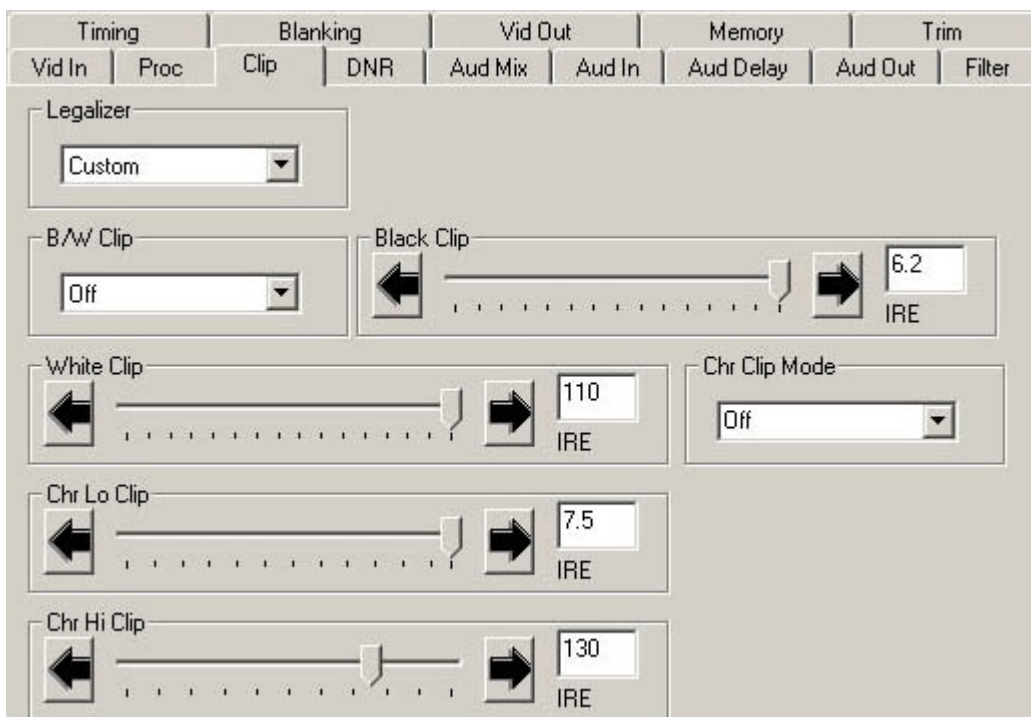

The **DNR** menu allows you to adjust the following noise reducer parameters for the signal when the 8520 DNR submodule is installed:

- **Mode** – set the mode of noise reduction based on the type of noise and the amount of motion in the signal. Set the **Mode** to one of the following:

Automatic Lo – this setting is completely automatic and requires no user adjustments. The adjustments for Noise Reduction (NR) and Threshold change depending on the source material. Luma and Chroma filters and Chroma/Luma tie controls are shown in the figure below. This mode uses the Impulse 1 filter that removes a moderate amount of noise and shows little motion artifacts. It is most useful for signals that vary a great deal and require less operator intervention.

Automatic Hi – this setting is also completely automatic and requires no user adjustments. The adjustments for enhanced noise reduction (NR) and Threshold. Luma and Chroma filters and Chroma/Luma tie are on. This mode uses the Impulse 2 filter (also temporal). All noise is removed in this mode and chances are higher for motion artifacts to appear.

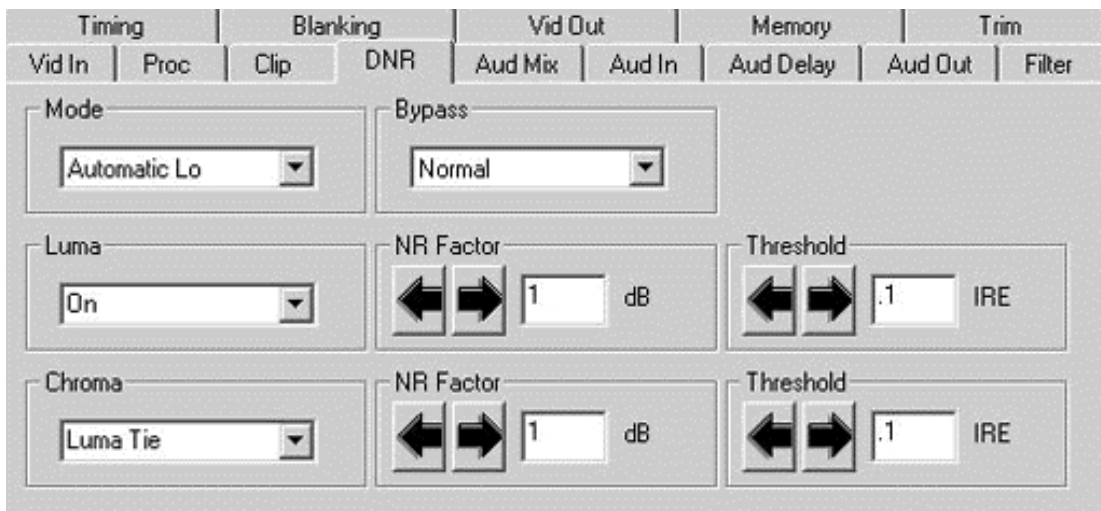

Adaptive – this mode requires manual settings of all parameters. Fine detail is preserved and motion is removed. Best used for signals with less motion and results viewed with the Show Noise function and a waveform monitor. The Adaptive controls are shown in the figure below.

Adapt/Impulse 1 – this mode is similar to the Adaptive mode above but adds an Impulse 1 filter control for removal of impulse noise — large, narrow amplitude noise with a very high bandwidth (narrow). This filter requires detail to be very fine before it will be removed. It is best for removing fine sparkles in the video. Some fine moving details, such as rain, can soften and blur with this filter enabled and so is not recommended for this type of scene.

Adapt/Impulse 2 – this mode is similar to the Adaptive/Impulse 1 mode above but adds an Impulse 2 filter control. This allows removal of a wider bandwidth of impulse noise. As a result, scenes with bigger detail will be affected. This is also an effective filter for removing sparkles but blurring and softening of detail will be more obvious than the Impulse 1 filter.

Non Adaptive – this filter is the most effective for still pictures. Noise reduction can be set to the highest level with the luma and chroma NR and threshold controls to produce the best results. Not recommended for pictures with any motion.

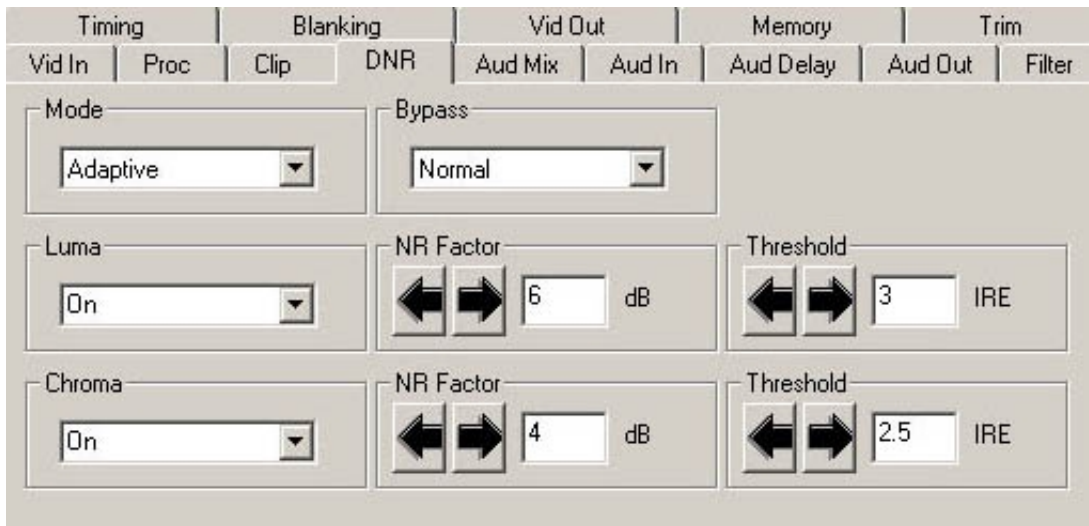

- **Luma** – set to **On** to enable the Luma control or **Off** to disable. The luma channel can be adjusted independently of the chroma channel for noise reduction and motion threshold while in any of the Motion Adaptive Recursive modes.
 - Use the Luma **NR Factor** and **Threshold** controls to fine tune the noise as it appears on a waveform monitor and the **Show Noise** function set in the Bypass mode below.
- **Chroma** – set to **On** to enable the Luma control or **Off** to disable. The noise reduction and threshold of the chroma channel can be adjusted independently of the luma channel with these controls. A Luma Tie setting is provided that controls the chroma filter based on the motion estimation on the luma channel. Not only is noise more effectively reduced when this control is active, but it can also reduce the appearance of cross-color artifacts from poor upstream decoding of composite signals.
 - Use the Chroma **NR Factor** and **Threshold** controls to fine tune the chroma noise factor.
- **Bypass** – set the DNR output mode in conjunction with the **Vid Out** menu Bypass function with this control. You may use this control to view the desired DNR output for comparing noise reduction or detail enhancement. Refer to the **Vid Out** menu for details on setting this mode.

8410 and 8510 Audio Processor Submodules

When an 8410 or 8510 Audio Processor submodule is installed, use the **Aud Mix** menu shown below to control the audio mixing and shuffling of the module. Each output bus assignment will be indicated by a green box.

- **Input Ch 1** – assign Input Channel 1 to the desired output bus or tie to Channel 2. Set the input level using the slider control or by entering a number in the window and pressing the **Enter** key on your PC.
- **Input Ch 2** – assign Input Channel 2 to the desired output bus or tie to Channel 1. Set the input level using the slider control or by entering a number in the window and pressing the **Enter** key on your PC.
- **Input Ch 3** – assign Input Channel 3 to the desired output bus or tie to Channel 4. Set the input level using the slider control or by entering a number in the window and pressing the **Enter** key on your PC.
- **Input Ch 4** – assign Input Channel 4 to the desired output bus or tie to Channel 3. Set the input level using the slider control or by entering a number in the window and pressing the **Enter** key on your PC.

Selecting the **Tie** button in Input Ch 1 or Input Ch 2 will tie the two controls together. Selecting the **Tie** button in Input Ch 3 or Input Ch 4 will tie the controls for these channels together.

Select the **Default** button to return to the default value.

Select the **Invert** button to invert the phase of the audio content.

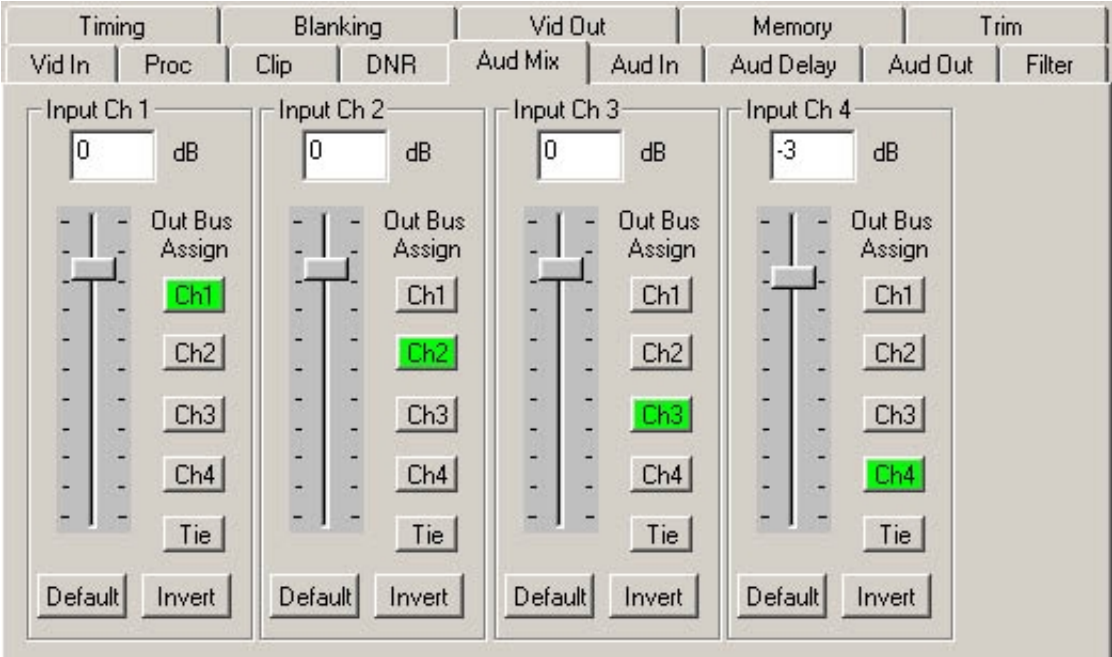

Use the **Aud In** menu shown below for the 8410 and 8510 to adjust the following parameters:

- **1/2 Input** – select the input audio source for Input 1/2.
- **3/4 Input** – select the input audio source for Input 3/4.
- **1/2 Mode** – for a Serial input with embedded audio, select the type of audio in the stream:
 - **Audio** – the embedded stream is standard audio.
 - **Data** – the embedded stream is a non-audio signal.
 - **Auto** – the module will detect the type of signal embedded in the stream, audio or data.
- **3/4 Mode** – select the type of audio in the serial stream as described above.
- **DeMux Group** – select the embedded audio group to demultiplex from the selections. The status of embedded audio is shown in the **Embed In** view.
- **Anlg In Lvl** (8510 only)– set the nominal level of the analog audio input.

Setting analog levels: For example, if the nominal level of your incoming analog audio is +4 dB, set the **Anlg In Lvl** to **+4 dB** (8510 only).

The status of the corresponding audio inputs are shown next to the control. Status is reported as one of the following:

- **Analog In** (8510 only) – analog video is present on the input.
- **No Input** – no serial digital embedded audio is detected.
- **Audio Sync** – the audio embedded in the stream is synchronous with the timing reference.
- **Data Sync** – the data embedded in the stream is synchronous with the timing reference.
- **Audio Async** – the audio embedded in the stream is non-synchronous with the timing reference.



8415 Audio Processor Submodule

When an 8415 Audio Processor submodule is installed, use the **Aud Mix A** and **B** menus shown to control the audio mixing and shuffling of the module. Each output bus assignment will be indicated by a green box.

For Channels 1 –4, use the **Audio Mix A** menu to set the following

- **Input Ch 1** – assign Input Channel 1 to the desired output bus or tie to Channel 2. Set the input level using the slider control or by entering a number in the window and pressing the **Enter** key on your PC.
- **Input Ch 2** – assign Input Channel 2 to the desired output bus or tie to Channel 1. Set the input level using the slider control or by entering a number in the window and pressing the **Enter** key on your PC.
- **Input Ch 3** – assign Input Channel 3 to the desired output bus or tie to Channel 4. Set the input level using the slider control or by entering a number in the window and pressing the **Enter** key on your PC.
- **Input Ch 4** – assign Input Channel 4 to the desired output bus or tie to Channel 3. Set the input level using the slider control or by entering a number in the window and pressing the **Enter** key on your PC.

Selecting the **Tie** button in Input Ch 1 or Input Ch 2 will tie the two controls together. Selecting the **Tie** button in Input Ch 3 or Input Ch 4 will tie the controls for these channels together.

Select the **Default** button to return to the default value.

Select the **Invert** button to invert the phase of the audio content.

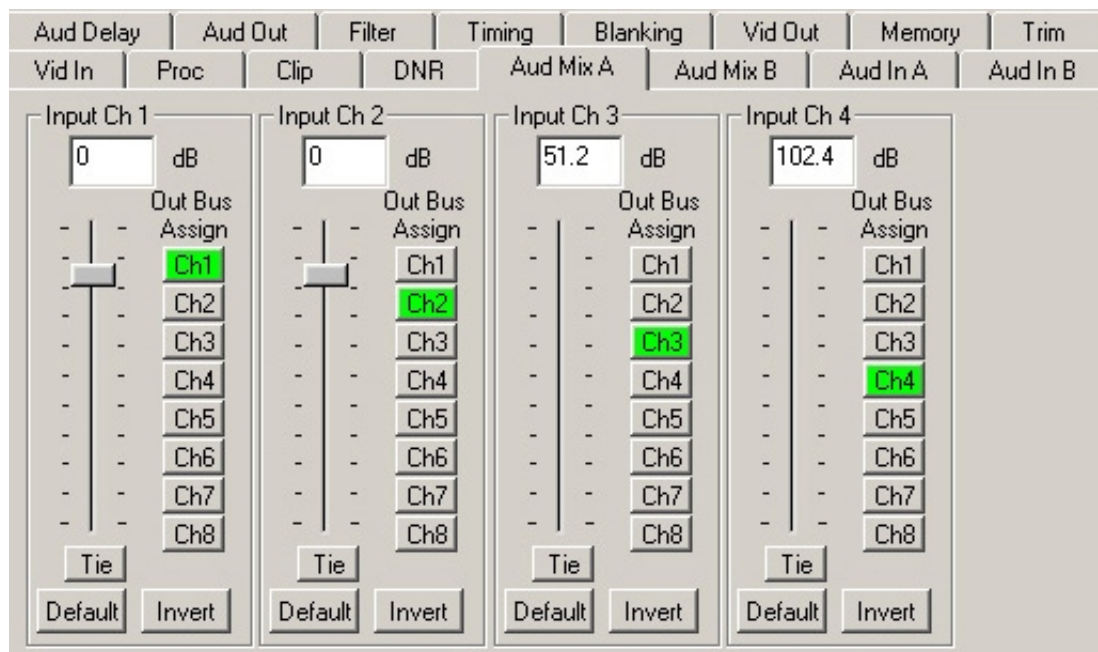

For Channels 5 –8, use the **Audio Mix B** menu shown below to set the following

- **Input Ch 5** – assign Input Channel 5 to the desired output bus or tie to Channel 6. Set the input level using the slider control or by entering a number in the window and pressing the **Enter** key on your PC.
- **Input Ch 6** – assign Input Channel 6 to the desired output bus or tie to Channel 5. Set the input level using the slider control or by entering a number in the window and pressing the **Enter** key on your PC.
- **Input Ch 7** – assign Input Channel 7 to the desired output bus or tie to Channel 8. Set the input level using the slider control or by entering a number in the window and pressing the **Enter** key on your PC.
- **Input Ch 8** – assign Input Channel 8 to the desired output bus or tie to Channel 7. Set the input level using the slider control or by entering a number in the window and pressing the **Enter** key on your PC.

Selecting the **Tie** button in Input Ch 5 or Input Ch 6 will tie the two controls together. Selecting the **Tie** button in Input Ch 7 or Input Ch 8 will tie the controls for these channels together.

Select the **Default** button to return to the default value.

Select the **Invert** button to invert the phase of the audio content.

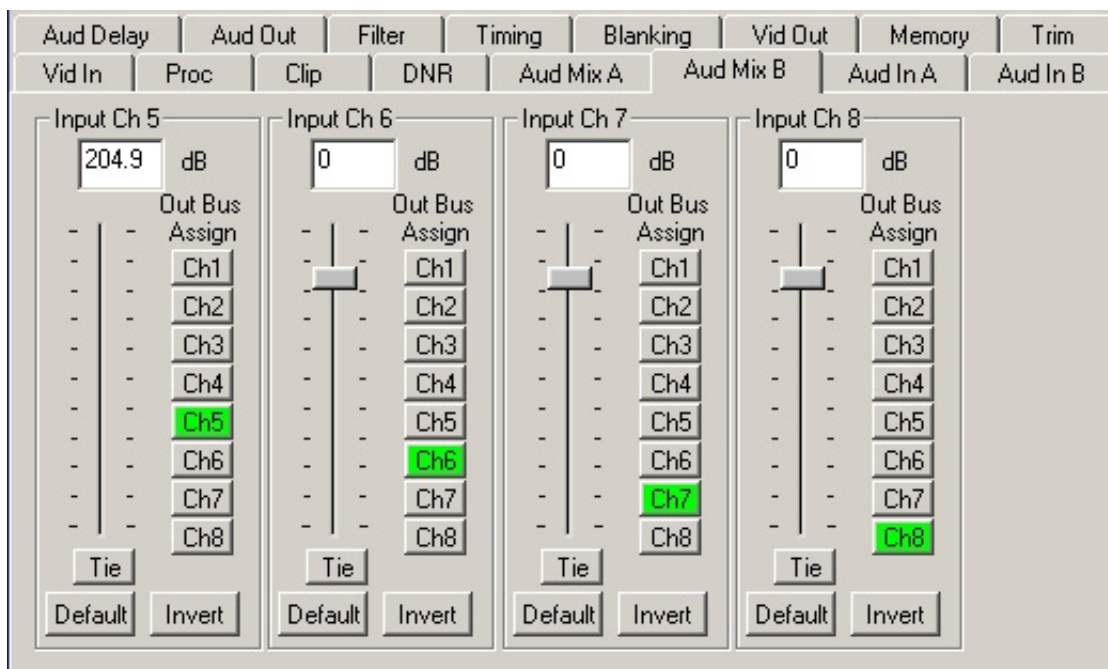

Use the **Aud In A** menu shown below for the 8415 to adjust the following parameters:

- **1/2 Input** – select the input audio source for Input 1/2.
- **3/4 Input** – select the input audio source for Input 3/4.

When an AES input pair is selected as an input, the corresponding AES BNC on the rear of the module will become an input. If an AES input is not selected, the corresponding BNC on the rear of the module will automatically become an output. Refer to the block diagram on page 4 for an illustration of the input/output BNCs.

- **1/2 Mode** – for a Serial input with embedded audio, select the type of audio in the stream:
 - **Audio** – the embedded stream is standard audio.
 - **Data** – the embedded stream is a non-audio signal.
 - **Auto** – the module will detect the type of signal embedded in the stream, audio or data.
- **3/4 Mode** – select the type of audio in the serial stream as described above.
- **DeMux Group** – select the embedded audio group to demultiplex from the selections. The status of embedded audio is shown in the **Embed In** view.

The status of the corresponding audio inputs are shown next to the control. Status is reported as one of the following:

- **No Input** – no serial digital embedded audio is detected.
- **Audio Sync** – the audio embedded in the stream is synchronous with the timing reference.
- **Data Sync** – the data embedded in the stream is synchronous with the timing reference.
- **Audio Async** – the audio embedded in the stream is non-synchronous with the timing reference.

Aud Delay	Aud Out	Filter	Timing	Blanking	Vid Out	Memory	Trim
Vid In	Proc	Clip	DNR	Aud Mix A	Aud Mix B	Aud In A	Aud In B
1/2 Input AES 1/2		1/2 Status No Input		1/2 Mode Audio			
3/4 Input AES 3/4		3/4 Status No Input		3/4 Mode Audio			
DeMux Group Group 1		Embed In A None					

Use the **Aud In B** menu shown below for the 8415 to adjust the following parameters:

- **5/6 Input** – select the input audio source for Input 5/6.
- **7/8 Input** – select the input audio source for Input 7/8.

When an AES input pair is selected as an input, the corresponding AES BNC on the rear of the module will become an input. If an AES input is not selected, the corresponding BNC on the rear of the module will automatically become an output. Refer to the block diagram on page 4 for an illustration of the input/output BNCs.

- **5/6 Mode** – for a Serial input with embedded audio, select the type of audio in the stream:
 - **Audio** – the embedded stream is standard audio.
 - **Data** – the embedded stream is a non-audio signal.
 - **Auto** – the module will detect the type of signal embedded in the stream, audio or data.
- **7/8 Mode** – select the type of audio in the serial stream as described above.
- **DeMux Group** – select the embedded audio group to demultiplex from the selections. The status of embedded audio is shown in the **Embed In** view.

The status of the corresponding audio inputs are shown next to the control. Status is reported as one of the following:

- **No Input** – no serial digital embedded audio is detected.
- **Audio Sync** – the audio embedded in the stream is synchronous with the timing reference.
- **Data Sync** – the data embedded in the stream is synchronous with the timing reference.
- **Audio Async** – the audio embedded in the stream is non-synchronous with the timing reference.

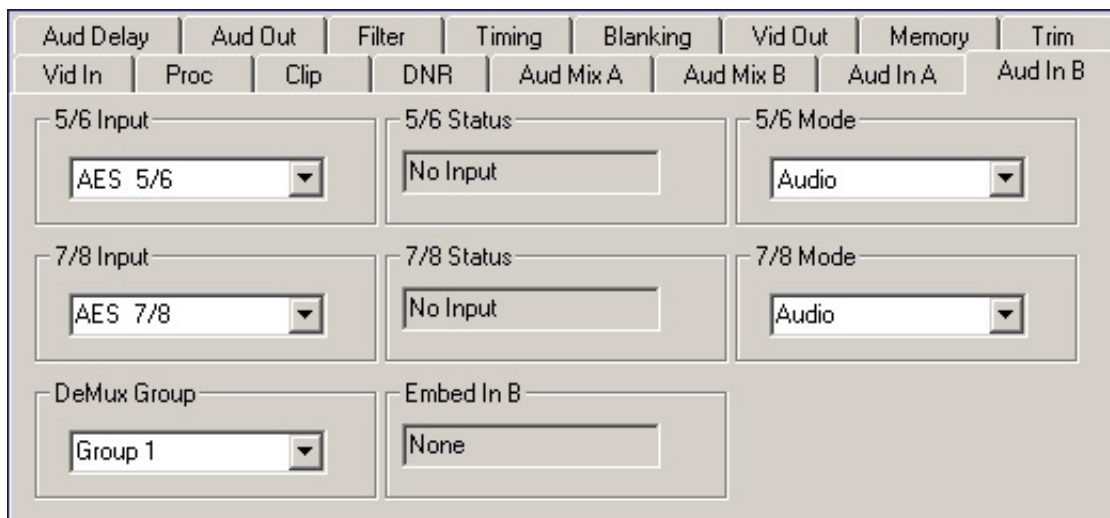

Use the **Aud Delay** menu shown below for all versions of Audio submodule to adjust the amount of audio delay on the output:

- **Auto Track** – enable auto tracking by selecting **On** or **Off**.
- **Bulk Delay** – set the amount of bulk delay using the left and right arrows or enter a value in the **msec** field and press the **Enter** key on your PC..

The amount of total delay will be reported in nsec in the **Total Delay** window.



8410 and 8510: Use the **Aud Out** menu shown below to adjust the following audio output parameters:

- **Audio Embed** – turn embedding **Off** for no embedding in the output signal. To embed an audio group, select the position to embed from either **Cascade** (next available audio group) or **Replace** (replace all groups).
- **Mux Group** – select the multiplexed group to be embedded in the output.
- **Anlg Lvl Out** (only for 8510) – set the output level of the analog audio.
- **Dig Ref Level** – set the digital reference level for the audio output.



8415: Use the **Aud Out** menu shown below to adjust the following audio output parameters:

- **Audio Embed A** – turn embedding **Off** for no embedding to take place in the output signal. Select **Replace** to replace the targeted group in the stream with new content. If there is no such group already present, the new content will be placed in the horizontal interval in normal cascade, following any other content already there. When **Cascade** is selected, the audio channels are placed after any existing content. **Replace All** will strip all of the original content and the new content is placed at the beginning of the horizontal interval.
- **Audio Embed B** – identical to **Audio Embed A** but no **Replace All** function is required as this will occur upstream in the A embedder..
- **Mux Group A** – select the multiplexed group to be embedded in embedder A in the output.
- **Mux Group B** – select the multiplexed group to be embedded in embedder B in the output.
- **Dig Ref Level** – set the digital reference level for the audio output.

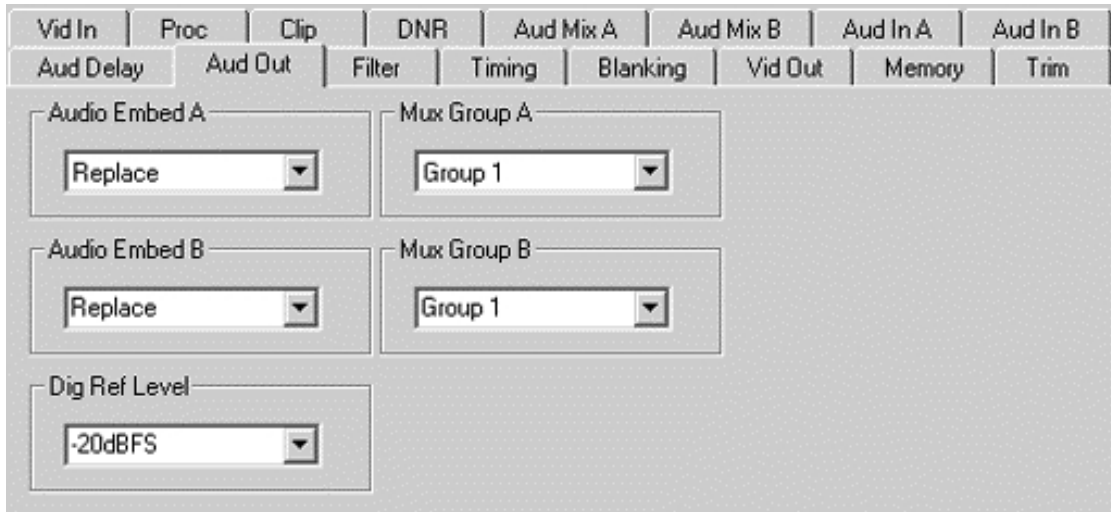

The **Filter** menu shown below allows setting of the luminance and chroma sharpness (with DNR option) with the following detail enhancing controls:

- **Lum Sharp** – set to **Off** to bypass detail enhancing filters. Set to **1/4**, **1/2**, or **Max** to set the sharpness of the luminance portion of the signal.
- **Chr Sharp** – set to **Off** to bypass detail enhancing filters. Set to **1/2**, **1/4**, or **Max** to set the sharpness of the chrominance portion of the signal.

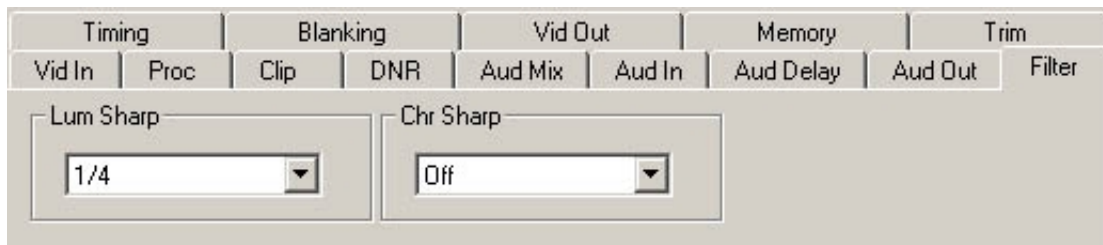

Use the **Timing** menu shown below to adjust the following parameters. For numerical choices, use the slider control to select a value or enter a value into the number field at right and press the **Enter** key on your PC.

- **Hor Timing** – adjust the horizontal timing of the output signal to place the leading edge of sync coincident with other sources.
- **Vertical Timing** – set the vertical timing to a typical setting of 0 lines.

This menu provides a **Delay** window at the bottom of the screen that will report the total delay in lines of the module.

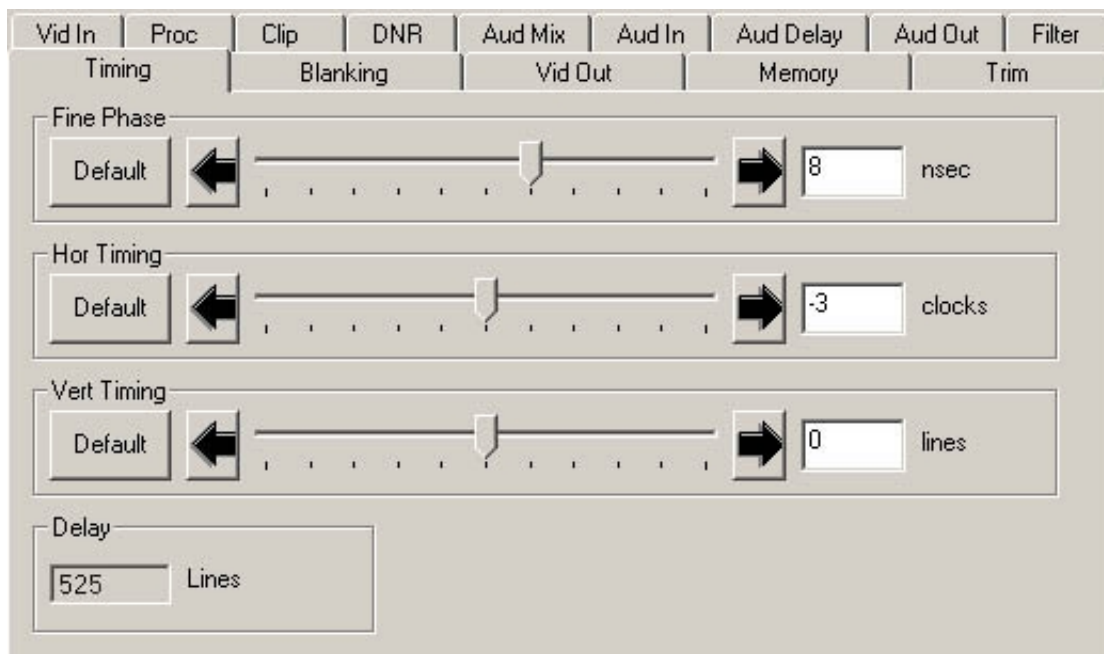

The **Blanking** menu shown below allows you to adjust the output blanking of the module with the following controls:

- **Mode** – set the blanking mode to **Narrow** (lines 1-9 are blanked in NTSC, lines 1-6 in PAL), **Wide** (lines 1-20 in NTSC, lines 1-22 in PAL), or **Custom**.

In **Custom** mode you may select which lines are blanked on a line by line basis in Field 1 and Field 2. A green box indicates the line is blanked. In NTSC, there are individual blanking controls for each line starting with 10 ending with 21. In PAL, there are blanking controls for lines 7 and 8 as one group (both passed or both blank) and individual blanking controls for each line starting with 9 ending with 23.

- **V Bit Pos** – in 525 mode only. Set the position of the vertical bit in the SDI output to **Line 10**, **Line 20**, or **Line 23**.

The screenshot shows a software interface for video processing. At the top, there are several tabs: Vid In, Proc, Clip, DNR, Aud Mix, Aud In, Aud Delay, Aud Out, and Filter. Below these, there are sub-tabs: Timing, Blanking, Vid Out, Memory, and Trim. The Blanking menu is active and contains the following controls:

- Mode:** A dropdown menu set to "Custom".
- V Bit Pos:** A dropdown menu set to "Line 20".
- Field 1:** A grid of 16 buttons representing lines 9 through 23. Lines 10, 11, 12, 13, 14, 15, 16, 17, 18, 19, and 20 are highlighted with a green background, indicating they are blanked. Lines 9, 21, 22, and 23 are not highlighted.
- Field 2:** A grid of 16 buttons representing lines 9 through 23. Lines 9, 10, 11, 12, 13, 14, 15, 16, 17, 18, 19, 20, 21, 22, and 23 are not highlighted, indicating they are not blanked.

Use the **Vid Out** menu shown below to adjust the following parameters:

- **Bypass** – set to **Normal** for no split screen, **Bypass** to completely bypass any digital processing, or **Split or Split DNR** to enable a split screen comparison between the original input signal (left) and the processed output (right). Use this control in conjunction with the **Bypass** control in the **DNR** menu as described in the summary table on the following page.
- **Strip Audio** – select the box to strip embedded audio from the output. Leave the box unselected to pass embedded audio through to the output.
- **Test Pattern** – select a test pattern to be sent to the video output of the module.
- **Signal Mute** – set to one of the following three choices:
 - 1) **No Muting** – allows the video to pass through regardless of video quality.
 - 2) **Mutes on Noise** – when the module detects the video quality to be unacceptable, the 8400 will output a black signal.
 - 3) **Freeze on Noise** – when the module detects the video quality to be unacceptable, the 8400 will freeze and output the last good field of video.

Vid In	Proc	Clip	DNR	Aud Mix	Aud In	Aud Delay	Aud Out	Filter
Timing		Blanking		Vid Out		Memory		Trim
Bypass				Strip Audio				
Normal				<input type="checkbox"/> Strip				
Test Pattern				Signal Mute				
Off				Mutes on Noise				

Output and DNR Menu Bypass Mode Table

Output Menu Bypass Setting	DNR Menu Bypass Setting	Output Conditions
Normal	Normal	All processing on.
	Bypass	All DNR processing is off.
	Show Noise	DNR processing is on. Show noise function is full screen with all DNR controls operative.
Bypass	Any setting	All processing is bypassed.
Split	Normal	Left side of screen unprocessed, right side of screen processed with Proc Amp and DNR. All controls active for DNR.
	Bypass	Left side of screen unprocessed, right side of screen processed without DNR.
	Show Noise	Left side of screen unprocessed, right side of screen processed showing noise removed by DNR. All controls active.
Split DNR	Normal	Left side of screen processed without DNR, right side of screen processed with DNR. All controls active.
	Bypass	Left side of screen processed without DNR, right side of screen processed without DNR.
	Show Noise	Left side of screen processed without DNR, right side of screen processed showing noise removed by DNR. All controls active.

The **Memory** menu shown below allows you to save overall module setups to five memory registers as follows:

- Select **Save**, then one of the five memory registers **Reg 1 – 5**. The box will turn green. The entire module setup is now saved in the selected register.
- To recall a register, select the register box. If there is information saved, the box will turn green. The saved setup will now be loaded to the module. Up to five different module setups can be saved and recalled using the individual registers.

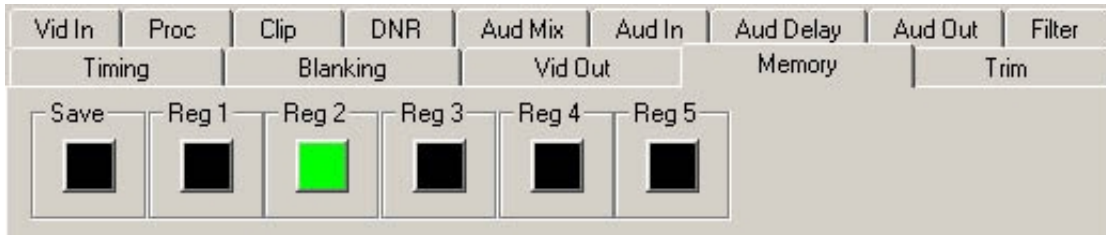

The **Trim** menu allows you to correct subtle issues in the individual color difference channels with offset and gain controls. The offset controls adjust the DC offsets above or below the nominal points. This can be used to correct black balance errors. The gain controls adjust the amplitude of each channel. It is helpful to set the output of the module to **Split Screen** (in the **Vid Out** menu) to allow viewing a comparison of the processed signal to the input while adjusting the controls below.

Use the controls described below to make the offset and gain corrections. For numerical choices, use the slider control to select a value or enter a value into the number field at right and press the **Enter** key on your PC.

- **Cb Offset** – adjust the DC offset of the Cb channel to between ± 300 IRE.
- **Cr Offset** – adjust the DC offset of the Cr channel to between ± 300 IRE.
- **Cb Gain** – adjust the amplitude of the Cb channel to between ± 20 IRE.
- **Cr Gain** – adjust the amplitude of the Cr channel to between ± 20 IRE.

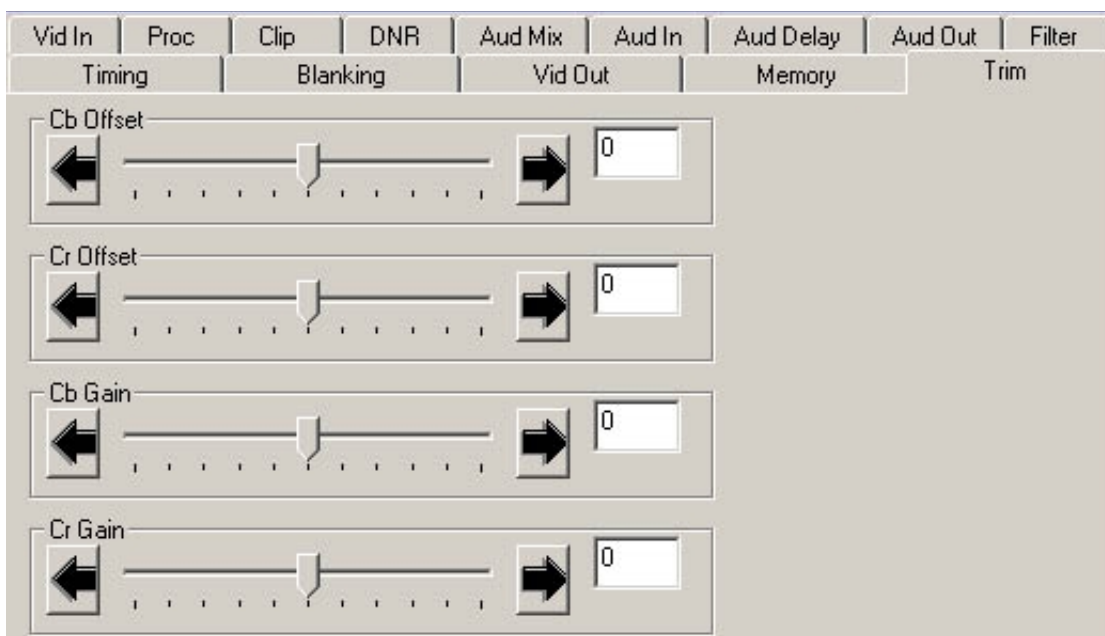

Avenue Touch Screen Remote Configuration

The Avenue Touch Screen remote control status menu for this module is illustrated and explained below. Refer to the **8400 Parameter Table** for a summary of available parameters that can be set remotely through the menus illustrated. The **Configuration Summary** gives tips and general background information on setting the parameters. For more information on using Avenue Touch Screen, refer to the Avenue System Overview.

Parameter fields that are grayed out can indicate one of the following conditions:

- An option is not installed.
- The function is not active.
- The module is locked.
- The User Level set with Avenue PC is not accessible from the current User Level.

NOTE: Different audio menus will appear when an 8415 Audio Processor submodule is installed. The differences in menu structure will be explained in this section.

8400 Avenue Touch Screen Menus

The **Vid In** menu shown below allows you to configure the following input sources:

- **Ref Source** – use this control to set the reference input source.

Status reporting is provided for the following conditions:

- **Input** – reports the input status as **No Input**, **525 Lock**, or **625 Lock**.
- **EDH Status** – reports the presence of EDH, EDA, and IDA errors.
- **Error Seconds** – displays the number of seconds that a detected EDH error has been present in the serial data stream.
- **Reference** – reports the status of the reference input as either **No Reference**, **Ref Mismatch**, **Ref Unlocked**, **Ref 525 Lock**, or **Ref 625 Lock**.

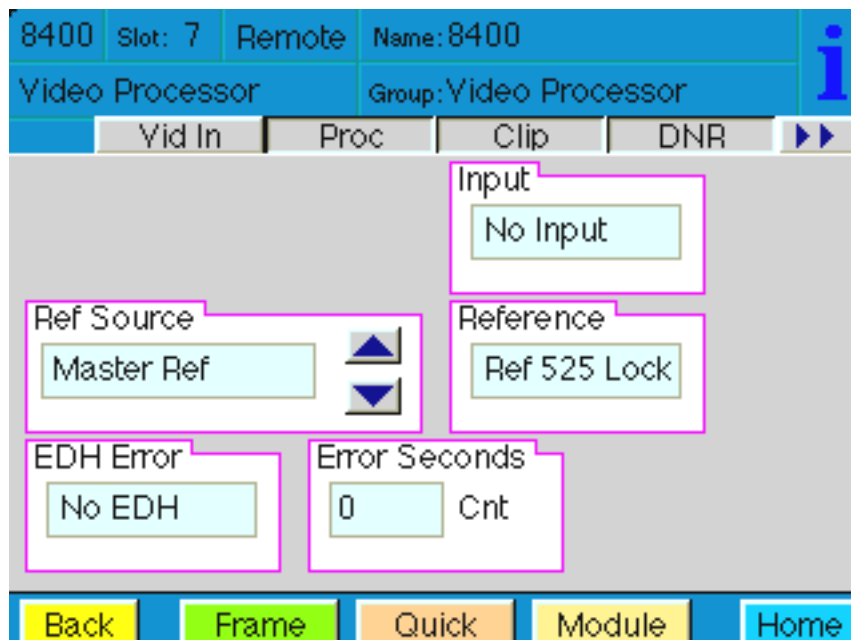

The **Proc** menu shown below allows you to adjust the following video processing parameters for the signal. For numerical choices, use the slider control to select a value or enter a value into the number field at right and press the **Enter** key on your PC.

- **Gain** – adjust the percentage of overall gain (luminance and chrominance).
- **Chroma** – adjust the percentage of chroma amplitude.
- **Pedestal** – adjust the pedestal (black) level of the signal in IRE.
- **Hue** – adjust the hue of the signal ± 180 degrees.

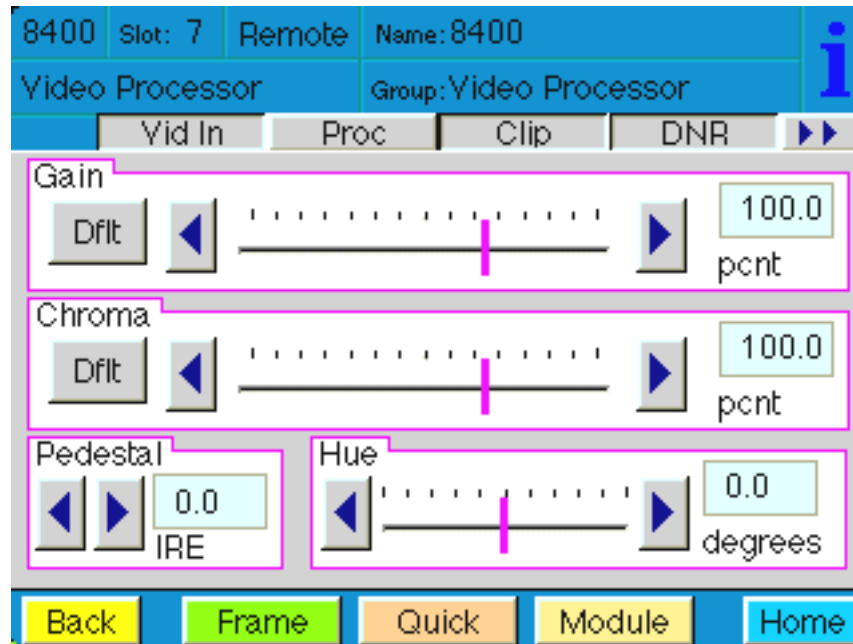

Use the **Clip** menu shown below to adjust the following parameters:

- **Legalizer** – set the legalizer function to one of the following:

Off – to disable it.

Legal – to apply the following factory default values:

- **B/W Clip** is on.
- **Black Clip** is set to 2.5 IRE.
- **White Clip** is set to +105 IRE.
- **Chr Clip Mode** is predictive composite.
- **Chr Lo Clip** is set to -20 IRE.
- **Chr Hi Clip** is set to +120 IRE.

Custom – to enable the **B/W Clip** and **Chr Clip Modes** controls to set custom parameters with the following controls:

- **B/W Clip** – select On to enable black and white clip functions or Off to disable them.
 - **Black Clip** – set the threshold for the black clip level. (No content will be allowed below the level set.)
 - **White Clip** – set the threshold for the white clip. (No content will be allowed above the level set.)
- **Chr Clip Mode** – select one of the following modes:
 - **Off** for no chroma clip functions.
 - **Chroma** to use the chroma clip controls **Chr Lo Clip/Chr Hi Clip** to set to clip the chroma content (irrespective of the luminance).
 - **Cpst** to enable the Predictive Composite Clipper. This mode allows you to ensure that when the signal is encoded to PAL or NTSC, the minimum and maximum chroma excursions do not exceed preset levels. Because in composite video, the chroma rides on the luminance, this clip mode is based on chroma and luminance values.

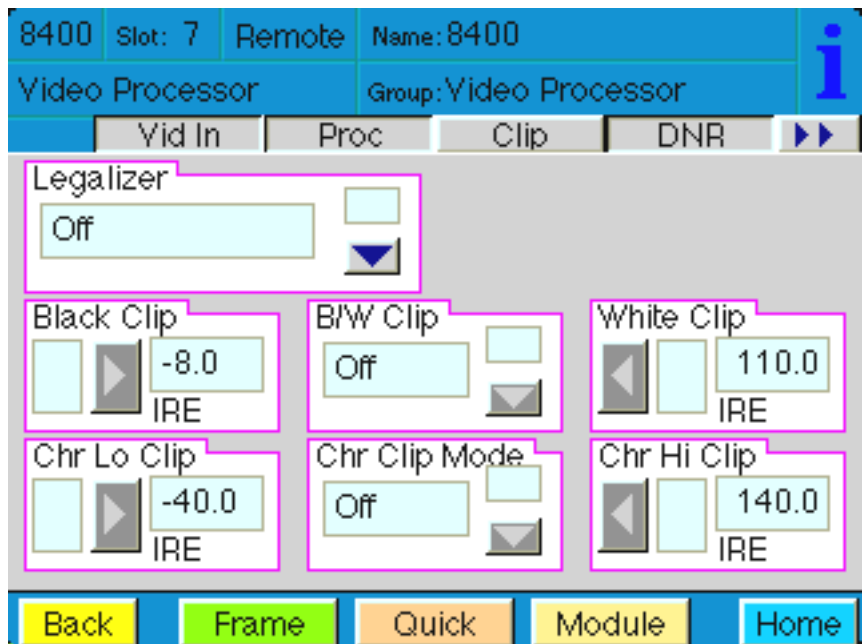

The **DNR** menu allows you to adjust the following noise reducer parameters for the signal when the 8520 DNR submodule is installed:

- **Mode** – set the mode of noise reduction based on the type of noise and the amount of motion in the signal. Set the **Mode** to one of the following:

Automatic Lo – this setting is completely automatic and requires no user adjustments. The adjustments for Noise Reduction (NR) and Threshold change depending on the source material. Luma and Chroma filters and Chroma/Luma tie controls are shown in the figure below. This mode uses the Impulse 1 filter that removes a moderate amount of noise and shows little motion artifacts. It is most useful for signals that vary a great deal and require less operator intervention.

Automatic Hi – this setting is also completely automatic and requires no user adjustments. The adjustments for enhanced noise reduction (NR) and Threshold. Luma and Chroma filters and Chroma/Luma tie are on. This mode uses the Impulse 2 filter (also temporal). All noise is removed in this mode and chances are higher for motion artifacts to appear.

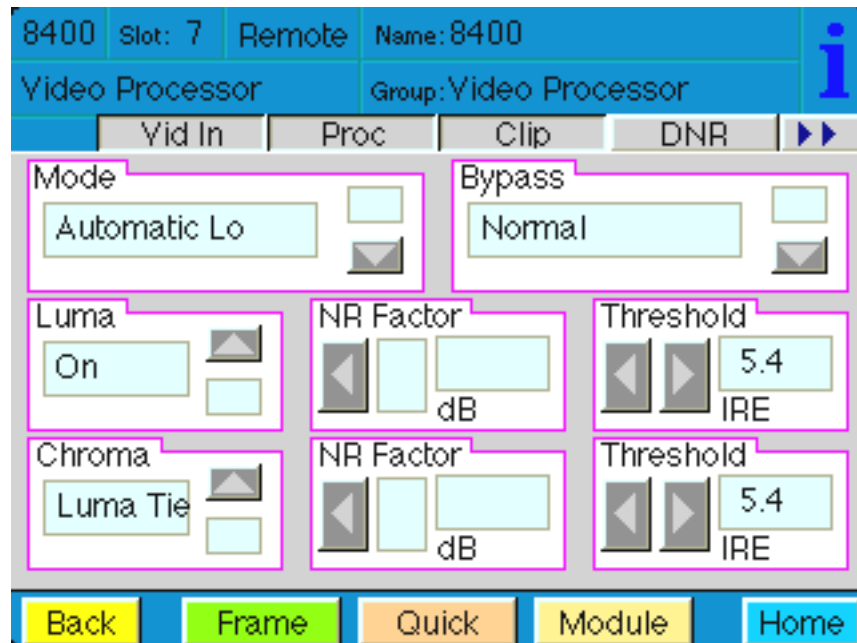

Adaptive – this mode requires manual settings of all parameters. Fine detail is preserved and motion is removed. Best used for signals with less motion and results viewed with the Show Noise function and a waveform monitor. The Adaptive controls are shown in the figure below.

Adapt/Impulse 1 – this mode is similar to the Adaptive mode above but adds an Impulse 1 filter control for removal of impulse noise — large, narrow amplitude noise with a very high bandwidth (narrow). This filter requires detail to be very fine before it will be removed. It is best for removing fine sparkles in the video. Some fine moving details, such as rain, can soften and blur with this filter enabled and so is not recommended for this type of scene.

Adapt/Impulse 2 – this mode is similar to the Adaptive/Impulse 1 mode above but adds an Impulse 2 filter control. This allows removal of a wider bandwidth of impulse noise. As a result, scenes with bigger detail will be affected. This is also an effective filter for removing sparkles but blurring and softening of detail will be more obvious than the Impulse 1 filter.

Non Adaptive – this filter is the most effective for still pictures. Noise reduction can be set to the highest level with the luma and chroma NR and threshold controls to produce the best results. Not recommended for pictures with any motion.

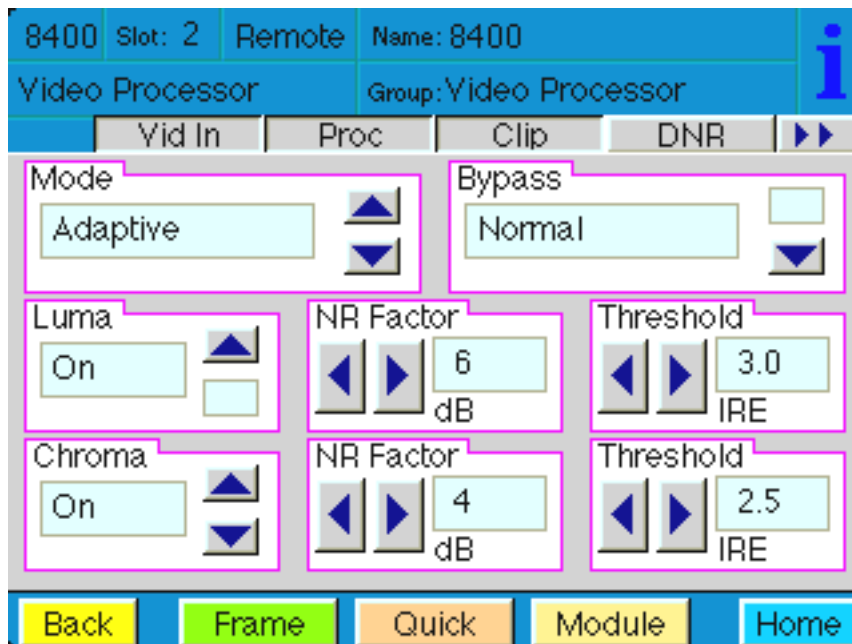

- **Luma** – set to **On** to enable the Luma control or **Off** to disable. The luma channel can be adjusted independently of the chroma channel for noise reduction and motion threshold while in any of the Motion Adaptive Recursive modes.
 - Use the Luma **NR Factor** and **Threshold** controls to fine tune the noise as it appears on a waveform monitor and the **Show Noise** function set in the Bypass mode below.
- **Chroma** – set to **On** to enable the Luma control or **Off** to disable. The noise reduction and threshold of the chroma channel can be adjusted independently of the luma channel with these controls. A Luma Tie setting is provided that controls the chroma filter based on the motion estimation on the luma channel. Not only is noise more effectively reduced when this control is active, but it can also reduce the appearance of cross-color artifacts from poor upstream decoding of composite signals.
 - Use the Chroma **NR Factor** and **Threshold** controls to fine tune the chroma noise factor.
- **Bypass** – set the DNR output mode in conjunction with the **Vid Out** menu Bypass function with this control. You may use this control to view the desired DNR output for comparing noise reduction or detail enhancement. Refer to the **Vid Out** menu for details on setting this mode.

8410 and 8510 Audio Processor Submodules

When an 8410 or 8510 Audio Processor submodule is installed, use the **Aud Mix** menu shown below to control the audio mixing and shuffling of the module. Each output bus assignment will be indicated by a green box.

- **Input Ch 1** – assign Input Channel 1 to the desired output bus or tie to Channel 2. Set the input level using the slider control or by entering a number in the pop-up window and press the **Enter** key.
- **Input Ch 2** – assign Input Channel 2 to the desired output bus or tie to Channel 1. Set the input level using the slider control or by entering a number in the pop-up window and press the **Enter** key.
- **Input Ch 3** – assign Input Channel 3 to the desired output bus or tie to Channel 4. Set the input level using the slider control or by entering a number in the pop-up window and press the **Enter** key.
- **Input Ch 4** – assign Input Channel 4 to the desired output bus or tie to Channel 3. Set the input level using the slider control or by entering a number in the pop-up window and press the **Enter** key.

Selecting the **Tie** button in Input Ch 1 or Input Ch 2 will tie the two controls together. Selecting the **Tie** button in Input Ch 3 or Input Ch 4 will tie the controls for these channels together.

Select the **Default** button to return to the default value.

Select the **Invert** button to invert the phase of the audio content.

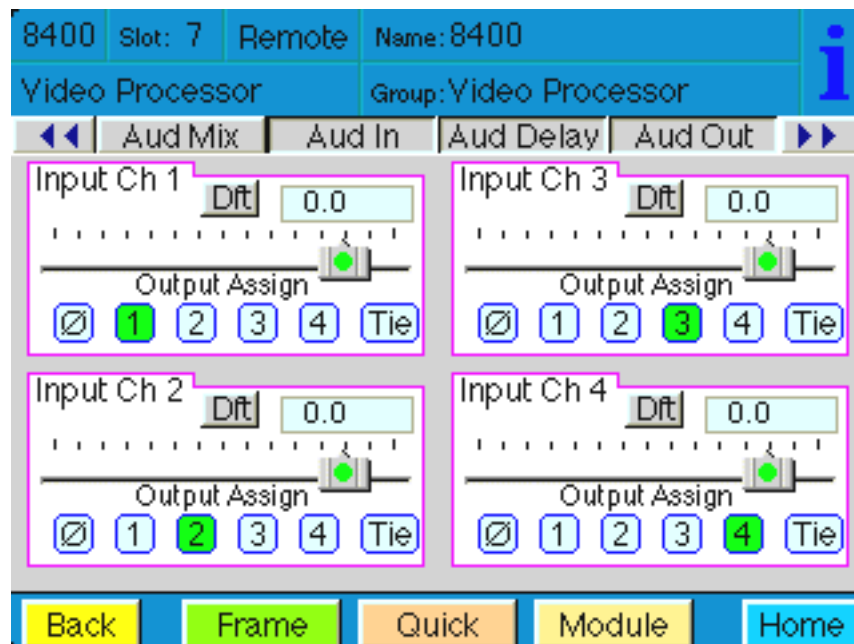

Use the **Aud In** menu shown below for the 8410 and 8510 to adjust the following parameters:

- **1/2 Input** – select the input audio source for Input 1/2.
- **3/4 Input** – select the input audio source for Input 3/4.
- **1/2 Mode** – for a Serial input with embedded audio, select the type of audio in the stream:
 - **Audio** – the embedded stream is standard audio.
 - **Data** – the embedded stream is a non-audio signal.
 - **Auto** – the module will detect the type of signal embedded in the stream, audio or data.
- **3/4 Mode** – select the type of audio in the serial stream as described above.
- **DeMux Group** – select the embedded audio group to demultiplex from the selections. The status of embedded audio is shown in the **Embed In** view.
- **Anlg In Lvl** (8510 only)– set the nominal level of the analog audio input.

Setting analog levels: For example, if the nominal level of your incoming analog audio is +4 dB, set the **Anlg In Lvl** to **+4 dB** (8510 only).

The status of the corresponding audio inputs are shown next to the control. Status is reported as one of the following:

- **Analog In** (8510 only) – analog video is present on the input.
- **No Input** – no serial digital embedded audio is detected.
- **Audio Sync** – the audio embedded in the stream is synchronous with the timing reference.
- **Data Sync** – the data embedded in the stream is synchronous with the timing reference.
- **Audio Async** – the audio embedded in the stream is non-synchronous with the timing reference.

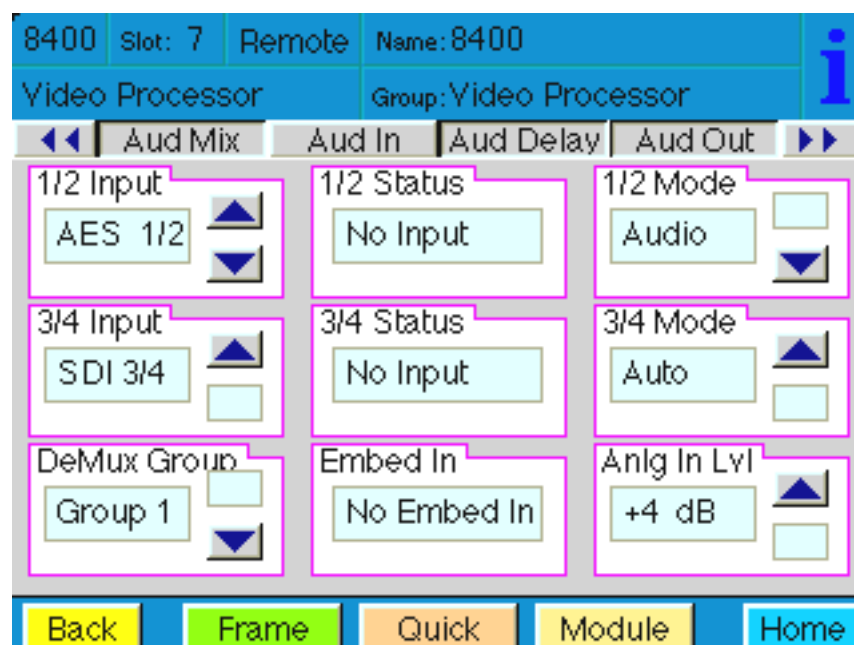

8415 Audio Processor Submodule

When an 8415 Audio Processor submodule is installed, use the **Aud Mix** menus shown on the next page to control the audio mixing and shuffling of the module. Each output bus assignment will be indicated by a green box.

For Channels 1 –4, use the **Audio Mix A** menu to set the following

- **Input Ch 1** – assign Input Channel 1 to the desired output bus or tie to Channel 2. Set the input level using the slider control or by entering a number in the pop-up window and press the **Enter** key.
- **Input Ch 2** – assign Input Channel 2 to the desired output bus or tie to Channel 1. Set the input level using the slider control or by entering a number in the pop-up window and press the **Enter** key.
- **Input Ch 3** – assign Input Channel 3 to the desired output bus or tie to Channel 4. Set the input level using the slider control or by entering a number in the pop-up window and press the **Enter** key.
- **Input Ch 4** – assign Input Channel 4 to the desired output bus or tie to Channel 3. Set the input level using the slider control or by entering a number in the pop-up window and press the **Enter** key.

Selecting the **Tie** button in Input Ch 1 or Input Ch 2 will tie the two controls together. Selecting the **Tie** button in Input Ch 3 or Input Ch 4 will tie the controls for these channels together.

Select the **Default** button to return to the default value.

Select the **Ø** button to invert the phase of the audio content.

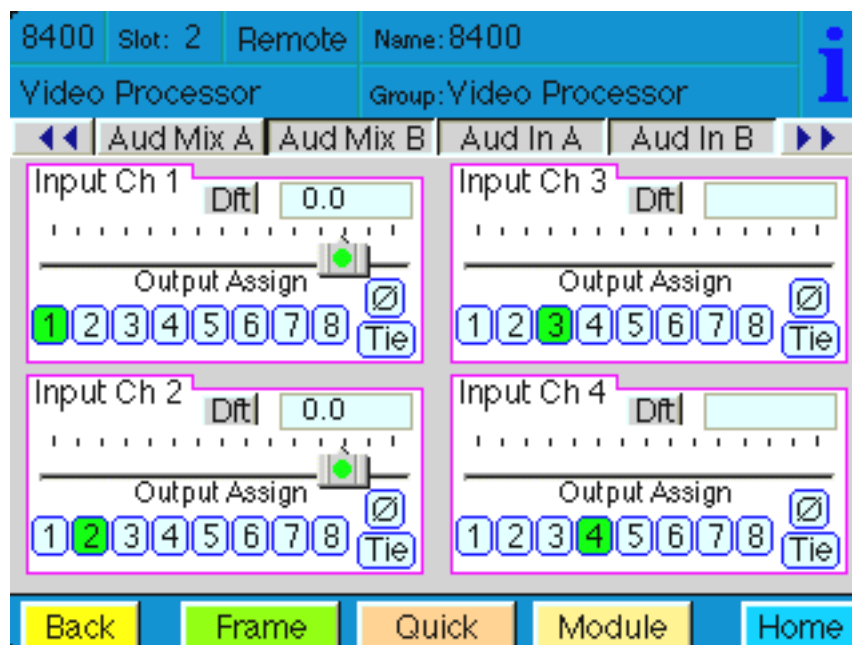

For Channels 5 –8, use the **Audio Mix B** menu shown below to set the following

- **Input Ch 5** – assign Input Channel 5 to the desired output bus or tie to Channel 6. Set the input level using the slider control or by entering a number in the pop-up window and press the **Enter** key.
- **Input Ch 6** – assign Input Channel 6 to the desired output bus or tie to Channel 5. Set the input level using the slider control or by entering a number in the pop-up window and press the **Enter** key.
- **Input Ch 7** – assign Input Channel 7 to the desired output bus or tie to Channel 8. Set the input level using the slider control or by entering a number in the pop-up window and press the **Enter** key.
- **Input Ch 8** – assign Input Channel 8 to the desired output bus or tie to Channel 7. Set the input level using the slider control or by entering a number in the pop-up window and press the **Enter** key.

Selecting the **Tie** button in Input Ch 5 or Input Ch 6 will tie the two controls together. Selecting the **Tie** button in Input Ch 7 or Input Ch 8 will tie the controls for these channels together.

Select the **Default** button to return to the default value.

Select the **Ø** button to invert the phase of the audio content.

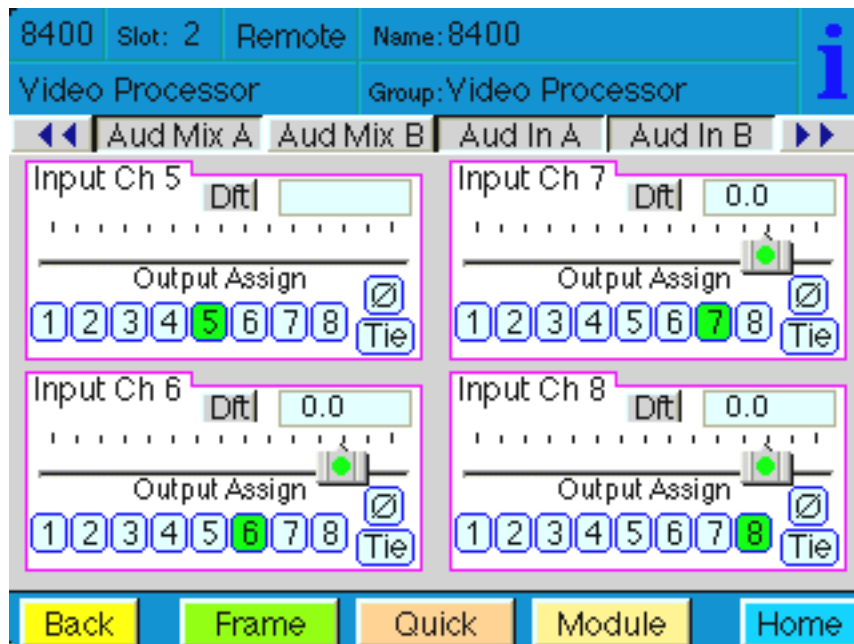

Use the **Aud In A** menu shown below for the 8415 to adjust the following parameters:

- **1/2 Input** – select the input audio source for Input 1/2.
- **3/4 Input** – select the input audio source for Input 3/4.

When an AES input pair is selected as an input, the corresponding AES BNC on the rear of the module will become an input. If an AES input is not selected, the corresponding BNC on the rear of the module will automatically become an output. Refer to the block diagram on page 4 for an illustration of the input/output BNCs.

- **1/2 Mode** – for a Serial input with embedded audio, select the type of audio in the stream:
 - **Audio** – the embedded stream is standard audio.
 - **Data** – the embedded stream is a non-audio signal.
 - **Auto** – the module will detect the type of signal embedded in the stream, audio or data.
- **3/4 Mode** – select the type of audio in the serial stream as described above.
- **DeMux Group** – select the embedded audio group to demultiplex from the selections. The status of embedded audio is shown in the **Embed In** view.

The status of the corresponding audio inputs are shown next to the control. Status is reported as one of the following:

- **No Input** – no serial digital embedded audio is detected.
- **Audio Sync** – the audio embedded in the stream is synchronous with the timing reference.
- **Data Sync** – the data embedded in the stream is synchronous with the timing reference.
- **Audio Async** – the audio embedded in the stream is non-synchronous with the timing reference.

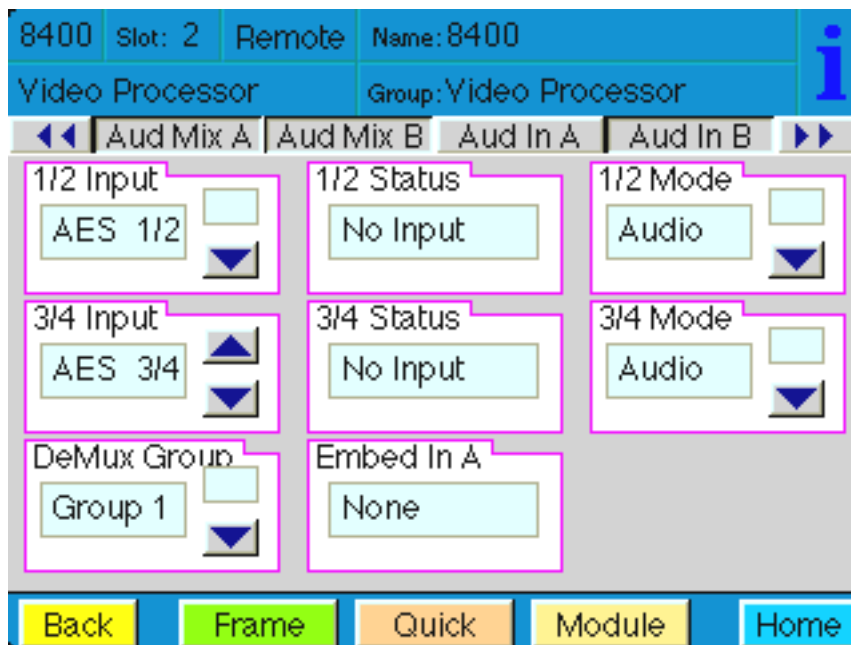

Use the **Aud In B** menu shown below for the 8415 to adjust the following parameters:

- **5/6 Input** – select the input audio source for Input 5/6.
- **7/8 Input** – select the input audio source for Input 7/8.

When an AES input pair is selected as an input, the corresponding AES BNC on the rear of the module will become an input. If an AES input is not selected, the corresponding BNC on the rear of the module will automatically become an output. Refer to the block diagram on page 4 for an illustration of the input/output BNCs.

- **5/6 Mode** – for a Serial input with embedded audio, select the type of audio in the stream:
 - **Audio** – the embedded stream is standard audio.
 - **Data** – the embedded stream is a non-audio signal.
 - **Auto** – the module will detect the type of signal embedded in the stream, audio or data.
- **7/8 Mode** – select the type of audio in the serial stream as described above.
- **DeMux Group** – select the embedded audio group to demultiplex from the selections. The status of embedded audio is shown in the **Embed In** view.

The status of the corresponding audio inputs are shown next to the control. Status is reported as one of the following:

- **No Input** – no serial digital embedded audio is detected.
- **Audio Sync** – the audio embedded in the stream is synchronous with the timing reference.
- **Data Sync** – the data embedded in the stream is synchronous with the timing reference.
- **Audio Async** – the audio embedded in the stream is non-synchronous with the timing reference.

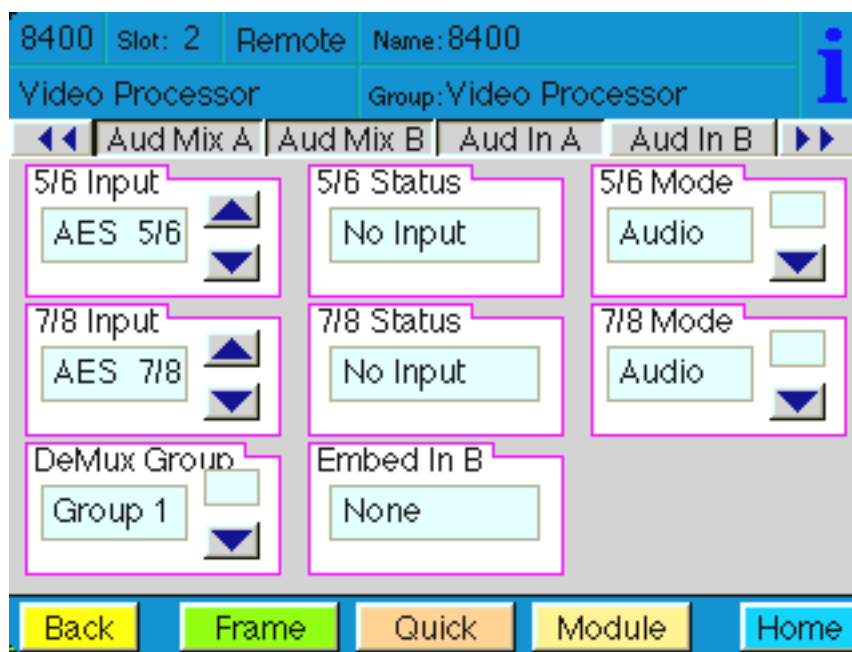

Use the **Aud Delay** menu shown below for all versions of Audio submodule to adjust the amount of audio delay on the output:

- **Auto Track** – enable auto tracking by selecting **On** or **Off**.
- **Bulk Delay** – set the amount of bulk delay using the left and right arrows or enter a value in the **msec** field and press the **Enter** key on your PC..

The amount of total delay will be reported in msec in the **Total Delay** window.

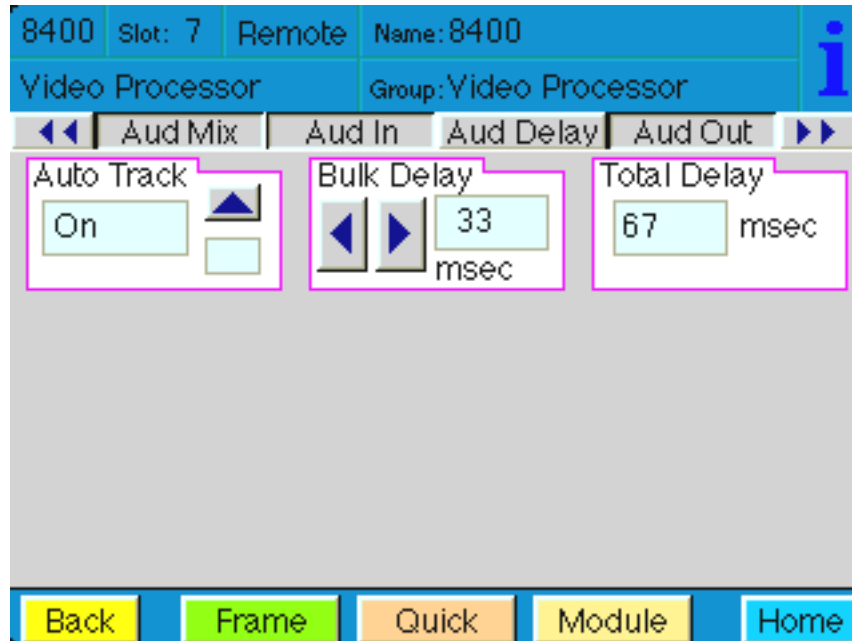

8410 and 8510: Use the **Aud Out** menu shown below to adjust the following audio output parameters:

- **Audio Embed** – turn embedding **Off** for no embedding in the output signal. To embed an audio group, select the position to embed from either **Cascade** (next available audio group) or **Replace** (replace all groups).
- **Mux Group** – select the multiplexed group to be embedded in the output.
- **Anlg Lvl Out** (only for 8510) – set the output level of the analog audio.
- **Dig Ref Level** – set the digital reference level for the audio output.

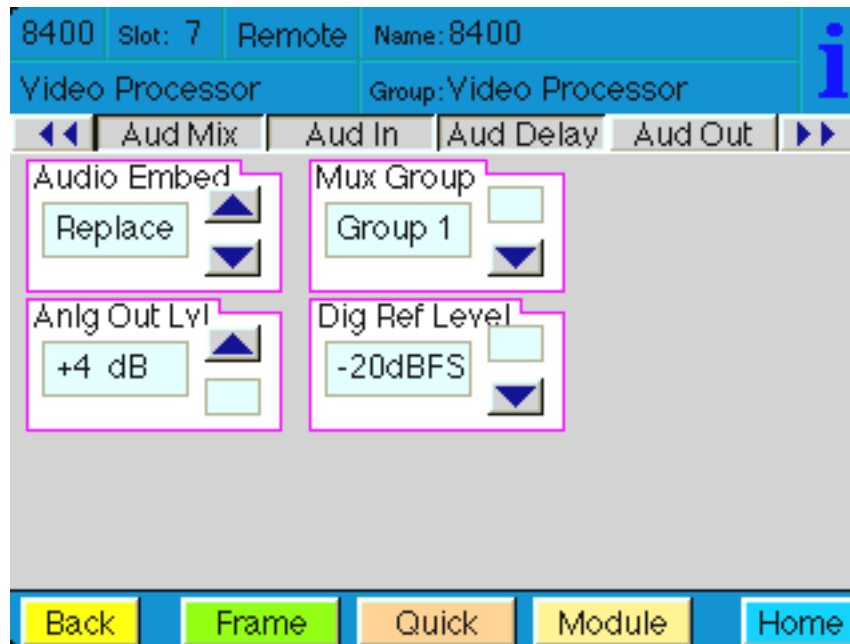

8415: Use the **Aud Out** menu shown below to adjust the following audio output parameters:

- **Audio Embed A** – turn embedding **Off** for no embedding to take place in the output signal. Select **Replace** to replace the targeted group in the stream with new content. If there is no such group already present, the new content will be placed in the horizontal interval in normal cascade, following any other content already there. When **Cascade** is selected, the audio channels are placed after any existing content. **Replace All** will strip all of the original content and the new content is placed at the beginning of the horizontal interval.
- **Audio Embed B** – identical to **Audio Embed A** but no **Replace All** function is required as this will occur upstream in the A embedder..
- **Mux Group A** – select the multiplexed group to be embedded in embedder A in the output.
- **Mux Group B** – select the multiplexed group to be embedded in embedder B in the output.
- **Dig Ref Level** – set the digital reference level for the audio output.

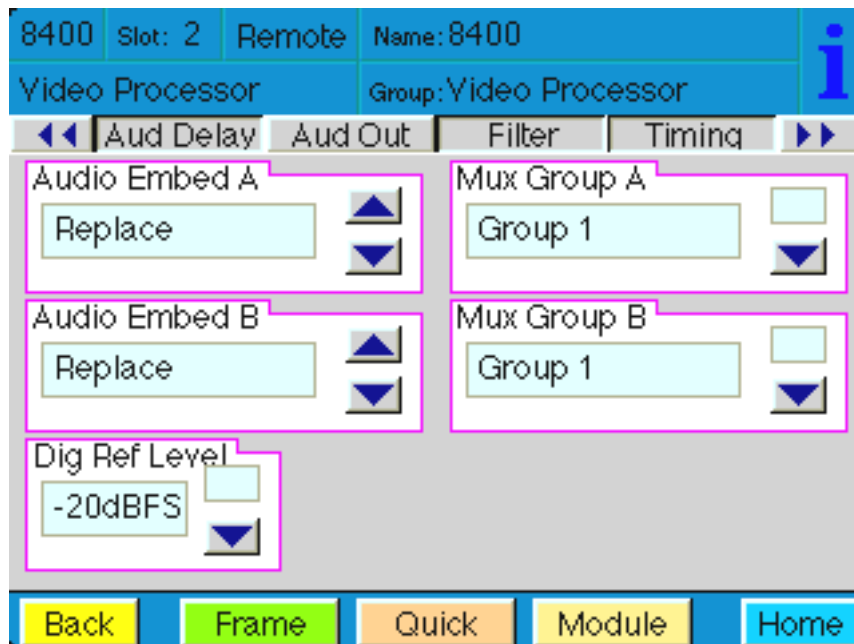

The **Filter** menu shown below allows setting of the luminance and chroma sharpness (with DNR option) with the following detail enhancing controls:

- **Lum Sharp** – set to **Off** to bypass detail enhancing filters. Set to **1/4**, **1/2**, or **Max** to set the sharpness of the luminance portion of the signal.
- **Chr Sharp** – set to **Off** to bypass detail enhancing filters. Set to **1/2**, **1/4**, or **Max** to set the sharpness of the chrominance portion of the signal.

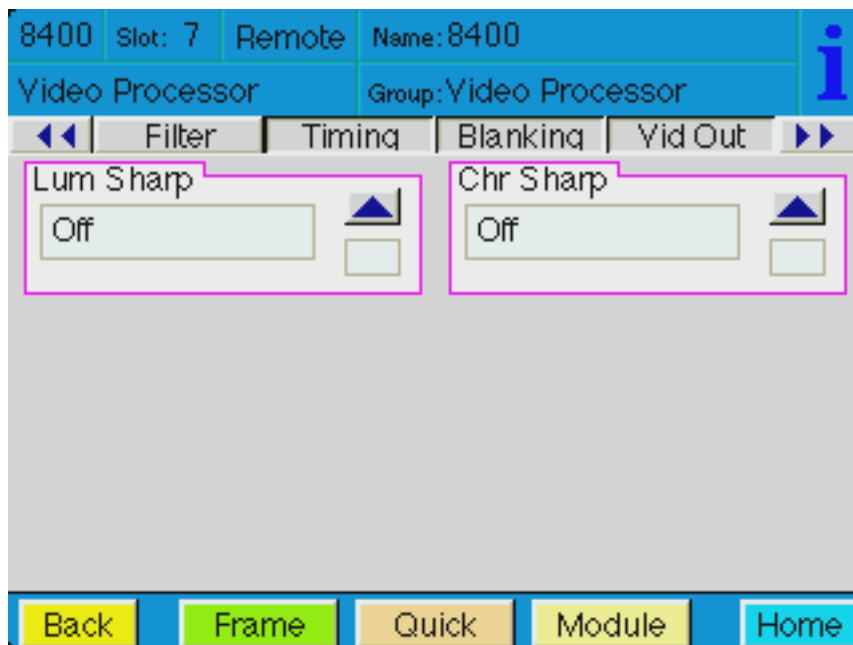

Use the **Timing** menu shown below to adjust the following parameters. For numerical choices, use the slider control to select a value or enter a value into the number field at right and press the **Enter** key on your PC.

- **Fine Phase** – If fine phase will not adjust properly, readjust the horizontal phase by up to ± 2 clocks until the fine phase falls into place.
- **Hor Timing** – adjust the horizontal timing of the output signal to place the leading edge of sync coincident with other sources.
- **Vertical Timing** – set the vertical timing to a typical setting of 0 lines.

This menu provides a **Delay** window at the bottom of the screen that will report the total delay in lines of the module.

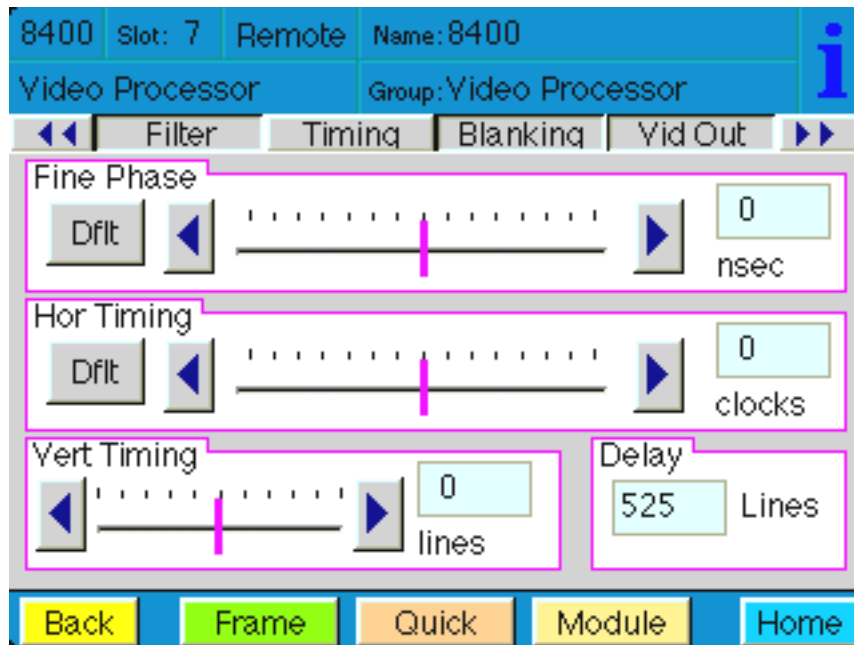

The **Blanking** menu shown below allows you to adjust the output blanking of the module with the following controls:

- **Mode** – set the blanking mode to **Narrow** (lines 1-9 are blanked in NTSC, lines 1-6 in PAL), **Wide** (lines 1-20 in NTSC, lines 1-22 in PAL), or **Custom**.

In **Custom** mode you may select which lines are blanked on a line by line basis in Field 1 and Field 2. A green box indicates the line is blanked. In NTSC, there are individual blanking controls for each line starting with 10 ending with 21. In PAL, there are blanking controls for lines 7 and 8 as one group (both passed or both blank) and individual blanking controls for each line starting with 9 ending with 23.

- **V Bit Pos** – in 525 mode only. Set the position of the vertical bit in the SDI output to **Line 10**, **Line 20**, or **Line 23**.

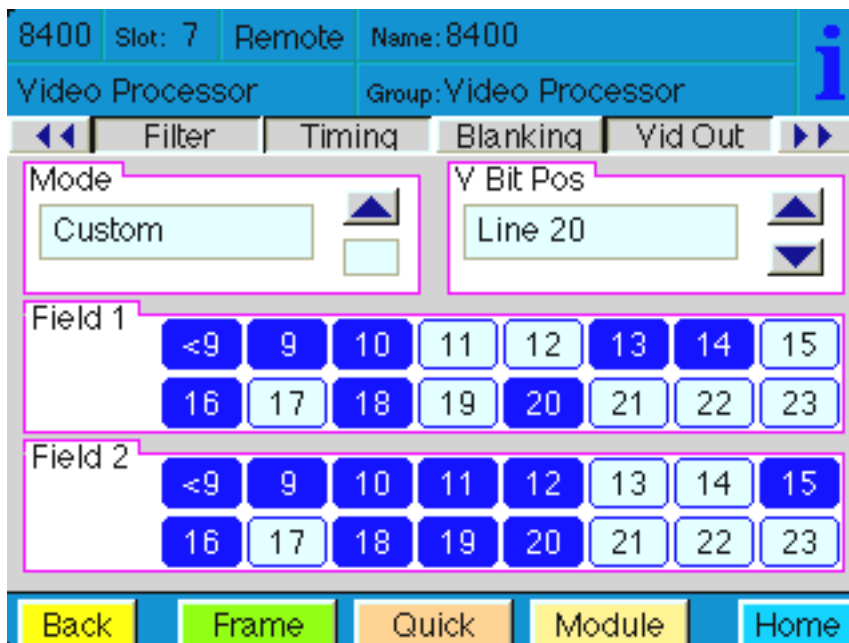

Use the **Vid Out** menu shown below to adjust the following parameters:

- **Bypass** – set to **Normal** for no split screen, **Bypass** to completely bypass any digital processing, or **Split or Split DNR** to enable a split screen comparison between the original input signal (left) and the processed output (right). Use this control in conjunction with the **Bypass** control in the **DNR** menu as described in the summary table on page 35.
- **Strip Audio** – select the box to strip embedded audio from the output. Leave the box unselected to pass embedded audio through to the output.
- **Test Pattern** – select a test pattern to be sent to the video output of the module.
- **Signal Mute** – set to one of the following three choices:
 - 1) **No Muting** – allows the video to pass through regardless of video quality.
 - 2) **Mutes on Noise** – when the module detects the video quality to be unacceptable, the 8400 will output a black signal.
 - 3) **Freezes on Noise** – when the module detects the video quality to be unacceptable, the 8400 will freeze and output the last good field of video.

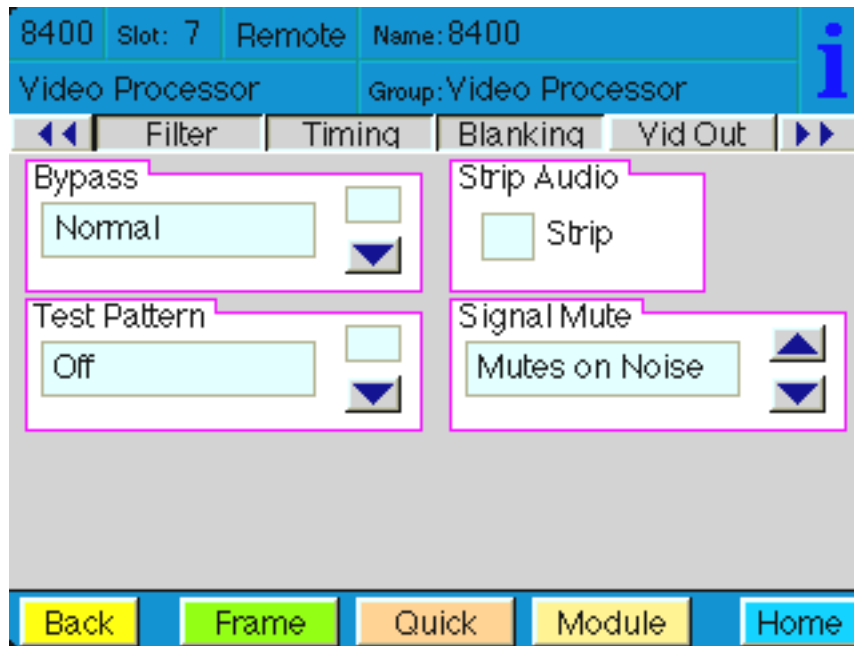

The **Memory** menu shown below allows you to save overall module setups into up to five memory registers as follows:

- Select **Save**, then one of the five memory registers **Reg 1 – 5**. The box will turn green. The entire module setup is now saved in the selected register.
- To recall a register, select the register box. If there is information saved, the box will turn green. The saved setup will now be loaded to the module. Up to five different module setups can be saved and recalled using the individual registers.

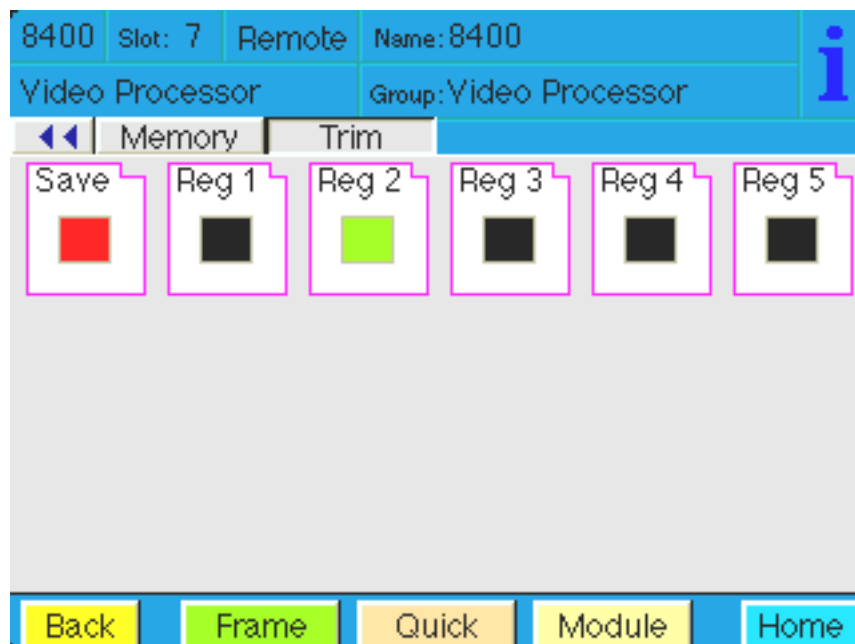

The **Trim** menu allows you to correct subtle issues in the individual color difference channels with offset and gain controls. The offset controls adjust the DC offsets above or below the nominal points. This can be used to correct black balance errors. The gain controls adjust the amplitude of each channel. It is helpful to set the output of the module to **Split Screen** (in the **Vid Out** menu) to allow viewing a comparison of the processed signal to the input while adjusting the controls below.

Use the controls described below to make the offset and gain corrections. For numerical choices, use the slider control to select a value or enter a value into the number field at right and press the **Enter** key on your PC.:

- **Cb Offset** – adjust the DC offset of the Cb channel to between ± 300 IRE.
- **Cr Offset** – adjust the DC offset of the Cr channel to between ± 300 IRE.
- **Cb Gain** – adjust the amplitude of the Cb channel to between ± 20 IRE.
- **Cr Gain** – adjust the amplitude of the Cr channel to between ± 20 IRE.

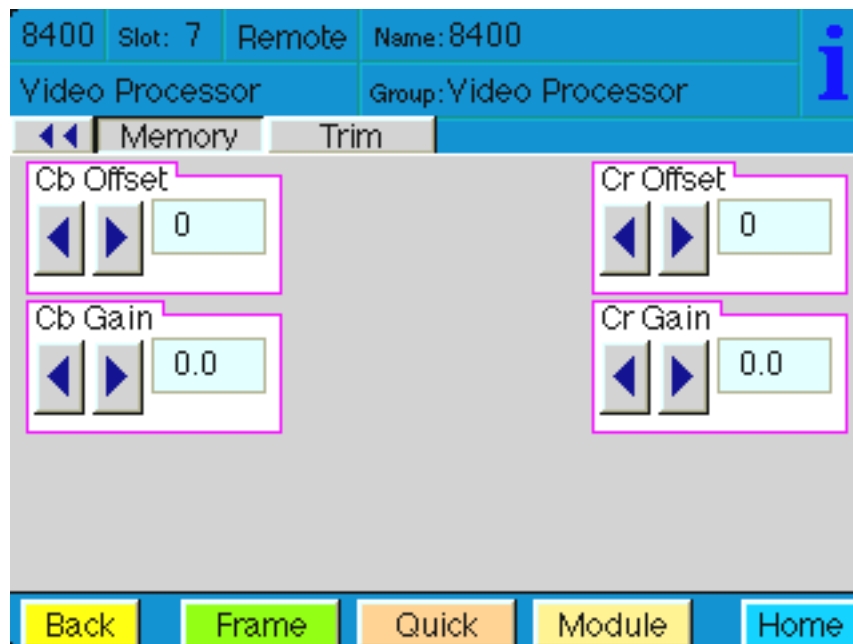

TROUBLESHOOTING

As a troubleshooting aid, the reference signal status and presence, power and CPU status can be easily monitored from the front panel of this module using the front panel indicators.

Refer to the overall troubleshooting tips given below for the module:

Can't control module:

- Check status of CPU **Run** green LED. Should be blinking slowly and in unison with other modules if System module is present. If not, try removing it and plugging it in again to be sure it is seated properly.
- System module may not be working properly if installed.

Module controls are grayed out:

- Module is locked or access to module controls is restricted by User Level.
- Local/Remote switch on module is in the **Local** position.

No signals out of module:

- Check status of **Active** LEDs. Primary or Secondary should be lit. If not, check all inputs for presence and quality.
- Check cabling to inputs of module.
- Check inputs to destinations are terminated properly.

You may also refer to the technical support section of the Ensemble Designs web site for the latest information on your equipment at the URL below:

<http://www.ensembledesigns.com/support>

SOFTWARE UPDATING

Software upgrades for each module can be downloaded remotely if the optional System Control module is installed. These can be downloaded onto your PC and then Avenue PC will distribute the update to the individual module. (Refer to the Avenue PC documentation for more information). Periodically updates will be posted on our web site. If you do not have the required System Control Module and Avenue PC, modules can be sent back to the factory for software upgrades.

WARRANTY AND FACTORY SERVICE

Warranty

This module is covered by a five year limited warranty, as stated in the main Preface of this manual. If you require service (under warranty or not), please contact Ensemble Designs and ask for customer service before you return the unit. This will allow the service technician to provide any other suggestions for identifying the problem and recommend possible solutions.

Factory Service

If you return equipment for repair, please get a Return Material Authorization Number (RMA) from the factory first.

Ship the product and a written description of the problem to:

Ensemble Designs, Inc.

Attention: Customer Service RMA #####

870 Gold Flat Rd.

Nevada City, CA. 95959 USA

(530) 478-1830

Fax: (530) 478-1832

service@ensembledesigns.com

<http://www.ensembledesigns.com>

Be sure to put your RMA number on the outside of the box.

SPECIFICATIONS

8400 Video Processor

Serial Digital Input

Type:	ITU-R601, SMPTE 259M-Compliant
EDH:	Fully Compliant
Impedance:	75 Ω , BNC
Return Loss:	15 dB
Max Cable Length:	300 meters, Belden 1694A

Reference Input

Number:	1 external 1 internal Master Timing Ref
Type:	1V p-p Composite Video PAL or NTSC
Impedance:	75 Ω , BNC
Return Loss:	> 40 dB
Passes entire SDI signal from input to output, including embedded audio and all other ancillary data	

Serial Digital Outputs

Number:	2 (plus 2 additional available by configuring AES BNCs as SDI outputs with onboard switches)
Type:	ITU-R601, SMPTE 259M-C
EDH:	Fully Compliant
Impedance:	75 Ω , BNC
Return Loss:	> 15 dB
Output DC:	None (AC coupled)

General

Power Consumption:	10 watts (with both options installed)
Temperature:	0 to 40° C ambient (all specifications met)
Relative Humidity:	0 to 95%, noncondensing
Size:	Standard Avenue Module Occupies one slot in 3 RU or 1 RU Frame (including one 8410 or 8510 and one 8520 sub module)

General

Power Consumption: 10 watts (with both options installed)
Temperature: 0 to 40° C ambient (all specifications met)
Relative Humidity: 0 to 95%, noncondensing

Size: Standard Avenue Module
Occupies one slot in 3 RU
or 1 RU Frame (including 8510 and 8520)

8410 Audio Processor

AES/EBU Digital Inputs

Number: 2 (Total of four channels)
Type: AES3id
Connectorization: Coaxial, 75 Ω BNC
Bit Depth: 20 and 24 Bit
Sample Rate: 30 kHz to 100 kHz
(Sample Rate Converted internally to 48 kHz)
Reference Level: -18 or -20 dBFS (Selectable)
AC-3, Dolby-E: Supported when inputs are synchronous

Embedded Inputs

Number: One (from SDI video input)
Type: SMPTE 274M Compliant
Selectable to any of four groups
Channels: Four
Bit Depth: 20 or 24 Bit

AES/EBU Digital Outputs

Number: 2 (Total of four channels)
Type: AES3id
Connectorization: Coaxial, 75 Ω BNC
Bit Depth: 20 and 24 Bit
Sample Rate: 48 kHz
Synchronous to Video output
Reference Level: -18 or -20 dBFS (Selectable)

Embedded Output

Number: Two (SDI Output)
Type: SMPTE 274M Compliant
Group Assign: Cascade, or Replace any of four groups
Channels: Four
Bit Depth: 20 or 24 Bit

8415 Audio Processor**AES/EBU Digital Inputs**

Number:	4 (Total of eight channels)
Type:	AES3id
Connectorization:	Coaxial, 75 Ω BNC
Bit Depth:	20 and 24 Bit
Sample Rate:	30KHz to 100 kHz (Sample Rate Converted internally to 48 kHz)
Reference Level:	-18 or -20 dBFS (Selectable)
AC-3, Dolby-E:	Supported when inputs are synchronous

Embedded Inputs

Number:	4 (from SDI video input) 8 channels from any 2 of 4 groups Selectable to any of 4 groups
Type:	SMPTE 274M Compliant Selectable to any of four groups
Channels:	4
Bit Depth:	20 or 24 Bit

AES/EBU Digital Outputs

Number:	4 (Total of eight channels)
Type:	AES3id
Connectorization:	Coaxial, 75 Ω BNC
Bit Depth:	20 or 24 Bit
Sample Rate:	48 kHz Synchronous to Video output
Reference Level:	-18 or -20 dBFS (Selectable)

Embedded Output

Number:	4 or 2, depending on configuration
Type:	SMPTE 274M Compliant
Group Assign:	Cascade, or Replace any of 2 of four groups
Bit Depth:	20 or 24 Bit

8510 Audio Processor

Analog Inputs

Number:	Configurable as 2 or 4
Type:	Balanced
Impedance:	> 15k Ω
Maximum Input Level:	24 dBu
CMRR:	> 60dB, 20Hz to 10 kHz
Quantization:	24 bits, 12x Oversampled
Sample Rate:	48 kHz
Reference Level:	-10 dBu to +4 dBu
Frequency Response:	\pm 0.1dB, 20 Hz to 20 kHz
Crosstalk:	< 96 dB
Dynamic Range:	> 102 dB

AES/EBU Digital Inputs

Number:	2 (Total of four channels)
Type:	AES3id
Connector Type:	Coaxial, 75 Ω BNC
Bit Depth:	20 or 24 Bit
Sample Rate:	30 kHz to 100 kHz (Sample Rate Converted internally to 48 .kHz)
Reference Level:	-18 or -20 dBFS (Selectable)
AC-3, Dolby-E:	Supported when inputs are synchronous

Embedded Inputs

Number:	1 (From SDI video input)
Type:	SMPTE 274M Compliant Selectable to any of four groups
Channels:	4
Bit Depth:	20 or 24 Bit

Analog Outputs

Number:	Configurable as 2 or 4
Type:	Balanced, transformerless
Impedance:	30 Ω
Maximum Output Level:	24 dBu
Resolution:	24 bits, 128x Oversampled
Reference Level:	-10 dBu to +4 dBu
Frequency Response:	\pm 0.1dB, 20 Hz to 20 kHz
Crosstalk:	< 96 dB
Dynamic Range:	> 102 dB

AES/EBU Digital Outputs

Number: 2 (Total of four channels)
 Type: AES3id
 Connector Type: Coaxial, 75 Ω BNC
 Bit Depth: 20 or 24 Bit
 Sample Rate: 48 kHz
 Synchronous to Video output
 Reference Level: -18 or -20 dBFS (Selectable)

Embedded Output

Number: One (SDI Output)
 Type: SMPTE 274M Compliant
 Group Assign: Cascade, or Replace any of four groups
 Channels: 4
 Bit Depth: 20 or 24 Bit

8520 Digital Noise Reducer

Functional

Modes: Manual Adaptive
 Automatic (low gain)
 Automatic (high gain)
 Processing: Temporal, Recursive
 Configurations: Independent Luma / Chroma
 Chroma tied to Luma
 Through Delay: < 4 μ Sec
 Resolution: 12 bit internal processing

Controls

Gain: 0 to 20 dB
 Threshold: 0.1 to 10.0 IRE

Status & Display

Automatic Mode: Displays derived Gain and Threshold
 Video Out: Normal
 Show Noise
 Split Screen

Due to ongoing product development, all specifications subject to change.