

AVENUE

Avenue™ signal integration system

Model 6030 Video-Referenced AES/Word Clock Generator Data Pack

GRAHAM-PATTEN
The sound choice.

Revision 3.1 SW v1.0.0

This data pack provides detailed installation, configuration and operation information for the **Model 6030 Video-Referenced AES/Word Clock Generator** module as part of the Avenue Signal Integration System.

The module information in this data pack is organized into the following sections:

- Module Overview
- Applications
- Installation
- Cabling
- Module Configuration and Control
 - Front Panel Controls and Indicators
 - Avenue PC Remote Control
 - Avenue Touch Screen Remote Control
- Troubleshooting
- Software Updating
- Warranty and Factory Service
- Specifications

MODULE OVERVIEW

The 6030 Video-Referenced AES/Word Clock Generator provides silent AES and word clock outputs that are locked to a reference video input such as house color black. This allows digital audio equipment accepting AES or word clock signals to lock to a common reference produced by the module.

As shown in the block diagram below, you may choose to use a master NTSC or PAL video reference to the Avenue frame which is distributed to all the frame modules by the optional System Control module, or an NTSC or PAL video reference connected directly to the 6030 reference input. In the absence of an external video reference, an on-board oscillator will be selected as a reference. The video signal is processed to provide six AES outputs and two word clock outputs on BNCs at the rear of the frame.

Front panel indicators are provided for monitoring the presence of the external video reference, the on-board internal reference, the ability of the module to lock to the video reference as well as power and CPU status.

Control of the module can be from one of the remote Avenue options or from the local controls on the front of the module. The on-board microprocessor communicates with the frame for remote control via the System Control module if installed. Module ID (slot location, software version and board revision) and status information can be monitored by the frame System Control module and read using the remote control options available. Software alarms can also be enabled from the remote control options in addition to a hardware alarm output from the rear 15-pin connector.

Power is derived from the ± 12 volt frame power. It is regulated to the required +5 volts for the module by an on-board regulator. The module is fused with a resettable fuse device. If the fuse opens due to an overcurrent condition, the module will lose power. After pulling the module, the fuse will reset automatically requiring no replacement fuse.

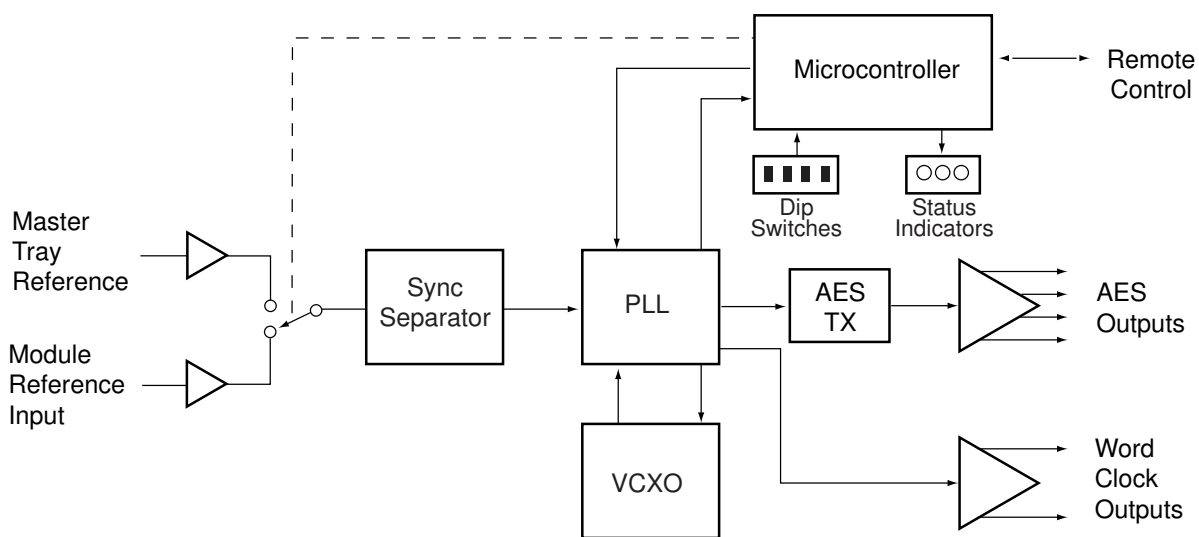

6030 Video-Referenced AES/Word Clock Generator Functional Block Diagram

APPLICATIONS

In most video applications, it is essential that AES sample clocks be locked to a video reference. In the application shown below, a single 6030 module is used to provide video-locked AES references to multiple 6010 Audio ADC modules.

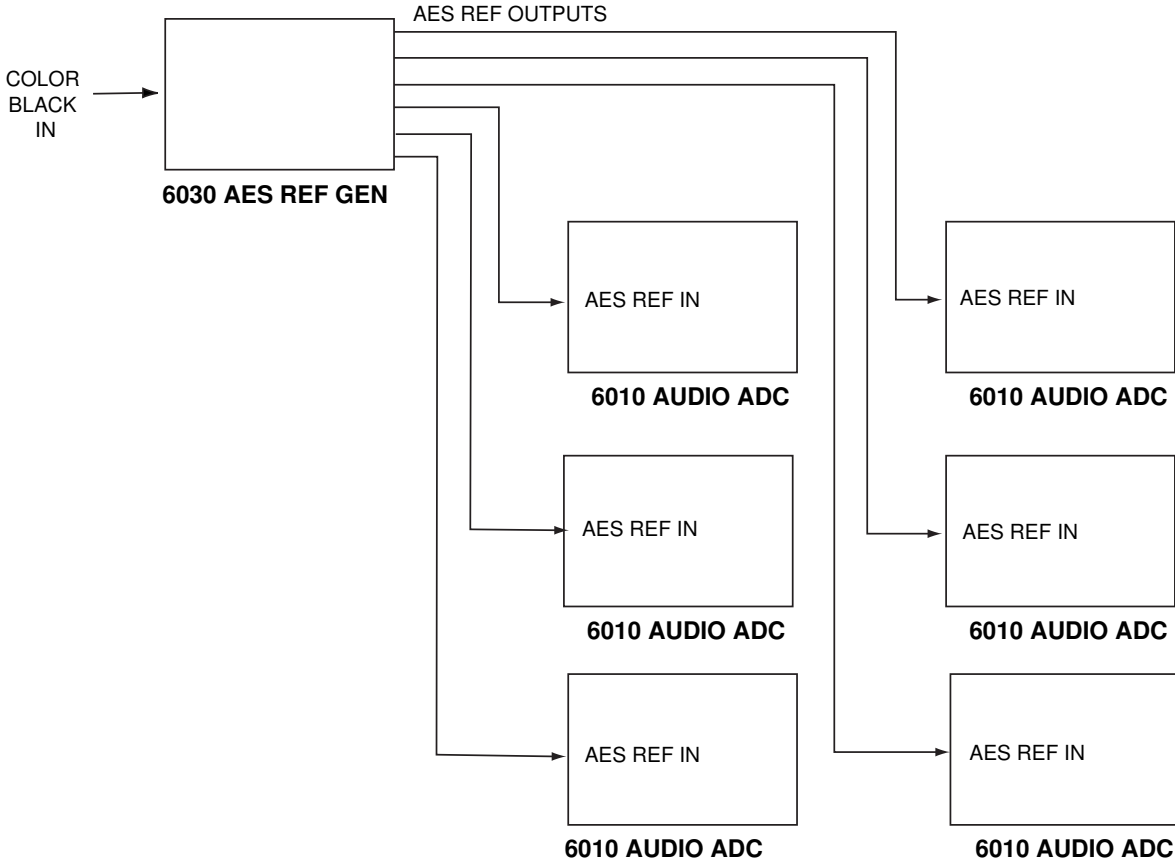

Single 6030 AES Reference Outputs Feeding Multiple 6010 Audio ADCs

Model 6030 Video-Referenced AES/Word Clock Generator

In the application shown below, a 6030 module is used as master AES reference for an entire facility. One of the 6030 AES outputs is used as a silent AES signal (“digital audio black”). Two more outputs are used to lock test signal generators that are used as a source of test tones. A fourth AES output is used to lock to other digital audio equipment in the facility. A configuration such as this ensures that all sources in the facility are locked to video and are synchronous with respect to one another. This reduces the likelihood of pops, clicks, or other undesirable artifacts when switching between sources.

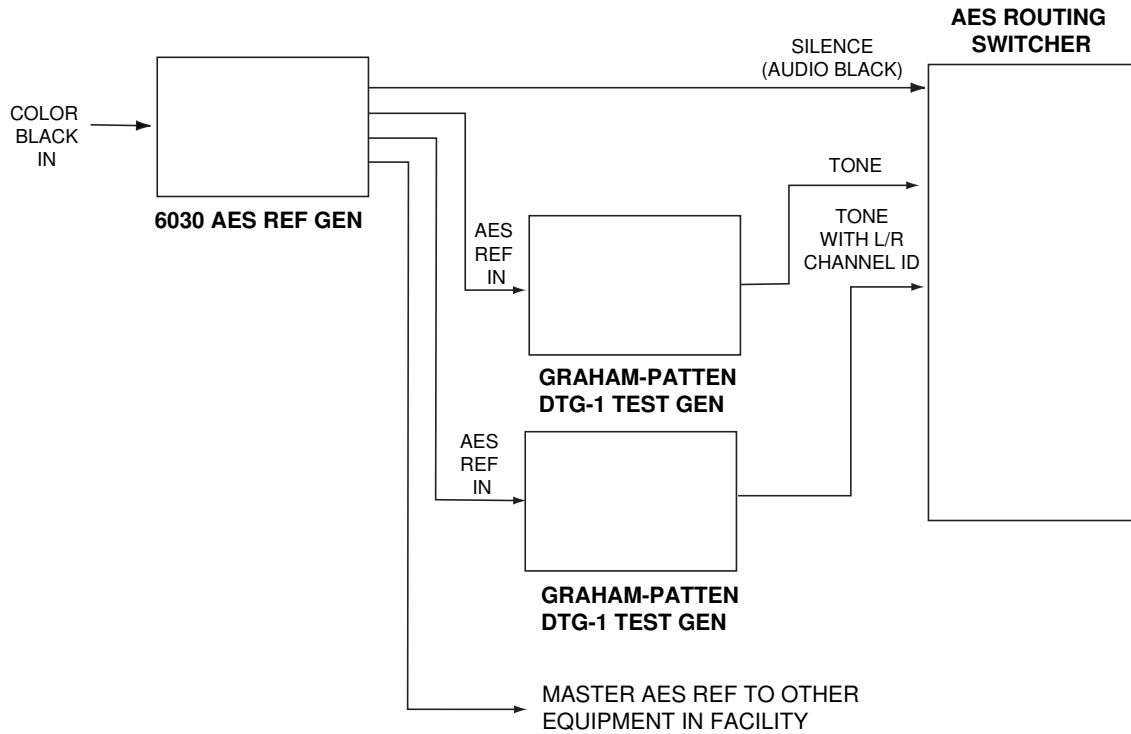

6030 Outputs As Master Reference for Entire Facility

Model 6030 Video-Referenced AES/Word Clock Generator

In the application below, a 6030 module is once again used as a master AES reference for an entire facility. One of the 6030 AES outputs is used as a silent AES signal (“audio black”). The remaining five AES outputs are used to lock to other digital audio equipment. The word clock outputs of the 6030 are used to lock a digital audio workstation and a nonlinear video editing system to the rest of the equipment in the facility.

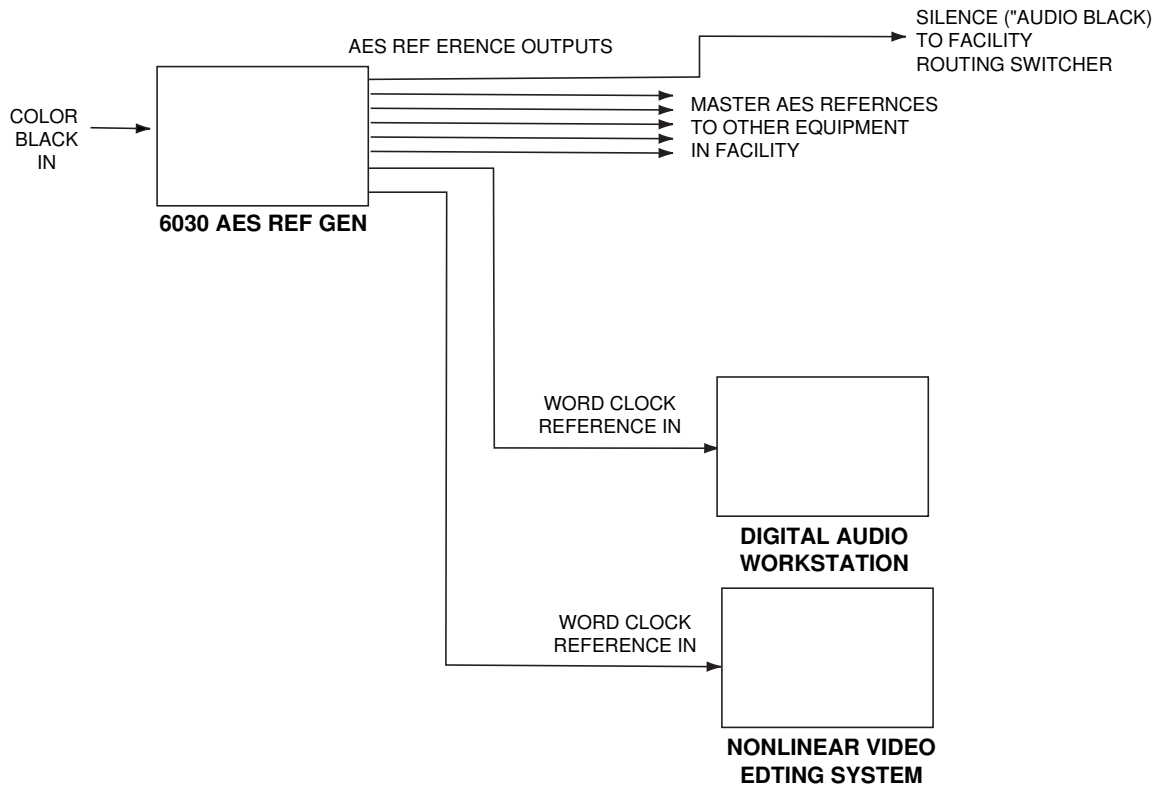

6030 Outputs As Master AES, Silence and Word Clock Facility References

INSTALLATION

Plug the 6030 module into any one of the ten slots in the frame and install the plastic overlay provided onto the corresponding group of rear BNC connectors associated with the module location. Note that the plastic overlay has an optional adhesive backing for securing it to the frame. Use of the adhesive backing is only necessary if you would like the location to be permanent and is not recommended if you need to change module locations. This module may be hot-swapped (inserted or removed) without powering down or disturbing performance of the other modules in the system.

CABLING

Refer to the backplane diagram of the module below for cabling instructions.

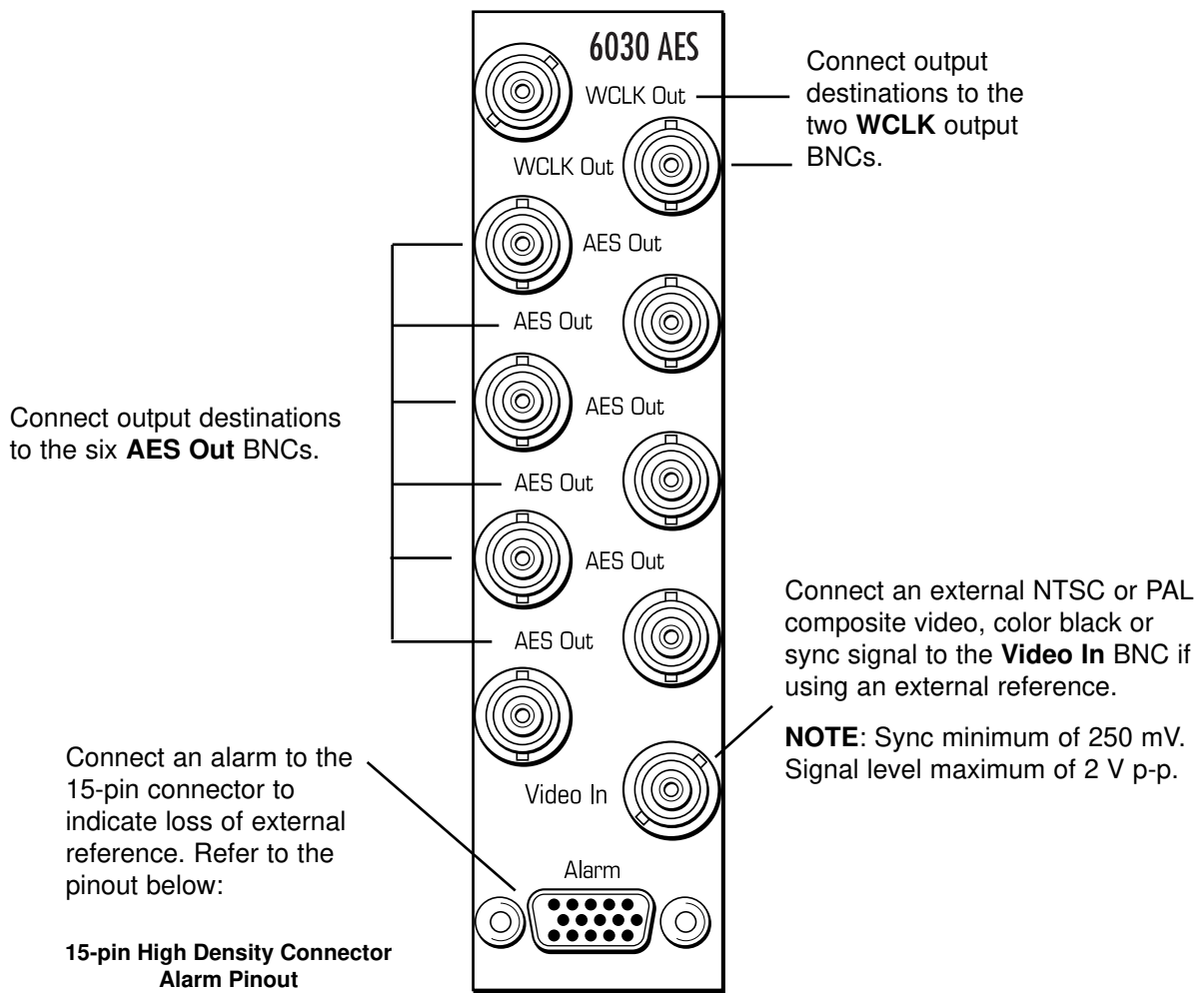

15-pin High Density Connector Alarm Pinout

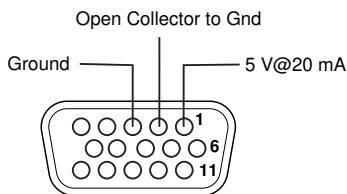

Wiring Side-Male Plug

MODULE CONFIGURATION AND CONTROL

The parameters for each Avenue module must be configured after installation. This can be done remotely using one of the Avenue remote control options or locally using the module front panel controls. Each module has a **REMOTE/LOCAL** switch on the front edge of the circuit board which must first be set to the control mode you will be using.

The configuration parameter choices for the module will differ between **Remote** and **Local** modes. In **Remote** mode, the choices are made through software and allow more selections. The **6030 Parameter Table** below summarizes and compares the various configuration parameters that can be set remotely or locally and the default/factory settings.

If you are not using an remote control option, the module parameters must be configured from the front panel switches. Parameters that have no front panel control will be set to a default value. The **Local** switches are illustrated in the **Front Panel Controls and Indicators** section following the **6030 Parameter Table**.

Avenue module parameters can be configured and controlled remotely from one or both of the remote control options, the Avenue Touch Screen or the Avenue PC Application. Once the module parameters have been set remotely, the information is stored on the module CPU. This allows the module be moved to a different cell in the frame at your discretion without losing the stored information. Remote configuration will override whatever the switch settings are on the front edge of the module.

For setting the parameters remotely using the Avenue PC option, refer to the **Avenue PC Remote Configuration** section of this document.

For setting the parameters remotely using the Avenue Touch Screen option, refer to the **Avenue Touch Screen Remote Configuration** section of this data pack following Avenue PC.

6030 Parameter Table

CONTROL	LOCAL	REMOTE	DEFAULT VALUE
Video Standard	Front Panel Switch: PAL (right) NTSC (left)	NTSC PAL	N/A
Lock Mode	Front Panel Switch: Int (right) Auto (left)	Auto Switch Internal	N/A
Ref Source	Front Panel Switch: Tray Ref (On - right) (Off - left)	Module Ref Tray Ref	N/A
Loss of Ref	Front Panel Switch: Mute (On - right) (Off - left)	Free run Mute Output	N/A

Front Panel Controls and Indicators

Each front edge indicator and switch setting is explained in the diagram below:

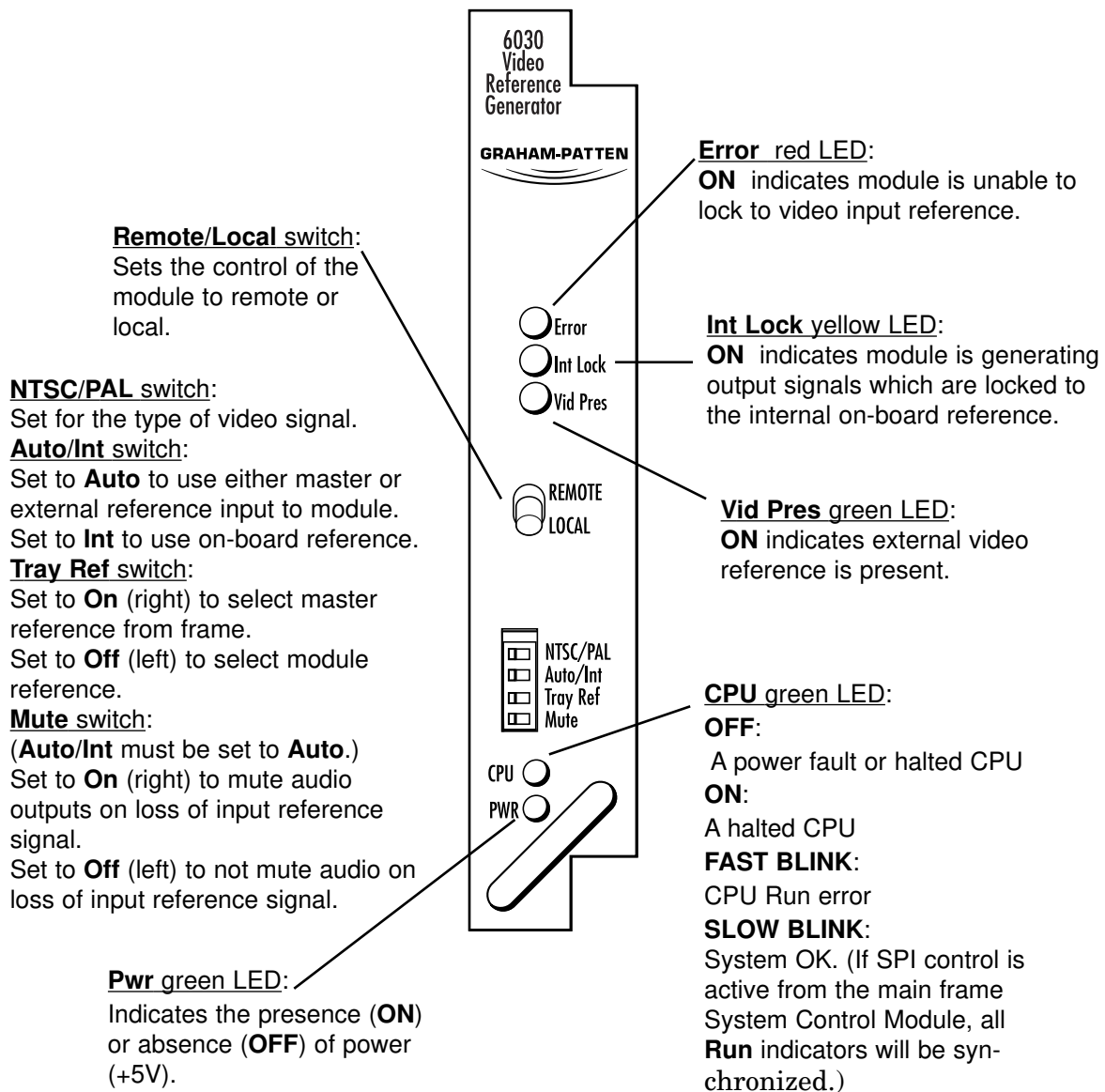

Avenue PC Remote Configuration

The Avenue PC remote control menus for this module are illustrated and explained in this section. Refer to the **6030 Parameter Table** shown earlier for a summary of available parameters that can be set remotely through the menus illustrated. For more information on using Avenue PC, refer to the Avenue PC Control Application Software data pack that came with the option.

6030 Avenue PC Menus

In the **Main Menu** shown below, set the following parameters:

- **Video Standard** – select a video standard conforming to **NTSC** or **PAL** standards.
- **Lock Mode** – set module lock to **Auto Switch** (AES output will lock to reference video if available or internal crystal if no reference video) or **Internal** (AES output will always lock to internal crystal).
- **Ref Source** – set the module reference to be **Module Ref** (Reference video will be supplied to BNC 1 on the rear module backplane) or **Tray Ref** (Reference will be supplied by the common input reference from the Master Reference Input BNC on the frame backplane. System Control Module is required for this function.)
- **Loss of Ref** – choose either **Free Run** (AES output will free-run using the internal crystal if reference video is lost and Lock Mode is set to Auto Switch) or **Mute Output** (AES output will be muted if reference video is lost and Lock Mode is set to Auto Switch).

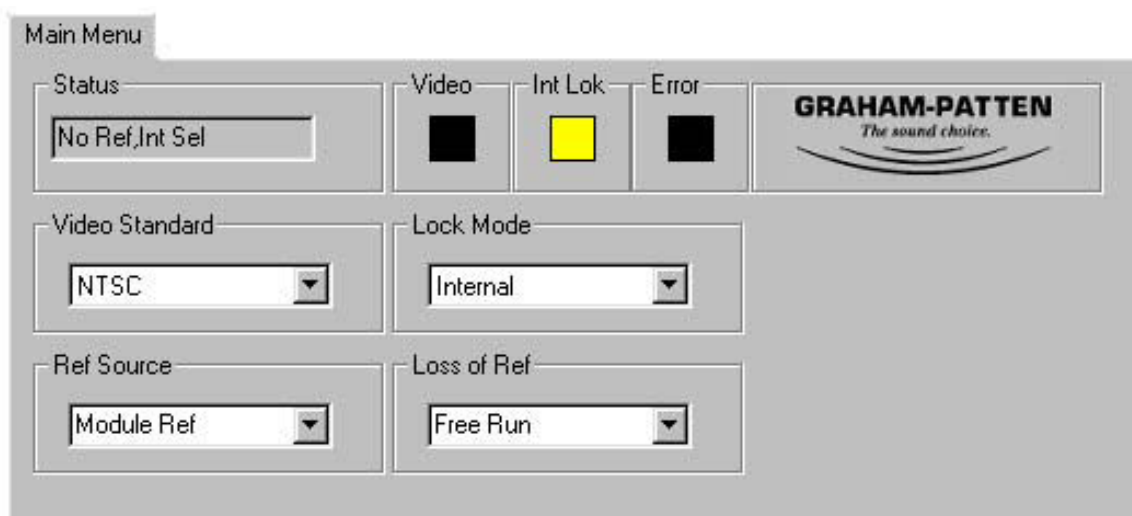

In this menu, the following indicators are available:

- **Status** - displays one of nine different status messages about the module:
 1. Bad Ref,Locking –Reference video is out of range for AES lock and may be intermittent, but module is attempting to achieve lock. Output is not muted regardless of Loss of Ref selection.
 2. Ref Lst,Int Lok – Reference video is not present or not recognized. AES output is locked to internal crystal reference on module.
 3. Ref Lst,Mute OP – Reference video is not present or not recognized. AES output is muted.
 4. External Lock – AES output is locked to reference video.
 5. Ref OK,Int Sel – Reference video is present but Lock Mode is set to Internal.
 6. No Ref,Int Sel – Reference video is not present or not recognized but Lock Mode is set to Internal.
 7. Bad Ref,Mute OP – Reference video is intermittent or unstable. Module is attempting to achieve lock when reference video is recognized but will mute the AES output when reference video is not recognized.
 8. Bad Ref,Int Sel – Reference video is intermittent or unstable but Lock Mode is set to Internal.
 9. Blank Display – Current state is only transient while conditions are changing.
- **Video** Box Indicator – One of three display styles will be presented:
 - Green** – Reference Video from the selected source is recognized.
 - Green/Gray (blink)** – Reference is intermittently recognized (bad reference)
 - Black** – No reference video from the selected source is recognized.
- **Int Lock** Box Indicator – One of three display styles will be presented:
 - Yellow** – AES output is locked to internal crystal.
 - Yellow/Gray (blink)** – AES output is switching between locking to internal crystal and reference video (will occur when **Video** color box is also blinking.)
 - Black** – AES output is locked to reference video.
- **Error** Box Indicator – One of two display styles will be presented:
 - Red** – AES signal cannot be locked to reference video.
 - Black** – AES signal is locked to reference video if reference video is present and Lock Mode is not set to Internal.

Avenue Touch Screen Remote Configuration

Avenue Touch Screen remote control menus for this module are illustrated and explained below. Refer to the **6030 Parameter Table** shown earlier for a summary of available parameters that can be set remotely through the menus illustrated. For more information on using Avenue Touch Screen, refer to the Avenue Touch Screen data pack that came with the option.

6030 Avenue Touch Screen Menus

In the **Main Menu** shown below, set the following parameters:

- **Ref Video Standard** – select a video reference standard conforming to **NTSC** or **PAL** standards.
- **Lock Mode** – set module lock to **Auto Switch** (AES output will lock to reference video if available or internal crystal if no reference video) or **Internal** (AES output will always lock to internal crystal).
- **Ref Source** – set the module reference to be **Module Ref** (Reference video will be supplied to BNC 1 on the rear module backplane) or **Tray Ref** (Reference will be supplied by the common input reference from the Master Reference Input BNC on the frame backplane. System Control Module is required for this function.)
- **Loss of Ref** – choose either **Free Run** (AES output will free-run using the internal crystal if reference video is lost and Lock Mode is set to Auto Switch) or **Mute Output** (AES output will be muted if reference video is lost and Lock Mode is set to Auto Switch).

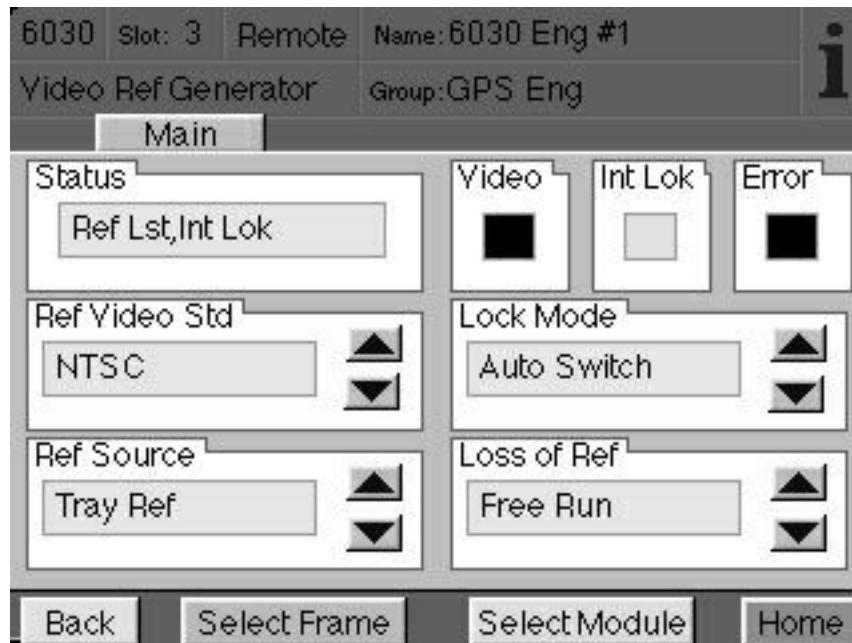

In this menu, the following indicators are available:

- **Status** - displays one of nine different status messages about the module:
 1. Bad Ref,Locking –Reference video is out of range for AES lock and may be intermittent, but module is attempting to achieve lock. Output is not muted regardless of Loss of Ref selection.
 2. Ref Lst,Int Lok – Reference video is not present or not recognized. AES output is locked to internal crystal reference on module.
 3. Ref Lst,Mute OP – Reference video is not present or not recognized. AES output is muted.
 4. External Lock – AES output is locked to reference video.
 5. Ref OK,Int Sel – Reference video is present but Lock Mode is set to Internal.
 6. No Ref,Int Sel – Reference video is not present or not recognized but Lock Mode is set to Internal.
 7. Bad Ref,Mute OP – Reference video is intermittent or unstable. Module is attempting to achieve lock when reference video is recognized but will mute the AES output when reference video is not recognized.
 8. Bad Ref,Int Sel – Reference video is intermittent or unstable but Lock Mode is set to Internal.
 9. Blank Display – Current state is only transient while conditions are changing.
- **Video** Box Indicator – One of three display styles will be presented:
 - Green** – Reference Video from the selected source is recognized.
 - Green/Gray (blink)** – Reference is intermittently recognized (bad reference)
 - Black** – No reference video from the selected source is recognized.
- **Int Lock** Box Indicator – One of three display styles will be presented:
 - Yellow** – AES output is locked to internal crystal.
 - Yellow/Gray (blink)** – AES output is switching between locking to internal crystal and reference video (will occur when **Video** color box is also blinking.)
 - Black** – AES output is locked to reference video.
- **Error** Box Indicator – One of two display styles will be presented:
 - Red** – AES signal cannot be locked to reference video.
 - Black** – AES signal is locked to reference video if reference video is present and Lock Mode is not set to Internal.

TROUBLESHOOTING

For troubleshooting purposes, signal presence, module locking status, power and CPU status can be easily monitored from the front panel of this module using the indicators explained in the previous section.

If using the **Remote** mode, the following status items can be monitored using the Avenue Touch Screen Control Panel or PC Application:

- Module status messages
- External reference present and outputs locked
- Module is generating signals locked to internal crystal oscillator
- Module is unable to lock to video reference
- Slot ID, Software Version and Board Revision

Refer to the overall troubleshooting tips given below for the **6030** module:

No status lights are lit on front panel:

- Check that frame power is present (green LED{s} on frame power supplies).
- Check that module is firmly seated in frame. Try removing it and plugging it in again.

Can't control module:

- Check status of CPU **Run** red LED. Should be blinking slowly and in unison with other modules if System module is present. If not, try removing it and plugging it in again.
- System module may not be working properly if installed.

No status lights are lit on front panel:

- Check that frame power is present (green LED{s} on frame power supplies).
- Check that module is firmly seated in frame. Try removing it and plugging it in again.

Can't lock to Ext Ref indication:

- Check for presence and validity of external reference input signal.

No AES clock signal out of module:

- Check cabling to input of module.

You may also refer to the technical support section of the Ensemble or Graham-Patten web sites for the latest information on your equipment at the URLs below:

<http://www.ensembledesigns.com/support>

<http://www.gpsys.com>

SOFTWARE UPDATING

Software upgrades for each module can be downloaded remotely if the optional System Control module is installed. These can be downloaded onto your PC and then Avenue PC will distribute the update to the individual module. (Refer to the Avenue PC documentation for more information) Periodically, updates will be posted on our web site. If you do not have the required System Control Module and Avenue PC, modules can be sent back to the factory for software upgrades.

WARRANTY AND FACTORY SERVICE

Warranty

This Module is covered by a five year limited warranty, as stated in the main Preface of this manual. If you require service (under warranty or not), please contact Ensemble Designs or Graham-Patten Systems and ask for customer service before you return the unit. This will allow the service technician to provide any other suggestions for identifying the problem and recommend possible solutions.

Factory Service

If you return equipment for repair, please get a Return Material Authorization Number (RMA) from the factory first.

Ship the product and a written description of the problem to:

Ensemble Designs, Inc.

Attention: Customer Service RMA #####

870 Gold Flat Rd.

Nevada City, CA. 95959 USA

(530) 478-1830

Fax: (530) 478-1832

service@endes.com

<http://www.ensembledesigns.com>

Be sure to put your RMA number on the outside of the box.

OR

Graham-Patten Systems, Inc.

13366 Grass Valley Avenue

Grass Valley, CA 95945

(800) 422-6662 or (530) 273-8412

Fax: (530) 273-7458

service@gpsys.com

<http://www.gpsys.com>

SPECIFICATIONS

6030 Video-Referenced AES/Word Clock Generator

Reference Input:	Terminating, 75 ohms NTSC or PAL composite video, color black, or sync Minimum sync level 250mV p-p Maximum signal level 2 volts p-p
Frequency Lock Range:	± 50 ppm
Internal Ref Accuracy:	± 10 ppm (AES "grade 2" reference)
Sample Rate:	48kHz
AES3id Outputs:	1 volt p-p, 75 ohm source terminated
Word Clock Output:	4.5 to 5 volts p-p
Alarm Outputs:	Alarm – +5V, Pin 1 (20 mA maximum) Alarm – 0V, Pin 2 (-20 mA maximum)

Due to ongoing product development, all specifications subject to change without notice.