

The logo for Avenue Signal Integration System features the word "AVENUE" in a bold, sans-serif font. A horizontal line passes through the middle of the letter "V". Below this line, the text "Avenue signal integration system" is written in a smaller, lowercase font. A thick, dashed black line starts from the right side of the horizontal line and extends diagonally downwards towards the bottom right corner of the page.

AVENUE

Avenue signal integration system

Model 4455 ASI Serial Digital Protection Switch Data Pack

ENSEMBLE

D E S I G N S

Revision 1.5 SW v2.2.11

This data pack provides detailed installation, configuration and operation information for the **4455 ASI Serial Digital Protection Switch** module as part of the Avenue Signal Integration System.

The module information in this data pack is organized into the following sections:

- Module Overview
- Applications
- Installation
- Cabling
- Module Configuration and Control
 - Front Panel Controls and Indicators
 - Avenue PC Remote Control
 - Avenue Touch Screen Remote Control
- Troubleshooting
- Software Updating
- Warranty and Factory Service
- Specifications

MODULE OVERVIEW

The 4455 Serial Digital Protection Switch module is a fail-safe protection switch for monitoring and switching critical ASI paths for broadcast or satellite applications.

When a fault is detected in the Primary input and the Secondary input is verified as good, the switch will activate, causing the Secondary input to be switched to the module's output. The 4455 includes a fail-safe bypass which connects the Primary input directly to one of the six module outputs. This passive, fail-safe path ensures that there is an output even in the event of a total power failure.

The 4455 can operate in two modes: automatic or non-resetting. In fully automatic mode, the 4455 will automatically switch back to the Primary signal once it has been restored. In non-resetting mode, the Secondary input remains routed to the output even after the Primary input has recovered. In this case, manual intervention is needed to throw the switch back to the Primary input. With Auto mode turned off, a fault in the Primary signal will generate an alarm but no switching will occur.

ASI SIGNAL EVALUATION

There are three levels of signal analysis for DVB-ASI signal evaluation: **Simple**, **Program Specific**, and **PID Specific**. Use the **ASI Test** control in the **Config** menu to choose among these.

When **ASI Test** is set to **Simple**, the 4455 looks for:

- Input signal presence and digital clock lock;
- Presence of non-null (blank) packets;
- Presence of Program Allocation Table (PAT) PIDs occurring at least two per second.

When **ASI Test** is set to **Program Specific**, the 4455 looks for the above conditions, plus the following:

- The presence of at least one program stream being called for in the Program Management Table (PAT). The 4455 can automatically look for the first one, or the user can tell it which of the first four it should look for. This selection is made with the **Pgm Target** control in the **ASI Config** menu. The 4455 expects at least one PMT PID per second.
- The targeted Program must contain at least one elementary Video Stream and one elementary Audio Stream.
- A user-defined minimum number of video packets each second in the Video PID.
- A user-defined minimum number of audio packets each second in the Audio PID.

When **ASI Test** is set to **PID Specific**, the 4455 looks for the conditions of the Simple ASI Test, plus the following:

- The data rate of specific user-selected PID Targets in an ASI signal. When in PID Specific Mode, you can assign and configure up to 32 "PID Watchers" or "Targets," each tasked to monitor the data rate of their specific PID Target in an ASI signal. You can index through each of the 32 possible targets. Each target (or PID watcher) can be enabled or disabled and each one can be assigned a minimum packet rate. If

any of the enabled watchers fails to collect its assigned data load a switch will be triggered.

- The targeted Program must contain at least one elementary Video Stream and one elementary Audio Stream.
- A user-defined minimum number of video packets each second in the Video PID.
- A user-defined minimum number of audio packets each second in the Audio PID.

The **Pri ASI Status** and **Sec ASI Status** indicators show what has been detected in the incoming DVB-ASI stream.

Possible indications are:

- **Good** – The DVB-ASI signal passes all tests (either Simple or Advanced);
- **No ASI** – No DVB-ASI signal has been detected;
- **No Packets** - All of the packets in the stream are null. There are no actual program packets;
- **No PAT** - There are non-null packets, but no Program Allocation Table can be found;
- **No PMT** - No Program Management Table can be found;
- **No Video** - The user-defined minimum number of video packets per second has not been met;
- **No Audio** - The user-defined minimum number of audio packets per second has not been met.

The **ASI Status** menu shows a breakdown of these elements of analysis with a display of live results. The displayed values for the rate (in PIDs per second) for the video and audio can be used as a guide to setting the **Min Vid Rate** and **Min Aud Rate** values in the **ASI Config** menu for a particular system or installation.

Whenever the ASI test generates a result other than **Good**, such as **No ASI**, or **No Packets**, a timer begins running. If that timer reaches the **ASI Time** value set in the **ASI Config** menu, the channel will be marked as faulted and the switch will move to the Secondary input.

When the program assignments in a DVB-ASI stream change, it can take up to a second for the 4455 detector to re-acquire all of the table information needed to show that the signal is good. For this reason, a setting of between 2 - 5 seconds is recommended for the **ASI Time** parameter in the **ASI Config** menu.

The **Pri Errors** and **Sec Errors** menus show error-seconds counters for all tests performed by the 4455. The **ASI Vid ErrSec** control shows the cumulative number of seconds where the minimum packet rate was not met. Depending on how the **ASI Time** control is set, these errors may or may not have actually caused a program switch to occur. To reset the error-seconds counters, click them.

Model 4455 Serial Digital Protection Switch

The block diagram below illustrates the signal flow of the 4455. Note that in the event of power failure, the passive relay passes the primary input to the Relay Protected Output.

The Primary and Secondary inputs pass through serial digital receiver/equalizers for buffering. When a fault is detected in the Primary input, and the Secondary input is seen as not faulted, the electronic solid state switch will activate, switching the Secondary input to the output.

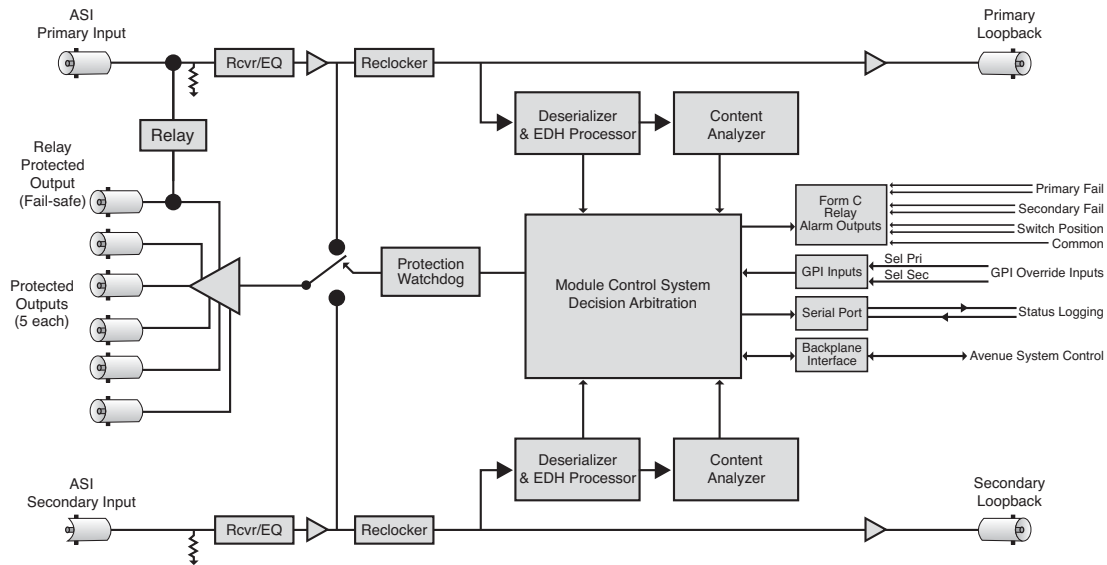

4455 Serial Digital Protection Switch

Each of the signals is fed to identical detection circuits which evaluate multiple parameters and characteristics of the signal in order to arrive at a fault decision. The output of this section then feeds a Field Programmable Gate Array (FPGA) where the signals are vetted, or tested for configured parameters. The Signal Vetter™ process in the FPGA detects the parameters chosen by the user using either the front panel controls or through the Avenue PC or Touch Screen menus. Each of the chosen aspects are monitored independently, and when they fail to meet the vetted standard, a fault condition is issued.

Fault conditions can be monitored with an external alarm system or other device through the 15-pin **Control** connector on the corresponding rear backplane connector. The Form C relays status outputs from this connector can be monitored by a device to show Primary and Secondary signal status and the current position of the protect switch (Primary or Secondary).

Two GPI Override Inputs are available to allow changing switch position in response to triggers from an external source. This can be used to manually reset the switch after the Primary has recovered from a fault condition or set to respond to a signal state from an external device to trigger a switch.

Model 4455 Serial Digital Protection Switch

The on-board CPU can monitor and report module ID information (slot location, software version and board revision), and power status to the optional frame System Control module. This information can be accessed by the user or set to register an alarm if desired using the remote control options available.

Every function and parameter on the module can be controlled from an Avenue Touch Screen Control Panel or the Avenue PC Control Application. Memory registers can be used to save the complete configuration of the module, making it easy to change instantly between different configurations.

Modules at software version 2.2.0 or later support SNMP (Simple Network Management Protocol) monitoring. For each applicable signal processing module, module, signal, and reference status are reported. For complete details on using SNMP monitoring, refer to the **Avenue System Overview** in the manual that accompanies each frame.

APPLICATIONS

Auto-Switched Protection Switch Application

The diagram below shows a typical use for the 4455 module, where it is used in conjunction with ASI sources to form a fully redundant, auto-switched conversion chain. The Primary input is backed up with a Secondary input from an alternate encoder.

Relay circuits accessible from the 15-pin D Control connector on the rear backplane can be connected to alarms for monitoring Primary and Secondary status and switch position.

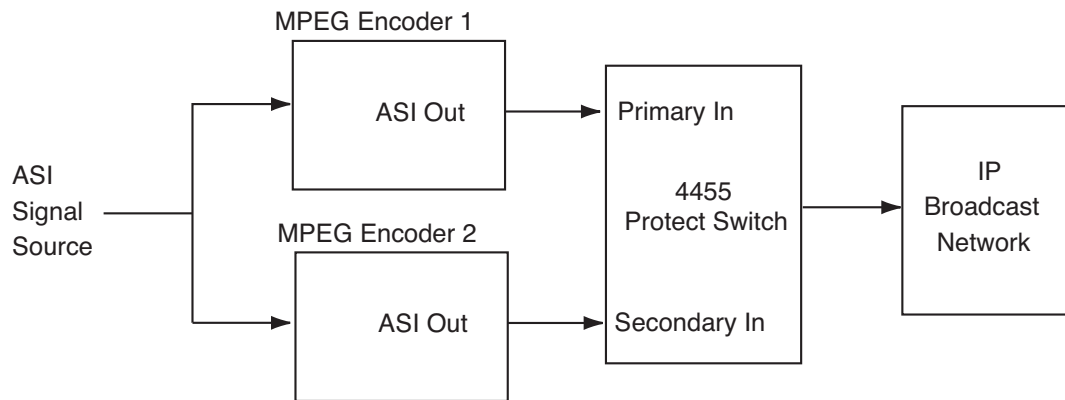

Redundant Auto-Switched Conversion With 4455 Module

Signal Decision Maker Application

In the example below, Point of View cameras in a sporting event output an ASI feed. The 4455 receives both signals, and based on the user-defined parameters, chooses the best of the signals for on-air use.

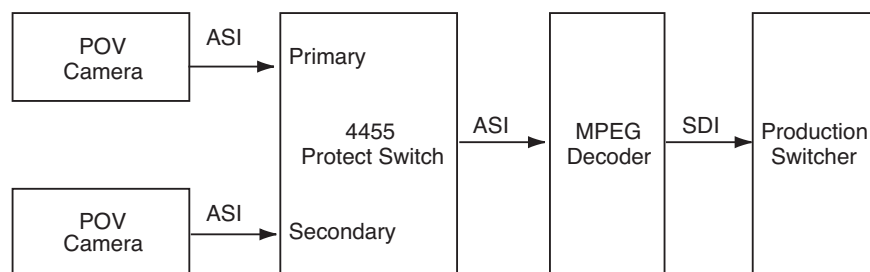

Signal Decision Maker With 4455 Module

INSTALLATION

Plug the 4455 module into any one of the slots in the 1RU or 3RU frame and install the plastic overlay provided onto the corresponding group of rear BNC connectors associated with the module location. Note that the plastic overlay has an optional adhesive backing for securing it to the frame. Use of the adhesive backing is only necessary if you would like the location to be permanent and is not recommended if you need to change module locations. This module may be hot-swapped (inserted or removed) without powering down or disturbing performance of the other modules in the system.

CABLING

Refer to the 3RU and 1RU backplane diagrams of the module on the following page for cabling instructions. Unless stated otherwise, the 1RU cabling explanations are identical to those given in the 3RU diagram.

3RU Backplane

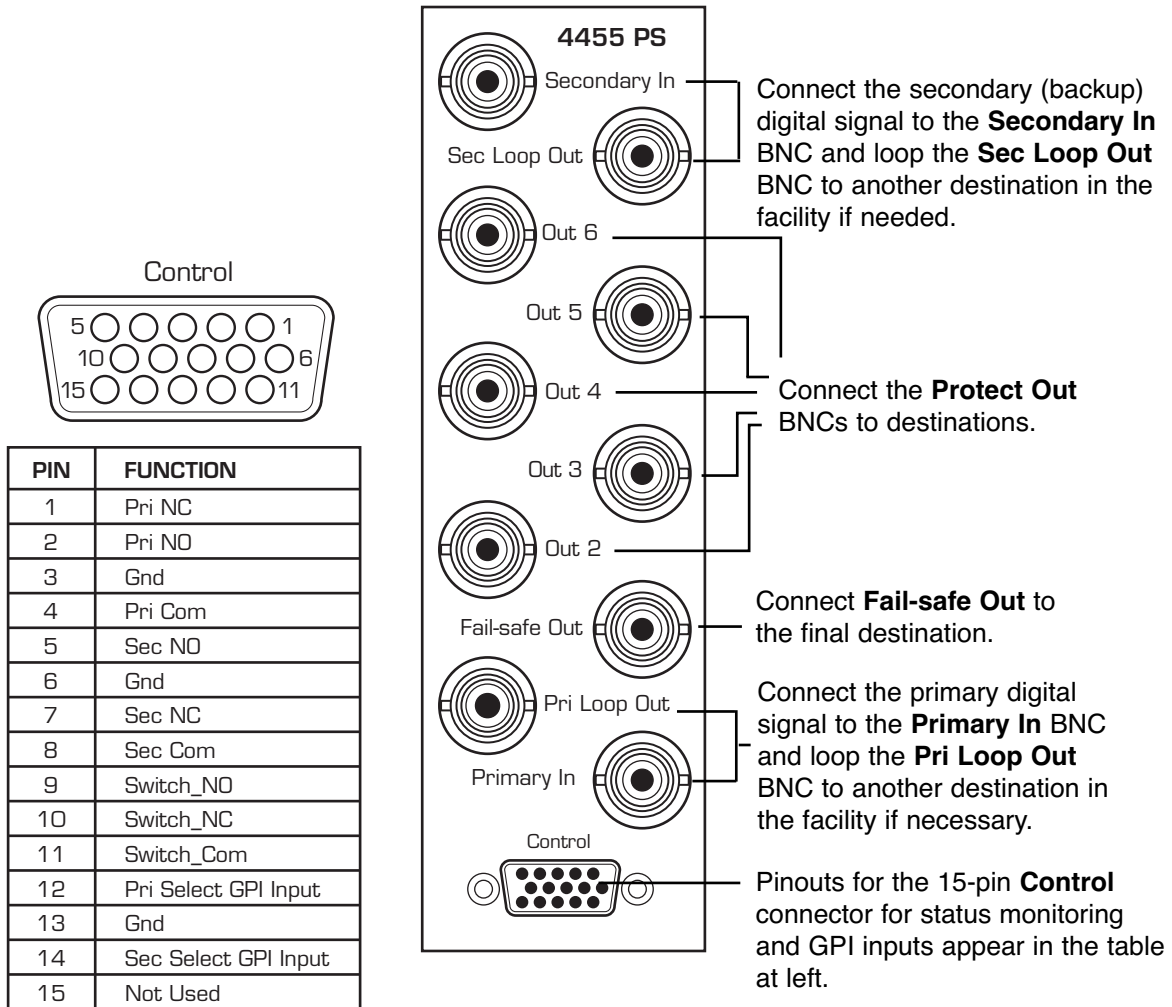

1RU Backplane

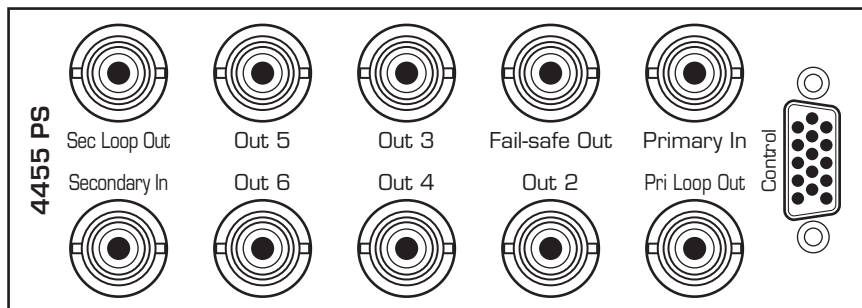

Status and Alarm Cabling

In addition to full monitoring and access through the control system, the 4455 module provides contact closure status indications through the 15-pin **D Control** connector on the corresponding rear slot of the frame. These connections can drive an alarm system or other external monitoring devices, including LEDs. Two override GPI Inputs can also be accessed through the connector. Pinouts for the status monitoring are given in the preceding illustration.

Form C relay contacts provide both NO (Normally Open) and NC (Normally Closed) switching to indicate fault status of the Primary and Secondary inputs and the protection switch output. Both the NO and NC contacts are simultaneously available on the **Control** connector. Each output is independently strappable to provide Ground, current limited +5V (1k resistor), or a Common which appears on the D connector.

The three relay contacts provide the following status reporting:

- **Primary Good or Failed** – indicates Primary input status as Good when NO contact is active (switched to Common)
- **Secondary Good or Failed** – indicates Secondary input status as Good when NO contact is active (switched to Common)
- **Switch Position** – indicates the position of the protect switch as either Primary or Secondary selected. The normal position corresponds to the Primary feeding the input

An individual common is provided to each of the relays. For each of the three status relays there is a 3-position jumper on the module which configures the common signal that will be used by that relay. The choices are as follows:

- **COM** – uses the user-provided common signal from the **Control** connector
- **+5** – provides a +5V signal through a 1k resistor to the relay common
- **Gnd** – uses ground as the relay common

Because both the NO and NC connections are provided, it is possible to have independent status lines for each of the two states of a status signal. For example, if the jumper is set to **+5V**, the Primary NO output will source +5V when the relay is in the normal position (Signal Failed) and the Primary NC output will source the +5V when the relay is closed (Signal Good). Additionally, in the case of selecting **+5V** as the common, the 1k resistor on the module will act as a current limiter, allowing the direct connection of ordinary LEDs to each of these output pins. A green LED could be connected to the NC output and a red LED to the NO output. This would provide complete and explicit indication to the operator as to the signal status.

Also available through the **Control** connector are two Override GPI inputs that when closed to ground, will force the switch to either Primary or Secondary. The GPI inputs are edge-triggered on a negative pulse, or simply a falling edge. These inputs may also be used to switch back to the Primary after a fault has cleared.

MODULE CONFIGURATION AND CONTROL

The configuration parameters for each Avenue module must be selected after installation. This can be done remotely using one of the Avenue remote control options or locally using the module front panel controls. Each module has a **REMOTE/LOCAL** switch on the front edge of the circuit board which must first be set to the desired control mode.

The configuration parameter choices for the module will differ between **Remote** and **Local** modes. In **Remote** mode, the choices are made through software and allow more selections. The **4455 Parameter Table** on the following page summarizes and compares the various configuration parameters that can be set remotely or locally and the default/factory settings. It also provides the default User Levels for each control. These levels can be changed using the Avenue PC application.

If you are not using a remote control option, the module parameters must be configured from the front panel switches. Parameters that have no front panel control will be set to a default value. The **Local** switches are illustrated in the **Front Panel Controls and Indicators** section following the **4455 Parameter Table**.

Avenue module parameters can be configured and controlled remotely from one or both of the remote control options, the Avenue Touch Screen or the Avenue PC Application. Once the module parameters have been set remotely, the information is stored on the module CPU. This allows the module be moved to a different cell in the frame at your discretion without losing the stored information. Remote configuration will override the switch settings on the front edge of the module.

For setting the parameters remotely using the Avenue PC option, refer to the **Avenue PC Remote Configuration** section of this document.

For setting the parameters remotely using the Avenue Touch Screen option, refer to the **Avenue Touch Screen Remote Configuration** section of this document.

4455 Parameter Table

CONTROL	LOCAL	REMOTE	DEFAULT	USER LEVEL
Auto Reset	On	On Off	On	Admin
Reset Time	15 seconds	0 - 60 seconds	15 seconds	Admin
ASI Test (PID switch for local control)	Switch 6: On Off	Off Simple Advanced	Simple	Admin
Sec Test Enable	On	On Off	On	Admin
Pri GPI Mode	Neg Edge Switch	Off Neg Edge Switch Ext Fault Low Ext Inhibit Low	Neg Edge Switch	Admin
Pgm Target	Any	Any Pgm 1 Pgm 2 Pgm 3 Pgm 4	Any	Admin
Target Select	None	1 to 32	1	Admin
Target Mode	None	On/Off	Off	Admin
PID Target	None	0 to 8191	0	Admin
Min Rate	None	0 to 10,000	0	Admin
ASI Time	2 sec	0.1 to 300 sec	2 sec	Admin
Min Vid Rate	100 PIDs	1 to 10,000 PIDs	100 PIDs	Admin
Min Aud Rate	20 PIDs	1 to 10,000 PIDs	20 PIDs	Admin
Memory Registers	Last Saved	1 – 5	Last Saved	Level 1

Front Panel Controls and Indicators

Each front edge indicator and switch setting of the 4455 is shown in the diagram below:

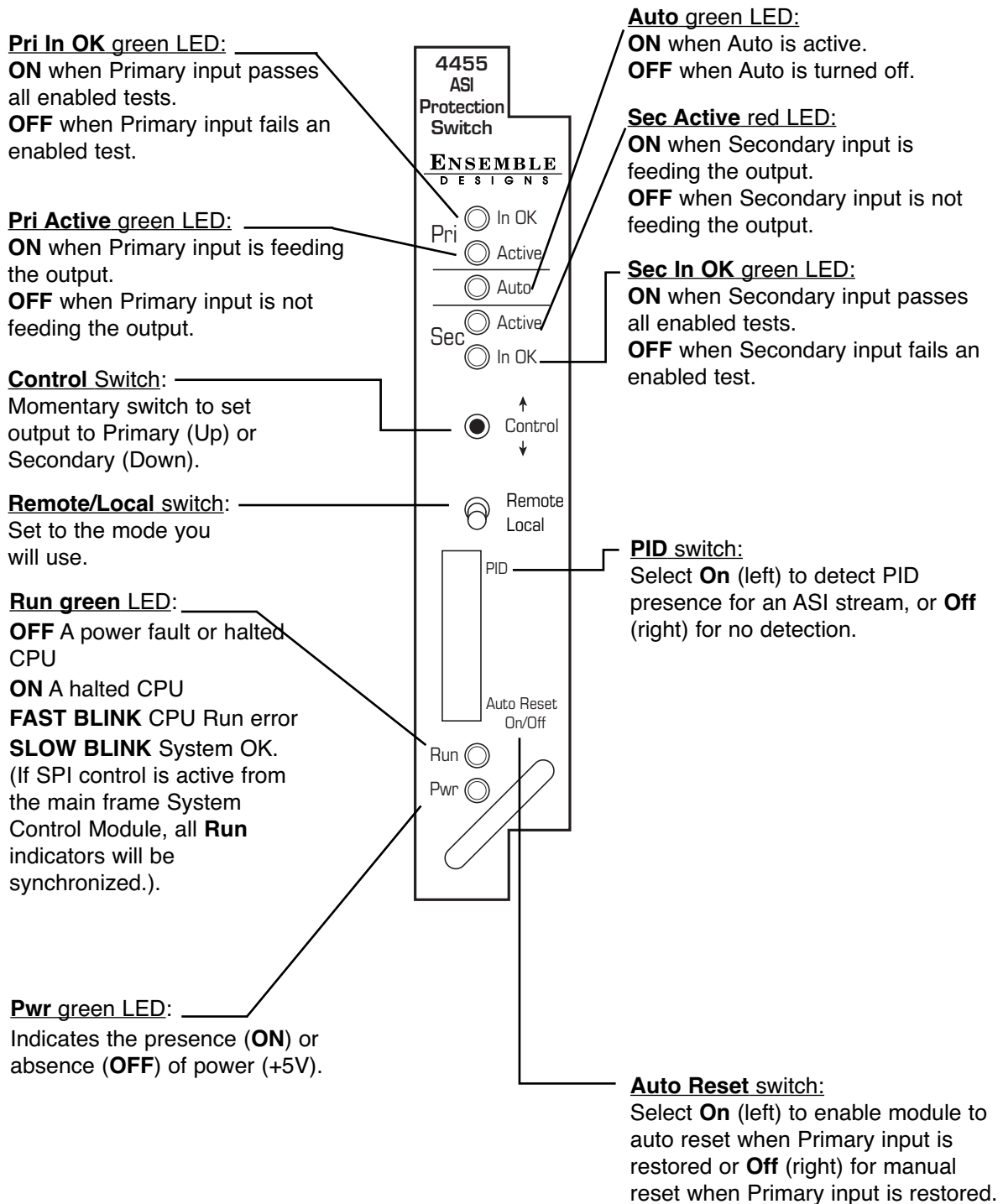

Avenue PC Remote Configuration

The Avenue PC remote control status menus for the 4455 module are illustrated and explained below. Refer to the **4455 Parameter Table** for a summary of available parameters that can be set remotely through the menus illustrated. For more information on using Avenue PC, refer to the Avenue PC Control Application Software data pack that came with the option.

Parameter fields that are grayed out can indicate one of the following conditions:

- An option is not installed.
- The function is not active.
- The module is locked.
- The User Level set with Avenue PC is not accessible from the current User Level.

4455 Avenue PC Menus

The **Status** menu screen shown below displays overall status of selected parameters on both the Primary and Secondary inputs as Green = Good, Red = Bad, Gray = Not enabled. It allows you to set the **Auto Reset** and **Reset Time** controls for the switching function.

- The **Pri Status** and **Sec Status** indicators show if an incoming DVB-ASI stream has been detected or not. Possible indications are:
 - **Good** – The ASI signal passes all tests (Simple, Program Specific or PID Specific)
 - **No ASI** – No ASI signal has been detected
 - **No Packets** - All of the packets in the stream are null. There are no actual program packets
 - **No PAT** - There are non-null packets, but no Program Allocation Table can be found
 - **No PMT** - No Program Management Table can be found
 - **No Video** - The user-defined minimum number of video packets per second has not been met
 - **No Audio** - The user-defined minimum number of audio packets per second has not been met

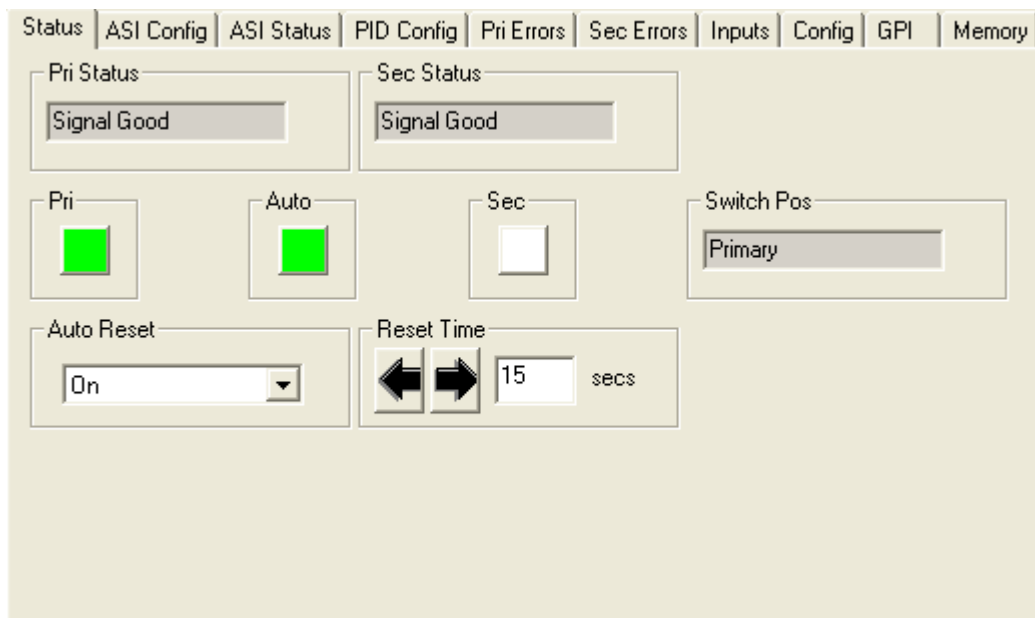

- **Pri** – lights green when the Primary input is selected to the output. Click this control to select the Primary as the output
- **Auto** – lights green when **Auto** is turned on. Switch **Auto** on and off with this switch control. When **Auto** is on, the module will automatically switch to the Secondary input if the Primary fails and the Secondary is good
- **Sec** – lights red when the Secondary input is selected to the output. Click this switch control to select the Secondary as the output
- **Switch Pos** – the status window will indicate the current position of the protect switch. This window can be monitored by the Avenue PC alarm function
- **Auto Reset** – set to **On** or **Off** to determine if the switch will automatically switch back to the Primary after it recovers
- **Reset Time** – set the amount of time the Primary signal must be good before the auto reset switches back to Primary from Secondary

The **ASI Config** menu shown below allows you to configure the following parameters:

- **Pgm Target** – looks for Program Management Tables in the ASI stream. Select **Any**, **Pgm 1**, **Pgm 2**, **Pgm 3**, or **Pgm 4**. When **Any** is selected, a PMT in any program stream will define the input as good.
- **ASI Time** – select the amount of time from 0.1 to 30 seconds that any enabled ASI errors are continuously detected before the protect switch (and alarm) is generated. When the program assignments in an ASI stream change, it can take up to a second for the 4455 detector to re-acquire all of the table information needed to show that the signal is good. For this reason, a setting of between 2 - 5 seconds is recommended.
- **Min Vid Rate** – set the video value from 1 to 10,000 video PIDs, below which the protect switch (and alarm) is generated.
- **Min Aud Rate** – set the audio value from 1 to 10,000 audio PIDs, below which the protect switch (and alarm) is generated.

The following status displays are also provided:

- **Pri ASI Status** – displays the status of the Primary and can be monitored with the Avenue PC alarm function.
- **Sec ASI Status** – displays the status of the Secondary and can be monitored with the Avenue PC alarm function.

The screenshot shows a software interface with a menu bar at the top containing the following items: Status, ASI Config, ASI Status, PID Config, Pri Errors, Sec Errors, Inputs, Config, GPI, and Memory. The 'ASI Config' menu is currently selected and active. Below the menu bar, the configuration options are displayed in a light beige background. The 'Pgm Target' is set to 'Any' in a dropdown menu. The 'ASI Time' is set to '2' seconds, with left and right arrow buttons for adjustment. The 'Min Vid Rate' is set to '100' PIDs, also with arrow buttons. The 'Min Aud Rate' is set to '20' PIDs, with arrow buttons. At the bottom, there are two status display boxes: 'Pri ASI Status' and 'Sec ASI Status', both showing the text 'ASI'.

The **ASI Status** menu shown below displays a breakdown of critical elements of analysis with a display of live results. The displayed values for the rate (in PIDs per second) for the video and audio can be used as a guide to setting the **Min Vid Rate** and **Min Aud Rate** values in the **ASI Config** menu for a particular system or installation. Additionally, the **ASI Status** menu shows the status of the following parameters:

- **Pri ASI Status** – displays the status of the Primary input and can be monitored with the Avenue PC alarm function
- **Sec ASI Status** – displays the status of the Secondary input and can be monitored with the Avenue PC alarm function
- **PAT per Sec** – displays the number of Program Allocation Tables detected per second for the Primary input
- **PMT per Sec** – displays the number of Program Management Tables detected per second for the Primary input
- **PCR per Sec** – displays the number of Program Clock References detected per second for the Primary input
- **Vid per Sec** – displays the number of video PIDs detected per second for the Primary input
- **Aud per Sec** – displays the number of audio PIDs detected per second for the Primary input
- **Packet Length** – displays the detected packet length per second for the Primary input

Status	ASI Config	ASI Status	PID Config	Pri Errors	Sec Errors	Inputs	Config	GPI	Memory
Pri ASI Status		Sec ASI Status							
Good		Good							
PAT per Sec		PMT per Sec		PCR per Sec					
0		0		0					
Vid per Sec		Aud per Sec		Packet Length					
0		0		None					









The **PID Config** menu is used for configuring the PID-specific targeting ability of the 4455. If you have chosen **PID Specific** from the **Config** menu's **ASI Test** pull-down menu, you are in PID Specific Mode. When in this mode, you can assign and configure up to 32 "PID Watchers" or "Targets," each tasked to monitor the data rate of their specific PID Target in an ASI signal. These are running in parallel, so there is no need to configure all 32 targets.

Using the **Target Select** control shown below, you can index through each of the 32 possible targets. Each target (or PID watcher) can be enabled or disabled and each one can be assigned a minimum packet rate. If any of the enabled watchers fails to collect its assigned data load a switch will be triggered.

There are 32 PID Targets. You can configure each PID Target using the following controls:

- **Target Select** – 1 to 32. Use one of the 32 Targets for each of the PIDs that you want to monitor (video or audio).
- **Target Mode** – With the desired Target selected, turn on Target Mode by selecting On from the Target Mode control.
- **PID Target** – Set the PID number for each PID Target you want to monitor.(0 to 8291).
- **Min Rate** – 0 to 10,000. Set the Minimum Packet Rate per second for each Target. The settings for the PID Targets will depend upon the data rate that the stream will contain.
- **Pri Actual Rate** – Reports the actual packet rate in the Primary signal stream.
- **Sec Actual Rate** – Reports the actual packet rate in the Secondary signal stream.
- **ASI Time** – Select the amount of time from 0.1 to 30 seconds that any PID Target errors are continuously detected before the protect switch (and alarm) is generated. A setting of between 2 - 5 seconds is recommended for most applications.
- **Pri Targ Status** – Reports the status of the selected Primary Target.
- **Sec Targ Status** – Reports the status of the selected Secondary Target.
- **Pri ASI Status** – Displays the status of the Primary and can be monitored with the Avenue PC alarm function.
- **Sec ASI Status** – Displays the status of the Secondary and can be monitored with the Avenue PC alarm function.

Model 4455 Serial Digital Protection Switch

Status	ASI Config	ASI Status	PID Config	Pri Errors	Sec Errors	Inputs	Config	GPI	Memory
Target Select		Target Mode		PID Target					
  1		On		  0					
Min Rate		Pri Actual Rate		Sec Actual Rate					
  0 PIDs		0 PIDs		0 PIDs					
ASI Time		Pri Targ Status		Sec Targ Status					
  2 secs		Good		Good					
		Pri ASI Status		Sec ASI Status					
		Good		Good					

Model 4455 Serial Digital Protection Switch

The **Pri Errors** and **Sec Errors** menus show error-seconds counters for all tests performed by the 4455. The error counters display the number of *cumulative* errors that have occurred since a counter was last reset. To reset the error-seconds counters, click them. Errors may occur as a single event, or as multiple events over a period of time. Refer to the Avenue PC manual to learn how to use the alarms and logging capabilities of Avenue PC to obtain more detailed information on errors.

The **Pri Errors** menu shown below displays the amount of time in seconds that each of the error conditions have been present after detection on the Primary feed.

The **ASI Vid ErrSec** control shows the cumulative number of seconds where the minimum video packet rate was not met. The **ASI Aud ErrSec** control shows the cumulative number of seconds where the minimum audio packet rate was not met. The **Sec Sw Cnt** control shows the number of times the switch has switched from the Primary feed to the Secondary feed.

Whenever the **ASI Test** generates a result other than **Good**, such as **No ASI**, or **No Packets**, a timer begins running. If that timer reaches the **ASI Time** value set in the **ASI Config** menu, the channel will be marked as faulted and the switch will move to the Secondary input.

The upper limit for cumulative errors is 10,000. If an error counter reaches this upper limit, it will repeatedly cycle between 10,000 and 9,999.

The screenshot shows the 'Pri Errors' menu with the following data:

Counter Name	Value	Unit
ASI ErrSec	668	Cnt
ASI Vid ErrSec	1	Cnt
ASI Aud ErrSec	1	Cnt
Sec Sw Cnt	0	Cnt

The **Sec Errors** menu shown below displays the amount of time in seconds that each of the enabled error conditions have been present after detection on the Secondary as well as the number of times the switch has switched from the Primary feed to the Secondary feed (**Sec Sw Cnt**).

The screenshot shows the 'Sec Errors' menu with the following data:

Counter Name	Value	Unit
ASI ErrSec	714	Cnt
ASI Vid ErrSec	1	Cnt
ASI Aud ErrSec	1	Cnt
Sec Sw Cnt	0	Cnt

The **Inputs** menu displays the type of signal detected on the Primary and Secondary inputs.

- **Primary Input** displays the signal type detected on the Primary Input connector, ASI or No Input.
- **Secondary Input** displays the signal type detected on the Secondary Input connector, ASI or No Input.

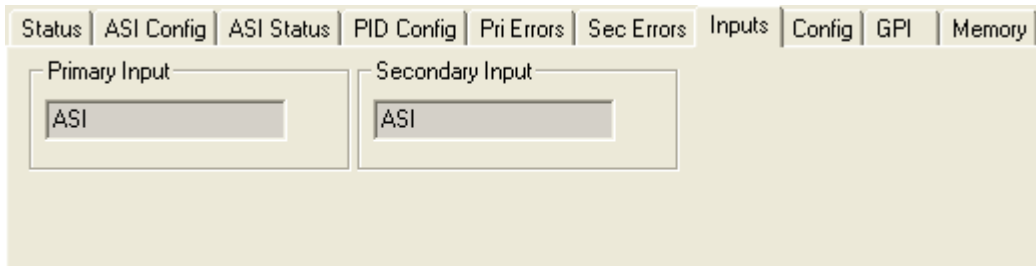

The **Config** menu shown below allows you to configure the various condition detectors.

- **ASI Test** – enables the test for an ASI signal. (Please see pages 2 and 3 for more information on what these selections mean.)
 - **Simple** detects ASI present as determined by the settings made in the **ASI Config** menu.
 - **Pgm Specific** detects the presence of at least one program stream being called for in the PAT.
 - **PID Specific** allows you to vet for up to 32 different target PIDs in an ASI signal.
 - **Off** sets the input for no ASI test.
- **Sec Test Enable** – enables the test for checking the status of the Secondary input. When **On**, the Secondary status will be checked for the same configuration tests as assigned for the Primary.

Whenever the **ASI Test** generates a result other than **Good**, such as **No ASI**, or **No Packets**, a timer begins running. If that timer reaches the **ASI Time** value set in the **ASI Config** menu, the channel will be marked as faulted and the switch will move to the Secondary input.

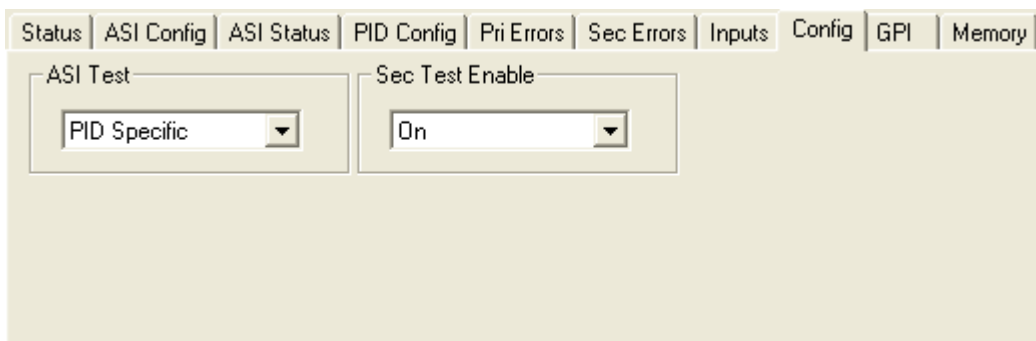

Model 4455 Serial Digital Protection Switch

The 4455 can be set up to allow an external device to trigger a switch through the GPI interface. The **GPI** menu screen shown below allows configuration of the two external GPI inputs to the module.

The Primary and Secondary GPI Modes can be set to one of the following:

- **Off** – disables the GPI input.
- **Neg Edge Switch** – switches on a low-going transition to the GPI input.
- **Ext Fault Low** – acts in conjunction with the status of the input signal to the module. In this case, a loss of proper signal to the module or a low signal detected from an external device will close the switch.
- **Ext Inhibit Low** – acts to prevent a switch regardless of the status of the input signal to the module. In this case, a loss of proper signal will not cause a switch.

Status of the Pri GPI and Sec GPI inputs are indicated as **GPI is Low** or **GPI is High** in the **Pri GPI** and **Sec GPI Status** window.

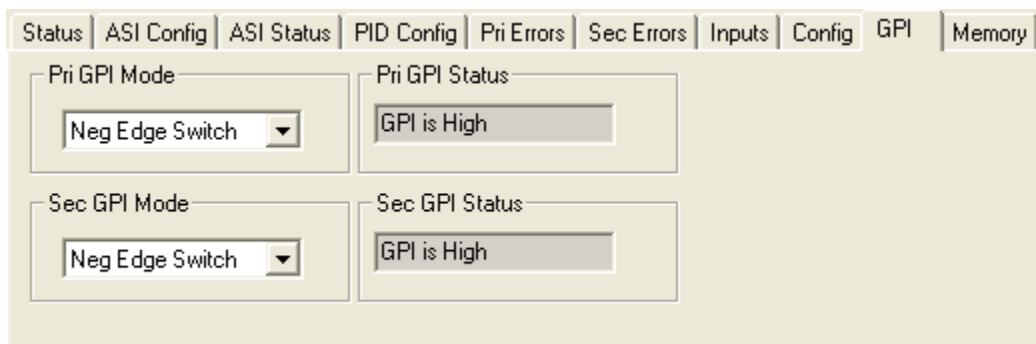

The **Memory** menu allows you to save and recall up to 5 different setups for the 4455 module as follows:

- Select **Save**, then one of the five memory registers **Reg 1 – 5**. The box will turn green. The entire module setup is now saved in the selected register.
- To recall a setup, select the register box. If there is information saved, the box will turn green. The saved setup will load into the module.

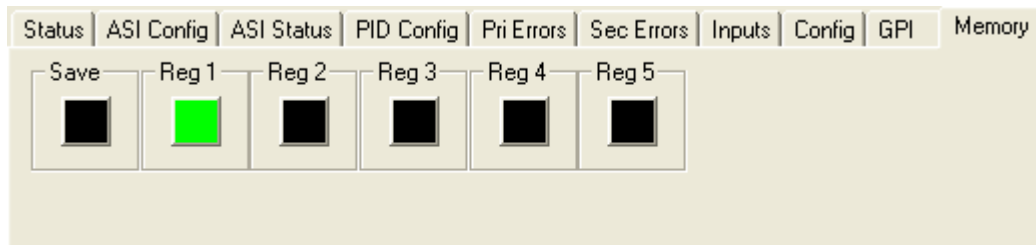

Avenue Touch Screen Remote Configuration

The Avenue Touch Screen remote control status menus for this module are illustrated and explained below. Refer to the **4455 Parameter Table** for a summary of available parameters that can be set remotely through the menus illustrated. For more information on using Avenue Touch Screen, refer to the Avenue Touch Screen data pack.

Parameter fields that are grayed out can indicate one of the following conditions:

- An option is not installed
- The function is not active
- The module is locked
- The User Level set with Avenue PC is not accessible from the current User Level

4455 Avenue Touch Screen Menus

The **Status** menu screen shown below displays overall status of selected parameters on both the Primary and Secondary inputs as Green = Good, Red = Bad, Gray = Not enabled. It allows you to set the **Auto Reset** and **Reset Time** controls for the switching function.

- The **Pri Status** and **Sec Status** indicators show if an incoming DVB-ASI stream has been detected or not. Possible indications are:
 - **Good** – The ASI signal passes all tests (either Simple or Advanced)
 - **No ASI** – No ASI signal has been detected
 - **No Packets** - All of the packets in the stream are null. There are no actual program packets
 - **No PAT** - There are non-null packets, but no Program Allocation Table can be found
 - **No PMT** - No Program Management Table can be found
 - **No Video** - The user-defined minimum number of video packets per second has not been met
 - **No Audio** - The user-defined minimum number of audio packets per second has not been met
- **Pri** – lights green when the Primary input is selected to the output. Click this control to select the Primary as the output
- **Auto** – lights green when **Auto** is turned on. Switch **Auto** on and off with this switch control. When **Auto** is on, the module will automatically switch to the Secondary input if the Primary fails and the Secondary is good
- **Sec** – lights red when the Secondary input is selected to the output. Click this switch control to select the Secondary as the output
- **Switch Pos** – the status window will indicate the current position of the protect switch. This window can be monitored by the Avenue PC alarm function
- **Auto Reset** – set to **On** or **Off** to determine if the switch will automatically switch back to the Primary after it recovers
- **Reset Time** – set the amount of time the Primary signal must be good before the auto reset switches back to Primary from Secondary

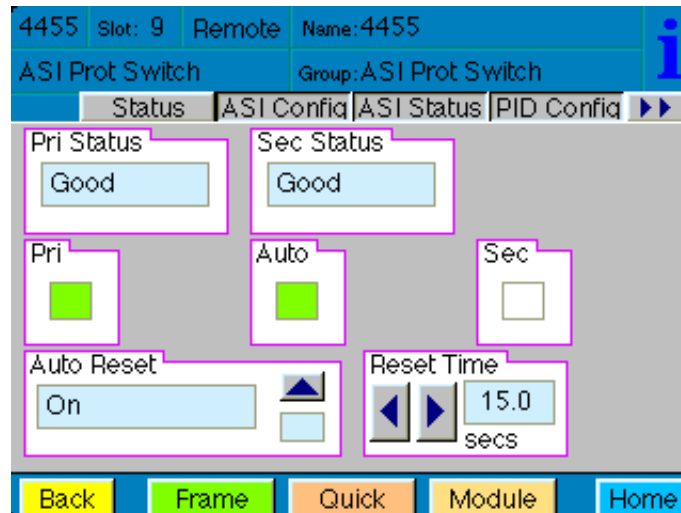

The **ASI Config** menu shown below allows you to configure the following parameters:

- **Pgm Target** – looks for Program Management Tables in the ASI stream. Select **Any**, **Pgm 1**, **Pgm 2**, **Pgm 3**, or **Pgm 4**. When **Any** is selected, a PMT in any program stream will define the input as good.
- **ASI Time** – select the amount of time from 0.1 to 30 seconds that any enabled ASI errors are continuously detected before the protect switch (and alarm) is generated. When the program assignments in an ASI stream change, it can take up to a second for the 4455 detector to re-acquire all of the table information needed to show that the signal is good. For this reason, a setting of between 2 - 5 seconds is recommended.
- **Min Vid Rate** – set the video value from 1 to 10,000 video PIDs, below which the protect switch (and alarm) is generated.
- **Min Aud Rate** – set the audio value from 1 to 10,000 audio PIDs, below which the protect switch (and alarm) is generated.

The following status displays are also provided:

- **Pri ASI Status** – displays the status of the Primary and can be monitored with the Avenue PC alarm function.
- **Sec ASI Status** – displays the status of the Secondary and can be monitored with the Avenue PC alarm function.

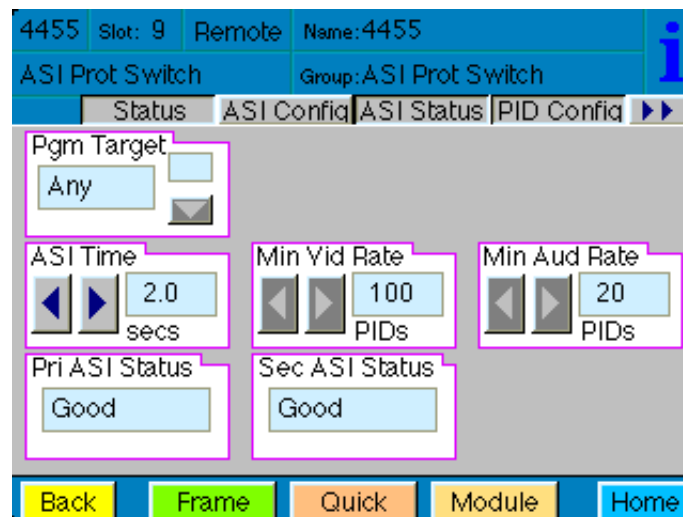

The **ASI Status** menu shown below displays a breakdown of critical elements of analysis with a display of live results. The displayed values for the rate (in PIDs per second) for the video and audio can be used as a guide to setting the **Min Vid Rate** and **Min Aud Rate** values in the **ASI Config** menu for a particular system or installation. Additionally, the **ASI Status** menu shows the status of the following parameters:

- **Pri ASI Status** – displays the status of the Primary input and can be monitored with the Avenue PC alarm function
- **Sec ASI Status** – displays the status of the Secondary input and can be monitored with the Avenue PC alarm function
- **PAT per Sec** – displays the number of Program Allocation Tables detected per second for the Primary input
- **PMT per Sec** – displays the number of Program Management Tables detected per second for the Primary input
- **PCR per Sec** – displays the number of Program Clock References detected per second for the Primary input
- **Vid per Sec** – displays the number of video PIDs detected per second for the Primary input
- **Aud per Sec** – displays the number of audio PIDs detected per second for the Primary input
- **Packet Length** – displays the detected packet length per second for the Primary input

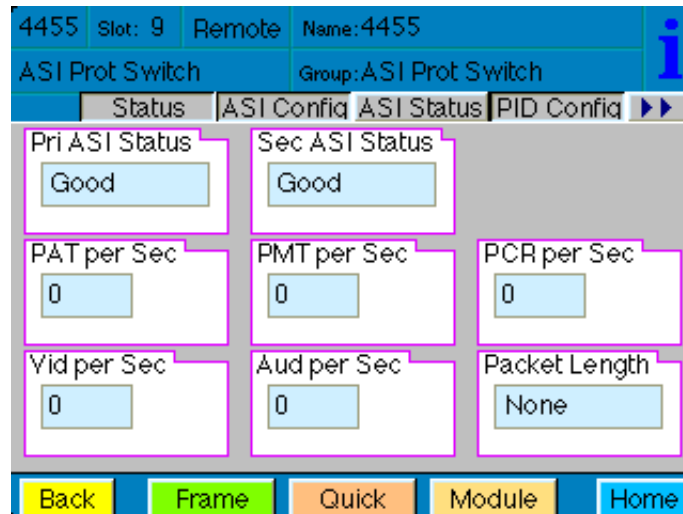

The **PID Config** menu is used for configuring the PID-specific targeting ability of the 4455. If you have chosen **PID Specific** from the **Config** menu's **ASI Test** pull-down menu, you are in PID Specific Mode. When in this mode, you can assign and configure up to 32 "PID Watchers" or "Targets," each tasked to monitor the data rate of their specific PID Target in an ASI signal. These are running in parallel, so there is no need to configure all 32 targets.

Using the **Target Select** control shown below, you can index through each of the 32 possible targets. Each target (or PID watcher) can be enabled or disabled and each one can be assigned a minimum packet rate. If any of the enabled watchers fails to collect its assigned data load a switch will be triggered.

There are 32 PID Targets. You can configure each PID Target using the following controls:

- **Target Select** – 1 to 32. Use one of the 32 Targets for each of the PIDs that you want to monitor (video or audio).
- **Target Mode** – With the desired Target selected, turn on Target Mode by selecting On from the Target Mode control.
- **PID Target** – Set the PID number for each PID Target you want to monitor.(0 to 8291).
- **Min Rate** – 0 to 10,000. Set the Minimum Packet Rate per second for each Target. The settings for the PID Targets will depend upon the data rate that the stream will contain.
- **Pri Actual Rate** – Reports the actual packet rate in the Primary signal stream.
- **Sec Actual Rate** – Reports the actual packet rate in the Secondary signal stream.
- **ASI Time** – Select the amount of time from 0.1 to 30 seconds that any PID Target errors are continuously detected before the protect switch (and alarm) is generated. A setting of between 2 - 5 seconds is recommended for most applications.
- **Pri Targ Status** – Reports the status of the selected Primary Target.
- **Sec Targ Status** – Reports the status of the selected Secondary Target.

4455	slot: 9	Remote	Name:4455	
ASI Prot Switch		Group:ASI Prot Switch		
Status	ASI Config	ASI Status	PID Config	▶▶
Target Select	Target Mode	PID Target		
<input type="text" value="1"/>	On <input type="checkbox"/>	<input type="text" value="0"/>		
Min Rate	Pri Actual Rate	Sec Actual Rate		
<input type="text" value="0"/> PIDs	<input type="text" value="0"/> PIDs	<input type="text" value="0"/> PIDs		
ASI Time	Pri Targ Status	Sec Targ Status		
<input type="text" value="2.0"/> secs	Good	Good		
Back	Frame	Quick	Module	Home

Model 4455 Serial Digital Protection Switch

The **Pri Errors** and **Sec Errors** menus show error-seconds counters for all tests performed by the 4455. The error counters display the number of *cumulative* errors that have occurred since a counter was last reset. To reset the error-seconds counters, click them. Errors may occur as a single event, or as multiple events over a period of time. Refer to the Avenue PC manual to learn how to use the alarms and logging capabilities of Avenue PC to obtain more detailed information on errors.

The **Pri Errors** menu shown below displays the amount of time in seconds that each of the error conditions have been present after detection on the Primary feed.

The **ASI Vid ErrSec** control shows the cumulative number of seconds where the minimum video packet rate was not met. The **ASI Aud ErrSec** control shows the cumulative number of seconds where the minimum audio packet rate was not met. The **Sec Sw Cnt** control shows the number of times the switch has switched from the Primary feed to the Secondary feed.

Whenever the **ASI Test** generates a result other than **Good**, such as **No ASI**, or **No Packets**, a timer begins running. If that timer reaches the **ASI Time** value set in the **ASI Config** menu, the channel will be marked as faulted and the switch will move to the Secondary input.

The upper limit for cumulative errors is 10,000. If an error counter reaches this upper limit, it will repeatedly cycle between 10,000 and 9,999.

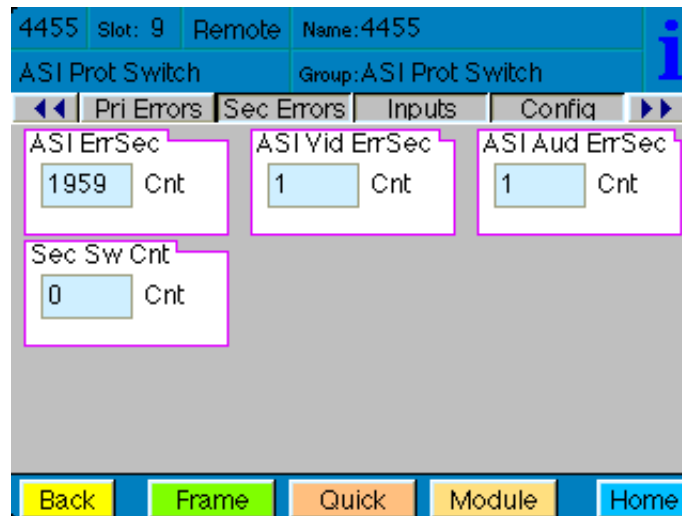

The **Sec Errors** menu shown below displays the amount of time in seconds that each of the enabled error conditions have been present after detection on the Secondary as well as the number of times the switch has switched from the Primary feed to the Secondary feed (**Sec Sw Cnt**).

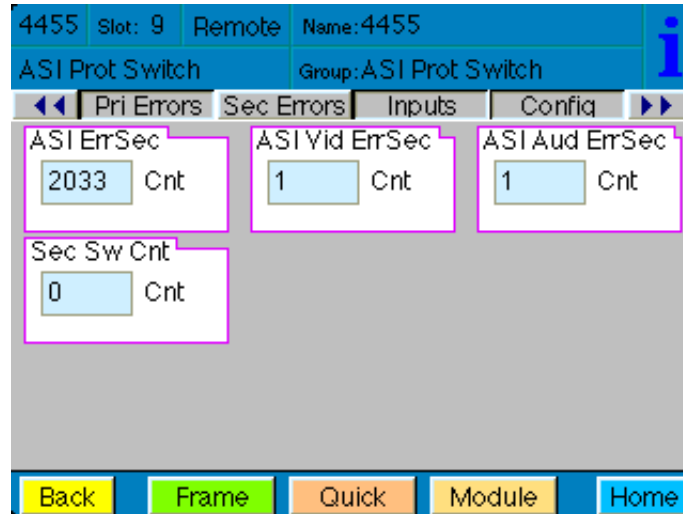

The **Inputs** menu displays the type of signal detected on the Primary and Secondary inputs.

- **Primary Input** displays the signal type detected on the Primary Input connector, ASI or No Input.
- **Secondary Input** displays the signal type detected on the Secondary Input connector, ASI or No Input.

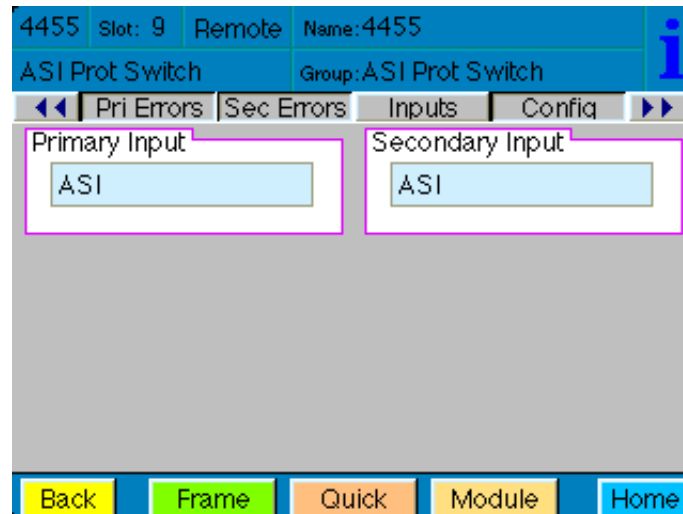

Model 4455 Serial Digital Protection Switch

The **Config** menu shown below allows you to configure the various condition detectors.

- **ASI Test** – enables the test for an ASI signal. (Please see pages 2 and 3 for more information on what these selections mean.)
 - **Simple** detects ASI present as determined by the settings made in the **ASI Config** menu.
 - **Pgm Specific** detects the presence of at least one program stream being called for in the PAT.
 - **PID Specific** allows you to vet for up to 32 different target PIDs in an ASI signal.
 - **Off** sets the input for no ASI test.
- **Sec Test Enable** – enables the test for checking the status of the Secondary input. When **On**, the Secondary status will be checked for the same configuration tests as assigned for the Primary.

Whenever the **ASI Test** generates a result other than **Good**, such as **No ASI**, or **No Packets**, a timer begins running. If that timer reaches the **ASI Time** value set in the **ASI Config** menu, the channel will be marked as faulted and the switch will move to the Secondary input.

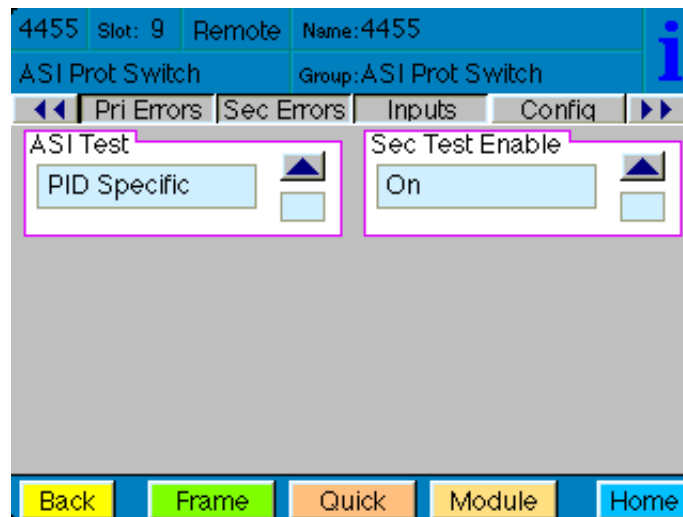

Model 4455 Serial Digital Protection Switch

The 4455 can be set up to allow an external device to trigger a switch through the GPI interface. The **GPI** menu screen shown below allows configuration of the two external GPI inputs to the module.

The Primary and Secondary GPI Modes can be set to one of the following:

- **Off** – disables the GPI input.
- **Neg Edge Switch** – switches on a low-going transition to the GPI input.
- **Ext Fault Low** – acts in conjunction with the status of the input signal to the module. In this case, a loss of proper signal to the module or a low signal detected from an external device will close the switch.
- **Ext Inhibit Low** – acts to prevent a switch regardless of the status of the input signal to the module. In this case, a loss of proper signal will not cause a switch.

Status of the Pri GPI and Sec GPI inputs are indicated as **GPI is Low** or **GPI is High** in the **Pri GPI** and **Sec GPI Status** window.

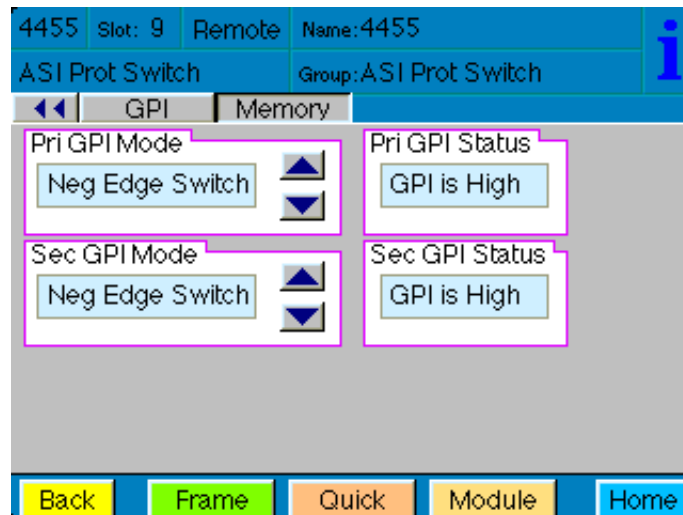

Model 4455 Serial Digital Protection Switch

The **Memory** menu allows you to save and recall up to 5 different setups for the 4455 module as follows:

- Select **Save**, then one of the five memory registers **Reg 1 – 5**. The box will turn green. The entire module setup is now saved in the selected register.
- To recall a setup, select the register box. If there is information saved, the box will turn green. The saved setup will load into the module.

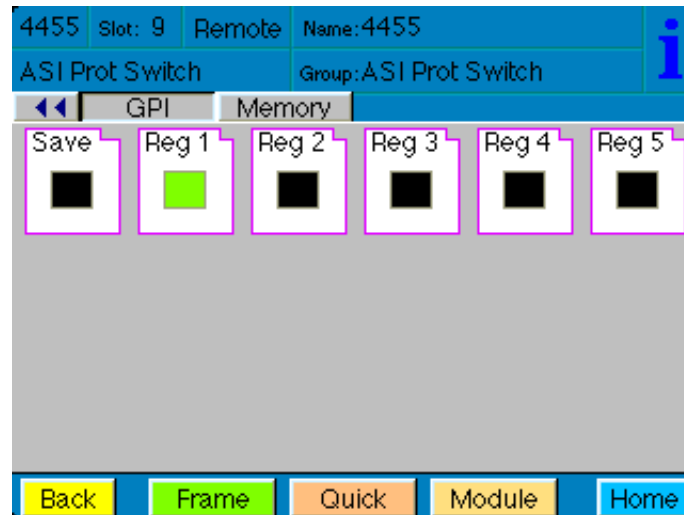

TROUBLESHOOTING

As a troubleshooting aid, reference signal status and presence, as well as power and CPU status can be easily monitored from the front panel of the 4455 module using the front panel indicators.

Refer to the troubleshooting tips below:

Can't control module:

- Check status of CPU **Run** green LED. Should be blinking slowly and in unison with other modules if System module is present. If not, try removing it and plugging it in again to be sure it is seated properly.
- System module may not be working properly if installed.

Module remote controls are grayed out:

- Module is locked or access to module controls is restricted by User Level.

No signal out of module:

- Check status of **Active** LEDs. Primary or Secondary should be lit. If not, check the inputs for signal presence and quality.
- Check cabling to input of the module.

Input says “No Input”:

- Be sure a DVB-ASI signal is connected to the input. This module does not support SD SDI or HD SDI signals (use 7460 module)

Please also refer to the technical support section of the Ensemble Designs web site for the latest information on your equipment at the URL below:

<http://www.ensembledesigns.com/support>

SOFTWARE UPDATES

Software updates for each module can be downloaded remotely if the optional System Control module is installed. These can be downloaded onto your PC, then Avenue PC will distribute the update to the individual module. (Refer to the Avenue PC documentation for more information) Updates are periodically posted on the Ensemble Designs web site. If you do not have the required System Control Module and Avenue PC, modules can be sent back to the factory for software upgrades.

WARRANTY AND FACTORY SERVICE

Warranty

This module is covered by a five year limited warranty, as stated in the main Preface of this manual. If you require service (under warranty or not), please contact Ensemble Designs and ask for customer service before you return the unit. This will allow the service technician to provide any other suggestions for identifying the problem and recommend possible solutions.

Factory Service

If you return equipment for repair, please get a Return Material Authorization Number (RMA) from the factory first.

Ship the product and a written description of the problem to:

Ensemble Designs, Inc.

Attention: Customer Service RMA #####

870 Gold Flat Rd.

Nevada City, CA. 95959 USA

(530) 478-1830

Fax: (530) 478-1832

service@ensembledesigns.com

<http://www.ensembledesigns.com>

Be sure to put your RMA number on the outside of the box.

SPECIFICATIONS

4455 ASI Protection Switch

Input Signal:

Number: Two
Signal Type: DVB-ASI at 270 Mb/s

Loopback:

Number: Two total
One primary
One secondary
Impedance: 75 Ω

Output Signal:

Number: Six total
One fail-safe bypass output
Five outputs

Signal Type: DVB-ASI
Impedance: 75 Ω

General Specifications:

Power Consumption: < 7.0 watts
Temperature Range: 0 to 40 degrees C ambient
(all specs met)
Relative Humidity: 0 to 95% noncondensing
Altitude: 0 to 10,000 ft
Fusing: 4 each 0.75 Amp PTC resettable fuse with
each domain of the module independently regulated.

Due to ongoing product development, all specifications subject to change.