

# Model 7460 HD/SD/ASI Serial Digital Protection Switch Data Pack

**ENSEMBLE**

D E S I G N S

Revision 1.3 SW v2.2.00

This data pack provides detailed installation, configuration and operation information for the **7460 HD/SD/ASI Serial Digital Protection Switch** module as part of the Avenue Signal Integration System.

The module information in this data pack is organized into the following sections:

- Module Overview
- Applications
- Installation
- Cabling
- Module Configuration and Control
  - Front Panel Controls and Indicators
  - Avenue PC Remote Control
  - Avenue Touch Screen Remote Control
- Troubleshooting
- Software Updating
- Warranty and Factory Service
- Specifications

### MODULE OVERVIEW

The 7460 Serial Digital Protection Switch module is a fail-safe protection switch for monitoring and switching critical digital paths for broadcast or satellite applications.

The 7460 supports SD-SDI, HD-SDI, and DVB-ASI signals. Different types of signal testing (vetting) can be enabled on the 7460 and it will apply the tests according to the type of input that is present. This happens automatically and independently for the Primary and Secondary inputs. This means that the Primary input of the module could be HD-SDI while the Secondary input is SD-SDI. It is also possible to mix SDI and DVB-ASI signals, or receive the same standard on both the Primary and Secondary inputs.

When a fault is detected in the Primary input and the Secondary input is verified as good, the switch will activate, causing the Secondary input to be switched to the module's output. The 7460 includes a fail-safe bypass which connects the Primary input directly to one of the 6 module outputs. This passive, fail-safe path ensures that there is an output even in the event of a total power failure.

The 7460 can operate in two modes: automatic or non-resetting. In fully automatic mode, the 7460 will automatically switch back to the Primary signal once it has been restored. In non-resetting mode, the Secondary input remains routed to the output even after the Primary input has recovered. In this case, manual intervention is needed to throw the switch back to the Primary input. With Auto mode turned off, a fault in the Primary signal will generate an alarm but no switching will occur.

### SDI SIGNAL EVALUATION

The 7460 monitors the integrity of the serial digital input stream and analyzes its audio and video content. Signal health and fault detection of SD-SDI and HD-SDI signals is determined by monitoring any or all of the following parameters, in order of increasing complexity:

- **Timing Reference Signal (TRS)** – This parameter checks for the persistent loss of digital sync by looking for the correct Timing Reference Signal carried in the serial video stream. When this digital sync format is correct, the signal is considered good.
- **Black** – Black detection is based on three configurable parameters: black level threshold, black pixel count, and black duration time. All of these parameters can be set using the menu system to meet the needs of specific video signal inputs.
- **Embedded Audio** – This parameter will look for correctly configured embedded audio packets in the horizontal intervals of the signals. The actual audio content of the packets is further analyzed to detect silence. Specific audio parameters, such as audio group, silence threshold level, and audio silence duration can be configured in the Avenue PC and Touch Screen menus.
- **Freeze** – This parameter checks for a freeze condition as determined by the settings selected in the **Freeze** menu.

A sophisticated black detection system is employed to activate the switch in the event signal is lost. It allows the user to select not only the threshold and percentage of non-black pixels, but also the portion of the picture to be considered. The area of the picture checked is determined by selecting **Small Window** which is approximately two thirds of the picture width and height, or **Big Window** which covers approximately 90% of the

width and height. This allows a corner Bug to be either excluded or included in the detection process.

Black detection is performed on a pixel-by-pixel basis within the selected window, with user selectable **Detect Level** and **Blk Frac** adjustments. Pixels above the **Detect Level** are considered as being non-black. **Blk Frac** sets the percentage of pixels which must be non-black. If **Detect Level** is set to 12 IRE and **Blk Frac** is set to 10% then the 7460 expects there to be pixel levels above 12 IRE for more than 10% of each frame. For example, if **Blk Time** is set to 3 seconds, if less than 10% of the pixels in each frame are above the selected 12 IRE level for a period of 3 seconds, a switch will occur.

**Pri Valid** and **Sec Valid** are dynamic values based on incoming video. In the above example, if **Pri Valid** fell below **Blk Frac** continuously for 3 seconds there would be a switch, provided that there is valid secondary video. Note however, that the display may not keep pace with short duration transitions of actual video. In the example, a blip above 12 IRE for a single frame every 2 seconds would prevent a switch from taking place, since the 3 second count would be reinitialized by these valid frames.

### ASI SIGNAL EVALUATION

For DVB-ASI signals, there are two levels of signal analysis available: **Simple** or **Advanced**. Use the **ASI Test** control in the **Config** menu to choose between these.

When **ASI Test** is set to **Simple**, the 7460 looks for:

- Input signal presence and digital clock lock
- Presence of non-null (blank) packets
- Presence of Program Allocation Table (PAT) PIDs occurring at least two per second

When **ASI Test** is set to **Advanced**, the 7460 looks for the above conditions, plus the following:

- The presence of at least one program stream being called for in the PAT. The 7460 can automatically look for the first one, or the user can tell it which of the first four it should look for. This selection is made with the **Pgm Target** control in the **ASI Config** menu. The 7460 expects at least 1 Program Management Table (PMT) PID per second.
- The targeted Program must contain at least one elementary Video Stream and one elementary Audio Stream.
- A user-defined minimum number of video packets each second in the Video PID.
- A user-defined minimum number of audio packets each second in the Audio PID.

The **Pri ASI Status** and **Sec ASI Status** indicators show what has been detected in the incoming DVB-ASI stream.

Possible indications are:

- **Good** – The DVB-ASI signals passes all tests (either Simple or Advanced)
- **No ASI** – No DVB-ASI signal has been detected
- **No Packets** - All of the packets in the stream are null. There are no actual program packets

- **No PAT** - There are non-null packets, but no Program Allocation Table can be found
- **No PMT** - No Program Management Table can be found
- **No Video** - The user-defined minimum number of video packets per second has not been met
- **No Audio** - The user-defined minimum number of audio packets per second has not been met

The **ASI Status** menu shows a breakdown of these elements of analysis with a display of live results. The displayed values for the rate (in PIDs per second) for the video and audio can be used as a guide to setting the **Min Vid Rate** and **Min Aud Rate** values for a particular system or installation.

Whenever the DVB-ASI test generates a result other than **Good**, a timer begins running. If that timer reaches the **ASI Time** value set in the **ASI Config** menu, the channel will be marked as faulted and the switch will move to the Secondary input.

When the program assignments in a DVB-ASI stream change, it can take up to a second for the 7460 detector to re-acquire all of the table information needed to show that the signal is good. For this reason, a setting of between 2 - 5 seconds is recommended for the **ASI Time** parameter.

The **Pri Errors** and **Sec Errors** menus show error-seconds counters for all tests performed by the 7460. The **ASI Vid ErrSec** control shows the cumulative number of seconds where the minimum packet rate was not met. Depending on how the **ASI Time** control is set, these errors may or may not have actually caused a program switch to occur. To reset the error-seconds counters, click them.

## Model 7460 Serial Digital Protection Switch

The block diagram below illustrates the signal flow of the 7460. Note that in the event of power failure, the passive relay passes the primary input to the Relay Protected Output.

The Primary and Secondary inputs pass through serial digital receiver/equalizers for buffering. When a fault is detected in the Primary input, and the Secondary input is seen as not faulted, the electronic solid state switch will activate, switching the Secondary input to the output.

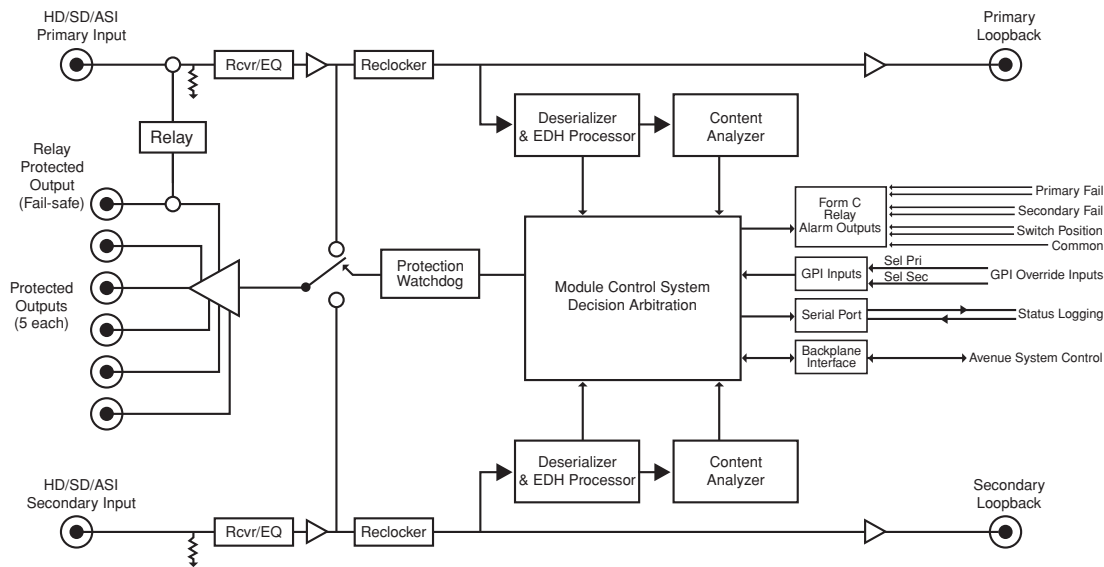

### 7460 Serial Digital Protection Switch

Each of the signals is fed to identical detection circuits which evaluate multiple parameters and characteristics of the signal in order to arrive at a fault decision. Detection of TRS errors is done in a Receiver/Reclocker circuit which produces a reclocked serial output feeding a Deserializer circuit. The output of this section then feeds a Field Programmable Gate Array (FPGA) where the signals are vetted, or tested for configured parameters. The Signal Vetter™ process in the FPGA detects the parameters chosen by the user using either the front panel controls or through the Avenue PC or Touch Screen menus. Each of the chosen aspects are monitored independently, and when they fail to meet the vetted standard, a fault condition is issued.

Fault conditions can be monitored with an external alarm system or other device through the 15-pin **Control** connector on the corresponding rear backplane connector. The Form C relays status outputs from this connector can be monitored by a device to show Primary and Secondary signal status and the current position of the protect switch (Primary or Secondary).

Two GPI Override Inputs are available to allow changing switch position in response to triggers from an external source. This can be used to manually reset the switch after the Primary has recovered from a fault condition or set to respond to a signal state from an external device to trigger a switch.

The on-board CPU can monitor and report module ID information (slot location, software version and board revision), and power status to the optional frame System Control

module. This information can be accessed by the user or set to register an alarm if desired using the remote control options available.

Every function and parameter on the module can be controlled from an Avenue Touch Screen Control Panel or the Avenue PC Control Application. Memory registers can be used to save the complete configuration of the module, making it easy to change instantly between different configurations.

Modules at software version 2.2.0 or later support SNMP (Simple Network Management Protocol) monitoring. For each applicable signal processing module, module, signal, and reference status are reported. For complete details on using SNMP monitoring, refer to the **Avenue System Overview** in the manual that accompanies each frame.

## APPLICATIONS

### Auto-Switched Upconversion Application

The diagram below shows a typical use for the 7460 module, where it is used in conjunction with the 7900 Up/Down Cross Converter module to form a fully redundant, auto-switched conversion chain. The Primary input is backed up with a Secondary input from a video server.

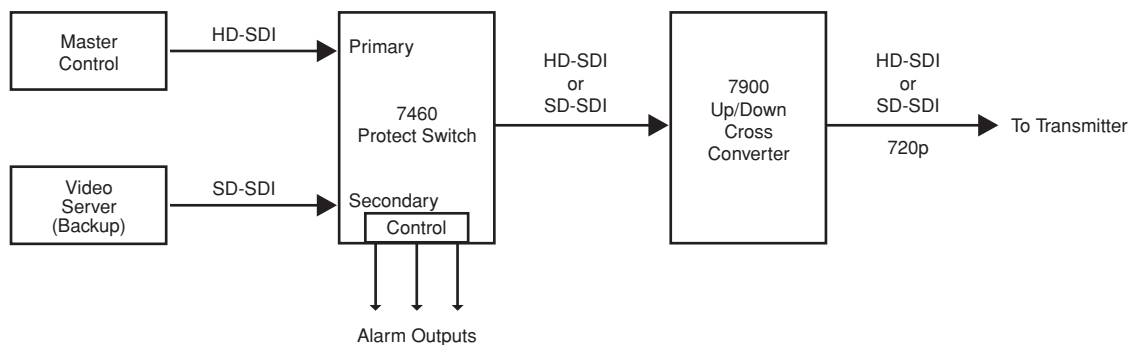

**Redundant Auto-Switched Conversion With 7460 Module**

The 7460 Protect Switch can accept different types of signals on its two inputs. The 7460 auto-senses and reports what type of signal it is receiving: HD-SDI, SD-SDI, or ASI.

Here, an HD-SDI signal is fed to the Primary input while an SD-SDI signal is fed to the Secondary input. If the HD-SDI signal is bad, and the 7460 switches to the SD-SDI signal, SD-SDI will be output.

The 7900 Up/Down Cross Converter shown above accepts an SD-SDI or HD-SDI signal. The user sets the 7900 to the desired output type. In this example, the 7900 is set to output HD 720p. If the incoming signal is 720p, the signal simply passes to the output. If the incoming signal is 1080i, the 7900 cross-converts the signal and outputs 720p. If the incoming signal is SD-SDI, the 7900 upconverts the signal and outputs HD 720p.

Relay circuits accessible from the 15-pin D Control connector on the rear backplane can be connected to alarms for monitoring Primary and Secondary status and switch position.

### Fiber Feed Application

In the example below, a fiber feed goes to an Avenue 3720 optical-to-electrical converter and into the 7460. The 7460 evaluates the HD-SDI signal health of both feeds and switches to the Secondary feed if required.

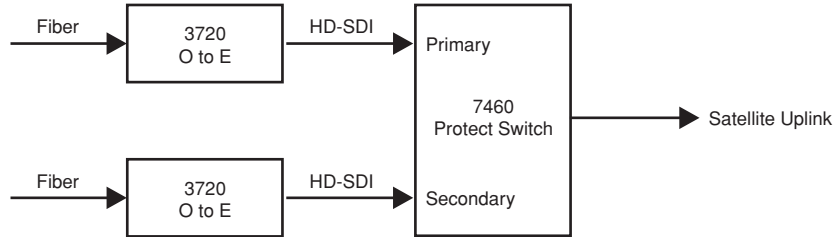

**Fiber Feed With 7460 Module**

### Signal Decision Maker Application

In the example below, Point of View cameras in a sporting event output an ASI feed. The 7460 receives both signals, and based on the user-defined parameters, chooses the best of the signals for on-air use.

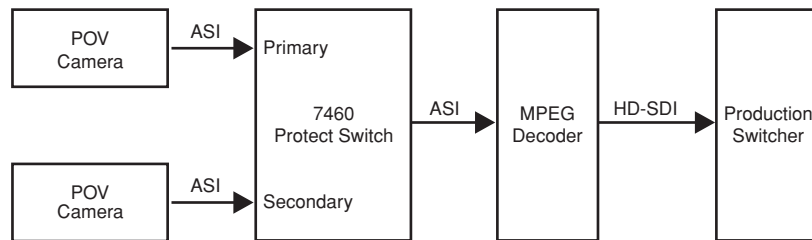

**Signal Decision Maker With 7460 Module**

3 RU Backplane

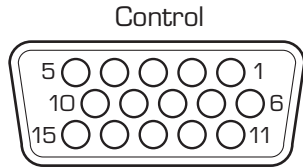

PIN	FUNCTION
1	Pri NC
2	Pri NO
3	Gnd
4	Pri Com
5	Sec NO
6	Gnd
7	Sec NC
8	Sec Com
9	Switch_NO
10	Switch_NC
11	Switch_Com
12	Pri Select GPI Input
13	Gnd
14	Sec Select GPI Input
15	Not Used

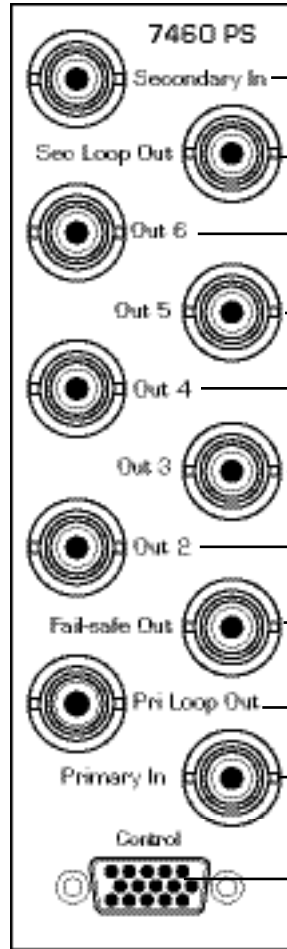

Connect the secondary (backup) digital signal to the **Secondary In** BNC and loop the **Sec Loop Out** BNC to another destination in the facility if needed.

Connect the **Protect Out** BNCs to destinations.

Connect **Fail-safe Out** to the final destination.

Connect the primary digital signal to the **Primary In** BNC and loop the **Pri Loop Out** BNC to another destination in the facility if necessary.

Pinouts for the 15-pin **Control** connector for status monitoring and GPI inputs appear in the table at left.

1 RU Backplane

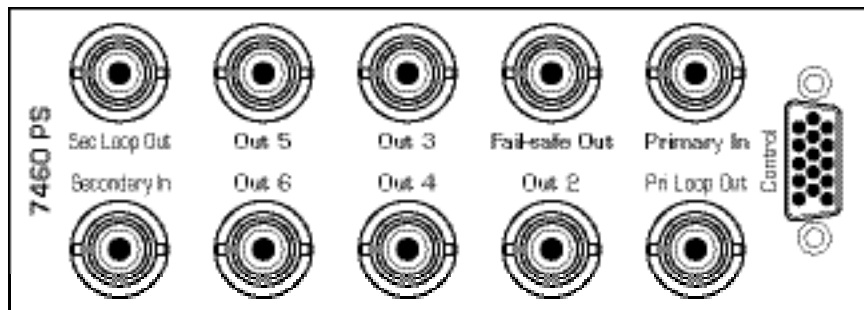

### Status and Alarm Cabling

In addition to full monitoring and access through the control system, the 7460 module provides contact closure status indications through the 15-pin D **Control** connector on the corresponding rear slot of the frame. These connections can drive an alarm system or other external monitoring devices, including LEDs. Two override GPI Inputs can also be accessed through the connector. Pinouts for the status monitoring are given in the preceding illustration.

Form C relay contacts provide both NO (Normally Open) and NC (Normally Closed) switching to indicate fault status of the Primary and Secondary inputs and the protection switch output. Both the NO and NC contacts are simultaneously available on the **Control** connector. Each output is independently strappable to provide Ground, current limited +5V (1k resistor), or a Common which appears on the D connector.

The three relay contacts provide the following status reporting:

- **Primary Good or Failed** – indicates Primary input status as Good when NO contact is active (switched to Common).
- **Secondary Good or Failed** – indicates Secondary input status as Good when NO contact is active (switched to Common).
- **Switch Position** – indicates the position of the protect switch as either Primary or Secondary selected. The normal position corresponds to the Primary feeding the input.

An individual common is provided to each of the relays. For each of the three status relays there is a 3-position jumper on the module which configures the common signal that will be used by that relay. The choices are as follows:

- **COM** – uses the user-provided common signal from the **Control** connector.
- **+5** – provides a +5V signal through a 1k resistor to the relay common.
- **Gnd** – uses ground as the relay common.

Because both the NO and NC connections are provided, it is possible to have independent status lines for each of the two states of a status signal. For example, if the jumper is set to **+5V**, the Primary NO output will source +5V when the relay is in the normal position (Signal Failed) and the Primary NC output will source the +5V when the relay is closed (Signal Good). Additionally, in the case of selecting **+5V** as the common, the 1k resistor on the module will act as a current limiter, allowing the direct connection of ordinary LEDs to each of these output pins. A green LED could be connected to the NC output and a red LED to the NO output. This would provide complete and explicit indication to the operator as to the signal status.

Also available through the **Control** connector are two Override GPI inputs that when closed to ground, will force the switch to either Primary or Secondary. The GPI inputs are edge-triggered on a negative pulse, or simply a falling edge. These inputs may also be used to switch back to the Primary after a fault has cleared.

## MODULE CONFIGURATION AND CONTROL

The configuration parameters for each Avenue module must be selected after installation. This can be done remotely using one of the Avenue remote control options or locally using the module front panel controls. Each module has a **REMOTE/LOCAL** switch on the front edge of the circuit board which must first be set to the desired control mode.

The configuration parameter choices for the module will differ between **Remote** and **Local** modes. In **Remote** mode, the choices are made through software and allow more selections. The **7460 Parameter Table** on the following page summarizes and compares the various configuration parameters that can be set remotely or locally and the default/factory settings. It also provides the default User Levels for each control. These levels can be changed using the Avenue PC application.

If you are not using a remote control option, the module parameters must be configured from the front panel switches. Parameters that have no front panel control will be set to a default value. The **Local** switches are illustrated in the **Front Panel Controls and Indicators** section following the **7460 Parameter Table**.

Avenue module parameters can be configured and controlled remotely from one or both of the remote control options, the Avenue Touch Screen or the Avenue PC Application. Once the module parameters have been set remotely, the information is stored on the module CPU. This allows the module be moved to a different cell in the frame at your discretion without losing the stored information. Remote configuration will override the switch settings on the front edge of the module.

For setting the parameters remotely using the Avenue PC option, refer to the **Avenue PC Remote Configuration** section of this document.

For setting the parameters remotely using the Avenue Touch Screen option, refer to the **Avenue Touch Screen Remote Configuration** section of this document.

**Model 7460 Serial Digital Protection Switch**
**7460 Parameter Table**

<b>CONTROL</b>	<b>LOCAL</b>	<b>REMOTE</b>	<b>DEFAULT</b>	<b>USER LEVEL</b>
<b>Auto Reset</b>	On	On Off	On	Admin
<b>Reset Time</b>	15 seconds	0 - 60 seconds	15 seconds	Admin
<b>TRS Test</b>	Switch 1: On Off	Off Lenient Strict	Lenient	Admin
<b>ASI Test</b> (PID switch for local control)	Switch 6: On Off	Off Simple Advanced	Simple	Admin
<b>Audio Detect</b>	Switch 3: On Off	On Off	On	Admin
<b>Black Detect</b>	Switch 4: On Off	On Off	On	Admin
<b>Freeze Test/Mode</b>	Switch 5: On Off	Off Clean Source Noisy Source	Off	Admin
<b>Sec Test Enable</b>	On	On Off	On	Admin
<b>Window</b>	Big	Small Big	Big	Admin
<b>Black Time</b>	3 sec	0 – 20 sec	3 sec	Admin
<b>Detect Level</b>	10 IRE	0 – 100 IRE	10 IRE	Admin
<b>Black Fraction</b>	50%	0 – 100%	50%	Admin
<b>Audio Group</b>	Group 1	Group 1 Group 2 Group 3 Group 4	Group 1	Admin
<b>Audio Threshold</b>	-20 VU	0 VU -5 VU -10 VU -15 VU -20 VU -25 VU -30 VU -35 VU -40 VU	-20 VU	Admin
<b>Audio Time</b>	3 sec	.5 – 20 sec	3 sec	Admin
<b>Audio Channel Enable</b>	Enabled Enabled Disabled Disabled	Ch1 enable/disable Ch2 enable/disable Ch3 enable/disable Ch4 enable/disable	Enabled Enabled Disabled Disabled	Admin
<b>Freeze Time</b>	3 sec	0 – 300 sec	3 sec	Admin
<b>Pri GPI Mode</b>	Neg Edge Switch	Off Neg Edge Switch Ext Fault Low Ext Inhibit Low	Neg Edge Switch	Admin

**Model 7460 Serial Digital Protection Switch****7460 Parameter Table (continued)**

<b>CONTROL</b>	<b>LOCAL</b>	<b>REMOTE</b>	<b>DEFAULT</b>	<b>USER LEVEL</b>
<b>Pgm Target</b>	Any	Any Pgm 1 Pgm 2 Pgm 3 Pgm 4	Any	Admin
<b>ASI Time</b>	2 sec	0.1 to 300 sec	2 sec	Admin
<b>Min Vid Rate</b>	100 PIDs	1 to 10,000 PIDs	100 PIDs	Admin
<b>Min Aud Rate</b>	20 PIDs	1 to 10,000 PIDs	20 PIDs	Admin
<b>Memory Registers</b>	Last Saved	1 – 5	Last Saved	Level 1

## Front Panel Controls and Indicators

Each front edge indicator and switch setting of the 7460 is shown in the diagram below:

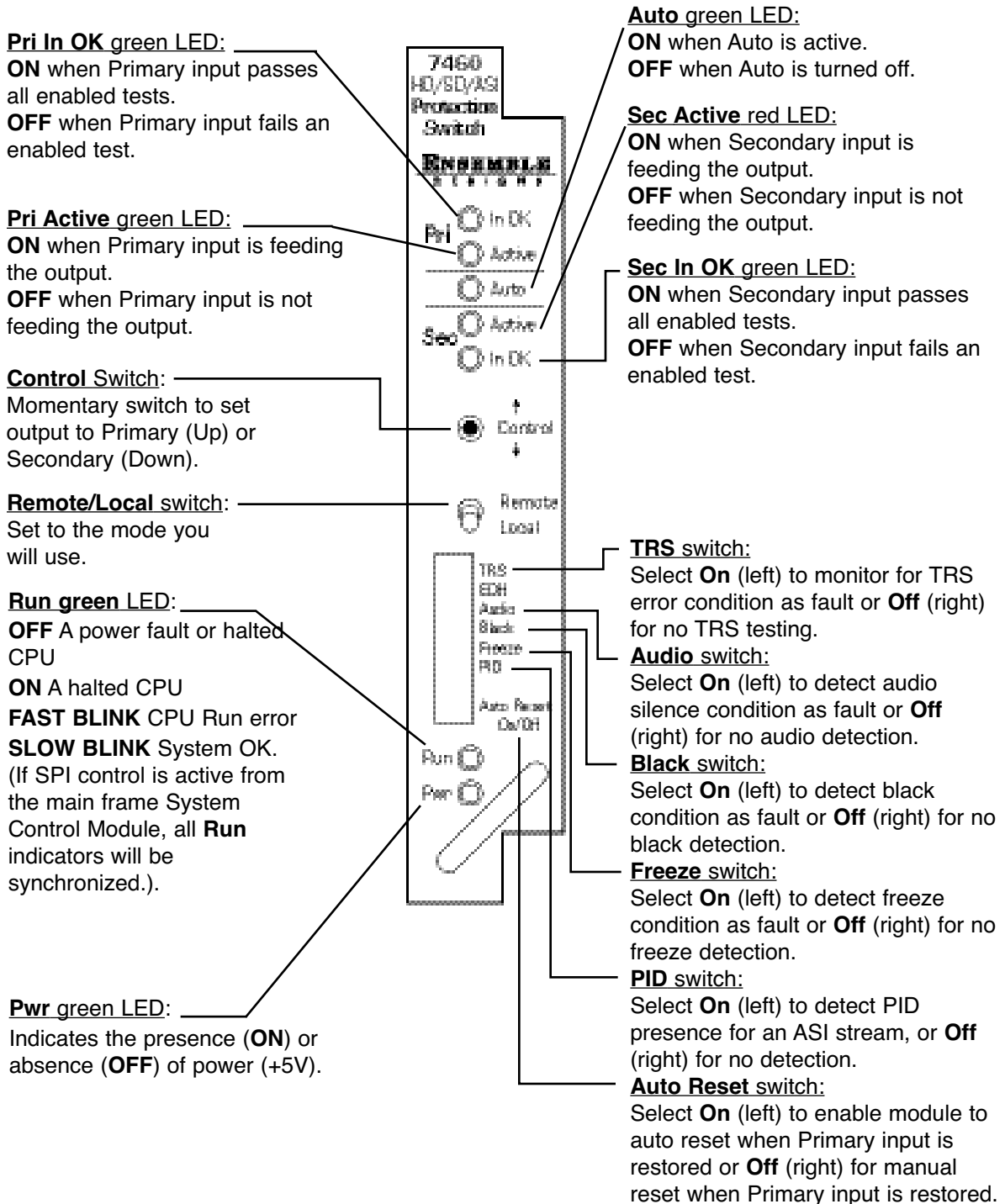

## Avenue PC Remote Configuration

The Avenue PC remote control status menus for the 7460 module are illustrated and explained below. Refer to the **7460 Parameter Table** for a summary of available parameters that can be set remotely through the menus illustrated. For more information on using Avenue PC, refer to the Avenue PC Control Application Software data pack that came with the option.

Parameter fields that are grayed out can indicate one of the following conditions:

- An option is not installed.
- The function is not active.
- The module is locked.
- The User Level set with Avenue PC is not accessible from the current User Level.

### 7460 Avenue PC Menus

The **Status** menu screen shown below displays overall status of selected parameters on both the Primary and Secondary inputs as Green = Good, Red = Bad, Gray = Not enabled. It allows you to set the **Auto Reset** and **Reset Time** controls for the switching function.

- **Pri Status** – shows the status of the Primary Timing Reference Signal (**TRS**), ASI signal present and correct (**ASI**), embedded audio present and correct (**Aud**), black detected as defined in the **Black Detect** menu (**Blk**), and if frozen video is detected as defined in the **Freeze** menu (**Frz**).

The **Pri Status** window on the right will display the status of the Primary and can be monitored with the Avenue PC alarm function.

- **Sec Status** – shows the status of the Secondary input's Timing Reference Signal (**TRS**), ASI signal present and correct (**ASI**), embedded audio present and correct (**Aud**), and black detected as defined in the **Black Detect** menu (**Blk**), and if frozen video is detected as defined in the **Freeze** menu (**Frz**).

The **Sec Status** window on the right will display the status of the Secondary and can be monitored with the Avenue PC alarm function.

Pri Errors	Sec Errors	GPI	Inputs	Memory		
Status	Config	Blk Detect	Aud Detect	Freeze	ASI Config	ASI Status
<b>Pri Status</b> TRS <input checked="" type="checkbox"/> ASI <input type="checkbox"/> Aud <input type="checkbox"/> Blk <input type="checkbox"/> Frz <input type="checkbox"/>					<b>Pri Status</b> Signal Fault	
<b>Sec Status</b> TRS <input checked="" type="checkbox"/> ASI <input type="checkbox"/> Aud <input type="checkbox"/> Blk <input type="checkbox"/> Frz <input type="checkbox"/>					<b>Sec Status</b> Signal Fault	
<b>Pri</b> <input checked="" type="checkbox"/>		<b>Auto</b> <input checked="" type="checkbox"/>		<b>Sec</b> <input type="checkbox"/>		<b>Switch Pos</b> Primary
<b>Auto Reset</b> <input type="text" value="On"/>			<b>Reset Time</b> <input type="button" value="←"/> <input type="button" value="→"/> <input type="text" value="15"/> secs			

- **Switch Pos** – the status window will indicate the current position of the protect switch. This window can be monitored by the Avenue PC alarm function.
- **Pri** – lights green when the Primary input is selected to the output. Click this control to select the Primary as the output.
- **Auto** – lights green when **Auto** is turned on. Switch **Auto** on and off with this switch control. When **Auto** is on, the module will automatically switch to the Secondary input if the Primary fails and the Secondary is good.
- **Sec** – lights red when the Secondary input is selected to the output. Press this switch control to select the Secondary as the output.
- **Auto Reset** – set to **On** or **Off** to determine if the switch will automatically switch back to the Primary after it recovers.
- **Reset Time** – set the amount of time the Primary signal must be good before the auto reset switches back to Primary from Secondary.

The **Config** menu shown below allows you to configure the various condition detectors:

- **TRS Test** – enables the test for any Timing Reference Signal (TRS) errors. **Off** sets the input for no TRS test, **Lenient** allows occasional TRS errors to be ignored (10 frames in a row), or **Strict** detects any TRS error as a fault.
- **ASI Test** – enables the test for ASI signals. **On** detects ASI present as determined by the settings made in the **ASI Config** menu, or **Off** sets the input for no ASI test.
- **Audio Detect** – enables the test for embedded audio. **On** detects an audio condition as determined by the settings made in the **Aud Detect** menu, or **Off** sets the input for no audio test.
- **Black Detect** – enables the test for black detection. **On** detects black present as defined by the settings made in the **Blk Detect** menu, or **Off** sets the input for no black test.
- **Freeze Test** – **On** enables the test for a freeze condition as determined by the settings chosen in the **Freeze** menu. Set to **Off** for no freeze test
- **Sec Test Enable** – enables the test for checking the status of the Secondary input. When **On**, the Secondary status will be checked for the same configuration tests as assigned for the Primary.

Pri Errors		Sec Errors		GPI		Inputs		Memory	
Status	Config	Blk Detect	Aud Detect	Freeze	ASI Config	ASI Status			
TRS Test		ASI Test		Audio Detect					
Lenient		Off		Off					
Black Detect		Freeze Test		Sec Test Enable					
Off		Off		On					

The **Blk Detect** menu shown below allows you to configure the following black detector parameters:

- **Window** – select **Big** or **Small**. **Big** examines nearly the entire raster. **Small** limits the test to a smaller portion of the raster (somewhat smaller than Safe Title limits).
- **Blk Time** – select the amount of time from one frame to 20 seconds that the signal must be continuously in black before the protect switch (and alarm) is generated.
- **Detect Level** – set the video value from 0 to 100 IRE, below which a pixel is considered to be black.
- **Blk Frac** – set the percentage of pixels in the detection window that must satisfy the detection level parameter.

The following status displays are also provided and can be monitored with Avenue PC alarms:

- **Pri Valid** – shows the portion of the Primary input which currently exceeds the **Detect Level** parameter. This display tracks the actual video content.
- **Sec Valid** – shows the portion of the Secondary input which currently exceeds the **Detect Level** parameter. This display tracks the actual video content.

The screenshot shows the 'Blk Detect' configuration menu within the Avenue PC interface. The menu is organized into several sections:

- Navigation Tabs:** Pri Errors, Sec Errors, GPI, Inputs, Memory (top row); Status, Config, Blk Detect, Aud Detect, Freeze, ASI Config, ASI Status (second row).
- Window:** A dropdown menu currently set to 'Big'.
- Blk Time:** A control with left and right arrow buttons and a numeric input field set to '3' with the unit 'secs'.
- Detect Level:** A control with left and right arrow buttons and a numeric input field set to '10' with the unit 'IRE'.
- Blk Frac:** A control with left and right arrow buttons and a numeric input field set to '5' with the unit 'pcnt'.
- Pri Valid:** A control with a numeric input field set to '0' and the unit 'pcnt'.
- Sec Valid:** A control with a numeric input field set to '0' and the unit 'pcnt'.

The **Aud Detect** menu shown below allows you to configure the following audio parameters:

- **Audio Group** – select which embedded audio group (**Group 1 – 4**) to detect.
- **Aud Thrsh** – select the silence detection level from 0 VU to –40 VU.

**Note:** An audio signal level of 0 VU corresponds to -20dBFs and is the generally accepted digital reference level for AES audio. The 7460 uses the standard weighting and ballistics of VU (Volume Unit) measurement rather than decibel-based measurement in order to more closely represent audio levels as perceived by the listener.

- **Audio Time** – set the time that the channels must be continuously silent before an alarm is triggered (0 – 20 seconds). Note that a loss of embedded audio will cause an immediate switch, regardless of this setting.
- **Ch1, Ch2, Ch3, Ch4** – enable or disable Channels 1 – 4. Each embedded group contains four audio channels. Sensing for each channel can be enabled separately.

The following status displays are also provided:

- **Pri Status** – shows the status of the four audio channels embedded in the Primary signal. Green indicates Channel OK, red indicates silence, and gray indicates channel not enabled. An **OK** indicator shows the overall result of the test for all the channels enabled.
- **Sec Status** – shows the status of the four audio channels embedded in the Secondary signal. Green indicates Channel OK, red indicates silence, and gray indicates channel not enabled. An **OK** indicator shows the overall result of the test for all the channels enabled.
- **Pri Aud Status** – shows the overall status of the audio channels embedded in the Primary signal. This window can be monitored by the Avenue PC alarm function.

The screenshot displays the 'Aud Detect' configuration and status interface. At the top, there are several tabs: 'Pri Errors', 'Sec Errors', 'GPI', 'Inputs', and 'Memory'. Below these are sub-tabs: 'Status', 'Config', 'Blk Detect', 'Aud Detect' (selected), 'Freeze', 'ASI Config', and 'ASI Status'. The main interface is divided into several sections:

- Audio Group:** A dropdown menu set to 'Group 1'.
- Aud Thrsh:** A dropdown menu set to '-20 VU'.
- Audio Time:** A numeric input field set to '3' with 'secs' to its right, and left/right arrow buttons for adjustment.
- Channel Status (Ch1-Ch4):** Four square indicators. Ch1 and Ch2 are green, Ch3 and Ch4 are gray.
- Pri Status:** Four square indicators for Ch1 (green), Ch2 (green), Ch3 (gray), Ch4 (gray), and an 'OK' indicator (green).
- Sec Status:** Four square indicators for Ch1 (red), Ch2 (red), Ch3 (gray), Ch4 (gray), and an 'OK' indicator (red).
- Pri Aud Status:** A text box containing the word 'Good'.

## Model 7460 Serial Digital Protection Switch

---

The **Freeze** menu shown below allows you to configure the following parameters for a video freeze condition:

- **Freeze Mode** – set the freeze detection to **Clean Source**, **Noisy Source**, or **Off**.
- **Freeze Time** – set the amount of time in seconds for the protect switch to switch to the Secondary input after a video freeze condition is detected.

The following status indicators can be monitored by Avenue PC alarm functions.

- **Pri Frz Status** – indicates the freeze status of the Primary as **Frozen** or **Un-Frozen**.
- **Sec Frz Status** – indicates the freeze status of the Secondary as **Frozen** or **Un-Frozen**.

**Note:** If either **Noisy Source** or **Clean Source** are selected, and Freeze test is set to **Off** in the **Configuration** menu, use of Avenue PC alarms is allowed without activating a switch to the Secondary Source. Primary and Secondary Freeze Error Counts are then active.

The screenshot shows the 'Freeze' configuration window. At the top, there are tabs for 'Pri Errors', 'Sec Errors', 'GPI', 'Inputs', and 'Memory'. Below these are sub-tabs: 'Status', 'Config', 'Blk Detect', 'Aud Detect', 'Freeze', 'ASI Config', and 'ASI Status'. The 'Freeze' sub-tab is active. The 'Freeze Mode' is set to 'Clean Source' in a dropdown menu. The 'Freeze Time' is set to '3' seconds, with left and right arrow buttons for adjustment. The 'Pri Frz Status' is 'Frozen' and the 'Sec Frz Status' is also 'Frozen'.

The **ASI Config** menu shown below allows you to configure the following parameters:

- **Pgm Target** – looks for PMTs in the ASI stream. Select **Any**, **Pgrm 1**, **Pgrm 2**, **Pgrm 3**, or **Pgrm 4**. When **Any** is selected, a PMT in any program stream will define the input as good.
- **ASI Time** – select the amount of time from 0.1 to 30 seconds that any enabled ASI errors are continuously undetected before the protect switch (and alarm) is generated. A setting of between 2 - 5 seconds is recommended for most applications.
- **Min Vid Rate** – set the video value from 1 to 10,000 video PIDs, below which the protect switch (and alarm) is generated.
- **Min Aud Rate** – set the audio value from 1 to 10,000 audio PIDs, below which the protect switch (and alarm) is generated.

The following status displays are also provided:

- **Pri ASI Status** – displays the status of the Primary and can be monitored with the Avenue PC alarm function.
- **Sec ASI Status** – displays the status of the Secondary and can be monitored with the Avenue PC alarm function.

Pri Errors		Sec Errors		GPI		Inputs		Memory	
Status	Config	Blk Detect	Aud Detect	Freeze	ASI Config	ASI Status			
Pgm Target									
<input type="text" value="Any"/>									
ASI Time			Min Vid Rate			Min Aud Rate			
<input type="text" value="2"/> secs			<input type="text" value="100"/> PIDs			<input type="text" value="20"/> PIDs			
Pri ASI Status					Sec ASI Status				
<input type="text" value="Good"/>					<input type="text" value="No ASI"/>				

The **ASI Status** menu shown below displays the status of the following parameters:

- **Pri ASI Status** – displays the status of the Primary input and can be monitored with the Avenue PC alarm function.
- **Sec ASI Status** – displays the status of the Secondary input and can be monitored with the Avenue PC alarm function.
- **PAT per Sec** – displays the number of Program Allocation Tables detected per second for the Primary input.
- **PMT per Sec** – displays the number of Program Management Tables detected per second for the Primary input.
- **PCR per Sec** – displays the number of Program Clock References detected per second for the Primary input.
- **Vid per Sec** – displays the number of video PIDs detected per second for the Primary input.
- **Aud per Sec** – displays the number of audio PIDs detected per second for the Primary input.
- **Packet Length** – displays the detected packet length per second for the Primary input.

Pri Errors		Sec Errors		GPI	Inputs	Memory
Status	Config	Blk Detect	Aud Detect	Freeze	ASI Config	ASI Status
Pri ASI Status		Sec ASI Status				
Good		No ASI				
PAT per Sec		PMT per Sec		PCR per Sec		
0		0		0		
Vid per Sec		Aud per Sec		Packet Length		
0		0		188		

## Model 7460 Serial Digital Protection Switch

The **Pri Errors** menu shown below displays the amount of time in seconds that each of the error conditions have been present after detection on the Primary as well as the number of times the Primary feed has switched to the Secondary feed (**Sec Sw Cnt**).

The error counters display the number of *cumulative* errors that have occurred since a counter was last reset. Errors may occur as a single event, or as multiple events over a period of time. Refer to the Avenue PC manual to learn how to use the alarms and logging capabilities of Avenue PC to obtain more detailed information on errors.

The upper limit for cumulative errors is 10,000. If an error counter reaches this upper limit, it will repeatedly cycle between 10,000 and 9,990. To reset the error counter, double-click it.

Status	Config	Blk Detect	Aud Detect	Freeze	ASI Config	ASI Status
Pri Errors	Sec Errors	GPI	Inputs	Memory		
TRS ErrSec 2801 Cnt	BLK ErrSec 2801 Cnt	AUD ErrSec 2801 Cnt				
ASI ErrSec 0 Cnt	ASI Vid ErrSec 0 Cnt	ASI Aud ErrSec 0 Cnt				
FRZ ErrSec 2800 Cnt	Sec Sw Cnt 8 Cnt					

## Model 7460 Serial Digital Protection Switch

The **Sec Errors** menu shown below displays the amount of time in seconds that each of the enabled error conditions have been present after detection on the Secondary as well as the number of times the Primary feed has switched to the Secondary feed (**Sec Sw Cnt**).

Status	Config	Blk Detect	Aud Detect	Freeze	ASI Config	ASI Status
Pri Errors	Sec Errors	GPI	Inputs	Memory		
TRIS ErrSec 0 Cnt	BLK ErrSec 0 Cnt	AUD ErrSec 0 Cnt	ASI ErrSec 2867 Cnt	ASI Vid ErrSec 1 Cnt	ASI Auf ErrSec 1 Cnt	
FRZ ErrSec 0 Cnt	Sec Sw Cnt 8 Cnt					

The 7460 can be set up to allow an external device to trigger a switch through the GPI interface. The **GPI** menu screen shown below allows configuration of the two external GPI inputs to the module.

The Primary and Secondary GPI Modes can be set to one of the following:

- **Off** – disables the GPI input.
- **Neg Edge Switch** – switches on a low-going transition to the GPI input.
- **Ext Fault Low** – acts in conjunction with the status of the input signal to the module. In this case, a loss of proper signal to the module or a low signal detected from an external device will close the switch.
- **Ext Inhibit Low** – acts to prevent a switch regardless of the status of the input signal to the module. In this case, a loss of proper signal will not cause a switch.

Status of the Pri GPI and Sec GPI inputs are indicated as **GPI is Low** or **GPI is High** in the **Pri GPI** and **Sec GPI Status** window.

Status	Config	Blk Detect	Aud Detect	Freeze	ASI Config	ASI Status
Pri Errors	Sec Errors	GPI	Inputs	Memory		
Pri GPI Mode Neg Edge Switch	Pri GPI Status GPI is High					
Sec GPI Mode Neg Edge Switch	Sec GPI Status GPI is High					

The **Inputs** menu displays the type of signal detected on the Primary and Secondary inputs.

- **Primary Input** displays the signal type detected on the Primary Input connector, SD-SDI, HD-SDI, or ASI.
- **Secondary Input** displays the signal type detected on the Secondary Input connector, SD-SDI, HD-SDI, or ASI.

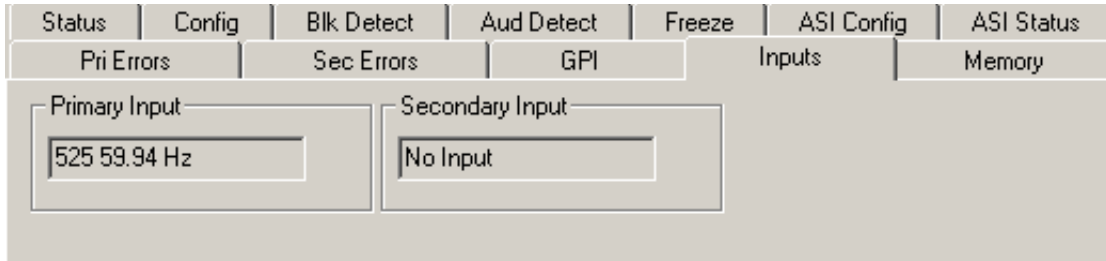

The **Memory** menu allows you to save and recall up to 5 different setups for the 7460 module as follows:

- Click **Save**, then one of the five memory registers **Reg 1 – 5**. The box will turn green. The entire module setup is now saved in the selected register.
- To recall a setup, click the register box. If there is information saved, the box will turn green. The saved setup will load into the module.

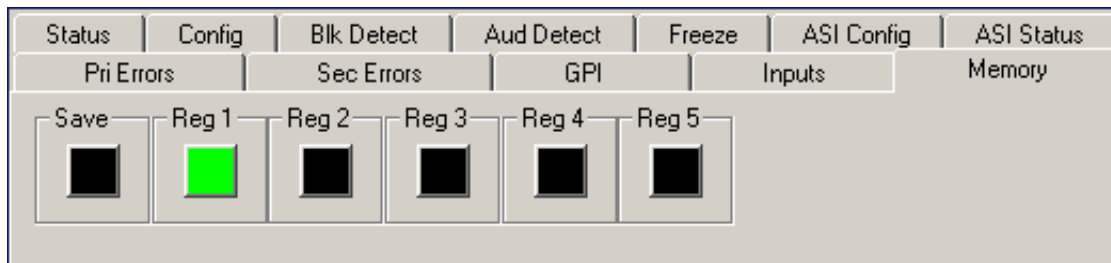

## Avenue Touch Screen Remote Configuration

The Avenue Touch Screen remote control status menus for this module are illustrated and explained below. Refer to the **7460 Parameter Table** for a summary of available parameters that can be set remotely through the menus illustrated. For more information on using Avenue Touch Screen, refer to the Avenue Touch Screen data pack.

Parameter fields that are grayed out can indicate one of the following conditions:

- An option is not installed.
- The function is not active.
- The module is locked.
- The User Level set with Avenue PC is not accessible from the current User Level.

### 7460 Avenue Touch Screen Menus

The **Status** menu displays the overall status of selected parameters on both the Primary and Secondary inputs as Green = Good, Red = Bad, Gray = Not enabled. It also allows you to set the Auto Reset and Reset Time controls for the switching function.

- **Pri Status** – shows the status of the Primary Timing Reference Signal (**TRS**), ASI signal present and correct (**ASI**), embedded audio present and correct (**Aud**), black detected as defined in the **Black Detect** menu (**Blk**), and if frozen video is detected as defined in the **Freeze** menu (**Frz**).
- **Sec Status** – shows the status of the Secondary Timing Reference Signal (**TRS**), ASI signal present and correct (**ASI**), embedded audio present and correct (**Aud**), and black detected as defined in the **Black Detect** menu (**Blk**), and if frozen video is detected as defined in the **Freeze** menu (**Frz**).
- **Pri** – lights green when the Primary input is selected to the output. Press this control to select the Primary as the output.
- **Auto** – lights green when **Auto** is turned on. Switch **Auto** on and off with this switch control. When **Auto** is on, the module will automatically switch to the Secondary input if the Primary fails and the Secondary is good.
- **Sec** – lights red when the Secondary input is selected to the output. Press this switch control to select the Secondary as the output.
- **Auto Reset** – set to **On** or **Off** to determine if the switch will automatically switch back to the Primary after it recovers.
- **Reset Time** – set the amount of time the Primary signal must be good before the auto reset switches back to Primary from Secondary.

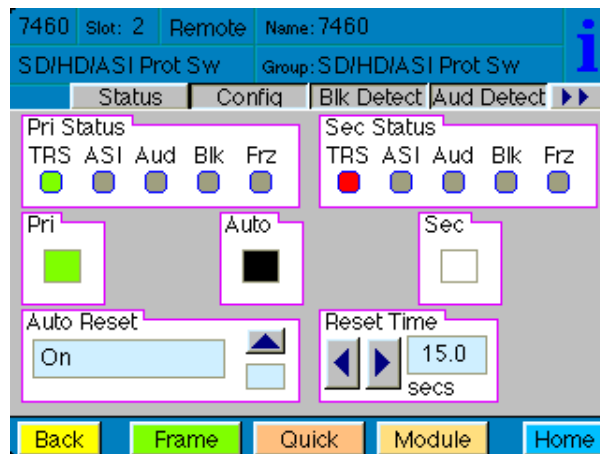

The **Config** menu shown below allows you to configure the various condition detectors:

- **TRS Test** – enable the test for any Timing Reference Signal (TRS) errors. **Off** sets the input for no TRS test, **Lenient** allows occasional TRS errors to be ignored, or **Strict** detects any TRS error as a fault.
- **ASI Test** – enables the test for ASI signals. **On** detects ASI present as determined by the settings made in the **ASI Config** menu, or **Off** sets the input for no ASI test.
- **Audio Detect** – enable the test for embedded audio. **On** detects an audio condition as determined by the settings made in the **Aud Detect** menu, or **Off** sets the input for no audio test.
- **Black Detect** – enable the test for black detection. **On** detects black present as defined by the settings made in the **Blk Detect** menu, or **Off** sets the input for no black test.
- **Freeze Test** – **On** enables the test for a freeze condition as determined by the settings chosen in the **Freeze** menu. Set to **Off** for no freeze test.
- **Sec Test Enable** – enable the test for checking the status of the Secondary input. When **On**, the Secondary status will be checked for the same configuration tests as assigned for the Primary.

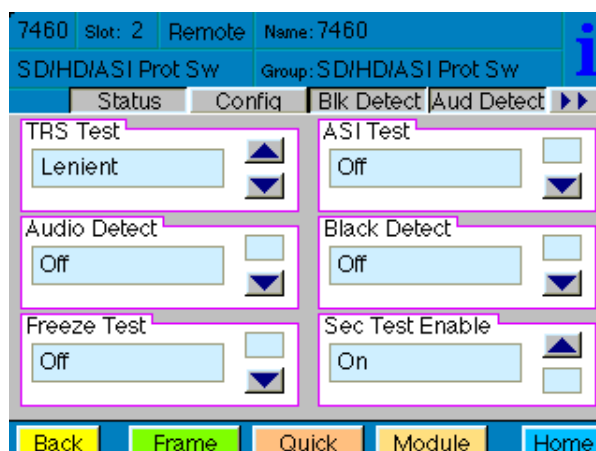

The **Blk Detect** menu shown below allows you to configure the following black detector parameters:

- **Window** – select **Big** or **Small**. **Big** examines nearly the entire raster. **Small** limits the test to a smaller portion of the raster (somewhat smaller than Safe Title limits).
- **Blk Time** – select the amount of time from one frame to 20 seconds that the signal must be continuously in black before the protect switch (and alarm) is generated.
- **Detect Level** – set the video value from 0 to 100 IRE, below which a pixel is considered to be black.
- **Blk Frac** – set the percentage of pixels in the detection window that must satisfy the detection level parameter.

The following status displays are also provided:

- **Pri Valid** – shows the portion of the Primary input which currently exceeds the Detect Level parameter. This display tracks the actual video content.
- **Sec Valid** – shows the portion of the Secondary input which currently exceeds the Detect Level parameter. This display tracks the actual video content.

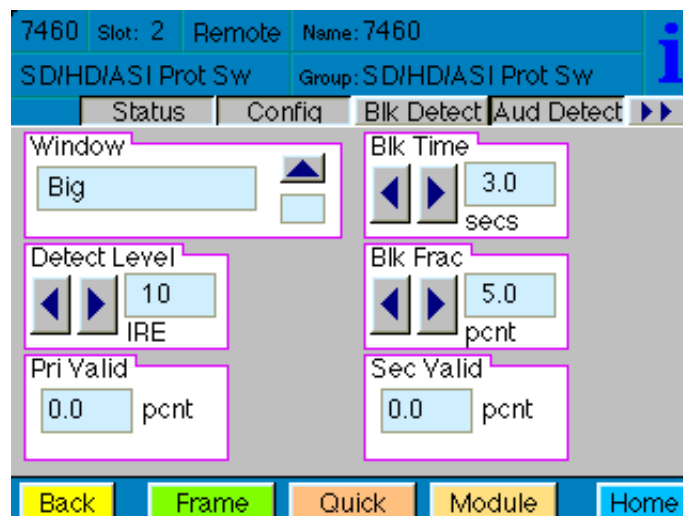

The **Aud Detect** menu shown below allows you to configure the following audio parameters:

- **Audio Group** – select which embedded audio group (**Group 1 – 4**) to detect.
- **Aud Thrsh** – select the silence detection level from 0 VU to –40 VU.

**Note:** An audio signal level of 0 VU corresponds to -20dBFs and is the generally accepted digital reference level for AES audio. The 7460 uses the standard weighting and ballistics of VU (Volume Unit) measurement rather than decibel-based measurement in order to more closely represent audio levels as perceived by the listener.

- **Audio Time** – set the time that the channels must be continuously silent before an alarm is triggered (0 – 20 seconds). Note that a loss of embedded audio will cause an immediate switch, regardless of this setting.
- **Ch1, Ch2, Ch3, Ch4** – enable or disable Channels 1 – 4. Each embedded group contains four audio channels. Sensing for each channel can be enabled separately.

The following status displays are also provided:

- **Pri Status** – shows the status of the four audio channels embedded in the Primary signal. Green indicates Channel OK, red indicates silence, and gray indicates channel not enabled. An **OK** indicator shows the overall result of the test for all the channels enabled.
- **Sec Status** – shows the status of the four audio channels embedded in the Secondary signal. Green indicates Channel OK, red indicates silence, and gray indicates channel not enabled. An **OK** indicator shows the overall result of the test for all the channels enabled.

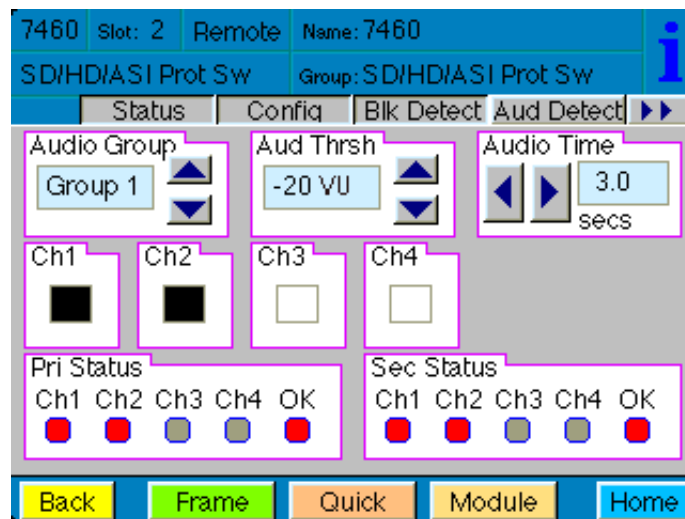

## Model 7460 Serial Digital Protection Switch

---

The **Freeze** menu shown below allows you to configure the following parameter for a video freeze condition:

- **Freeze Mode** – set the freeze detection for **Clean Source**, **Noisy Source**, or **Off**.
- **Freeze Time** – set the amount of time in seconds for the protect switch to switch to the Secondary input after a video freeze condition is detected.

The following indicators give Primary and Secondary freeze status:

- **Pri Frz Status** – indicates the freeze status of the Primary as **Frozen** or **Un-Frozen**.
- **Sec Frz Status** – indicates the freeze status of the Secondary as **Frozen** or **Un-Frozen**.

**Note:** If either **Noisy Source** or **Clean Source** are selected, with Freeze test set to **Off** in the Configuration menu, use of Avenue PC alarms is allowed without activating a switch to the Secondary Source. Primary and Secondary Freeze Error Counts are then active.

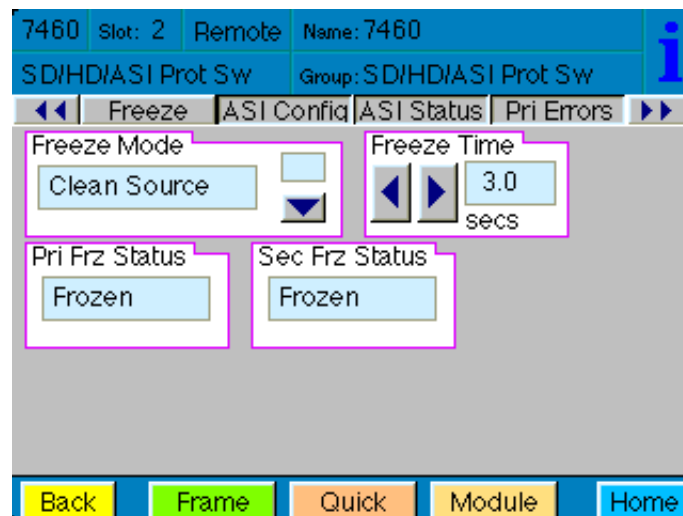

The **ASI Config** menu shown below allows you to configure the following parameters:

- **Pgm Target** – looks for PMTs in the ASI stream. Select **Any**, **Pgrm 1**, **Pgrm 2**, **Pgrm 3**, or **Pgrm 4**. When **Any** is selected, a PMT in any program stream will define the input as good.
- **ASI Time** – select the amount of time from 0.1 to 30 seconds that any enabled ASI errors are continuously undetected before the protect switch (and alarm) is generated. A setting of between 2 - 5 seconds is recommended for most applications.
- **Min Vid Rate** – set the video value from 1 to 10,000 video PIDs, below which the protect switch (and alarm) is generated.
- **Min Aud Rate** – set the audio value from 1 to 10,000 audio PIDs, below which the protect switch (and alarm) is generated.

The following status displays are also provided:

- **Pri ASI Status** – displays the status of the Primary and can be monitored with the Avenue PC alarm function.
- **Sec ASI Status** – displays the status of the Secondary and can be monitored with the Avenue PC alarm function.

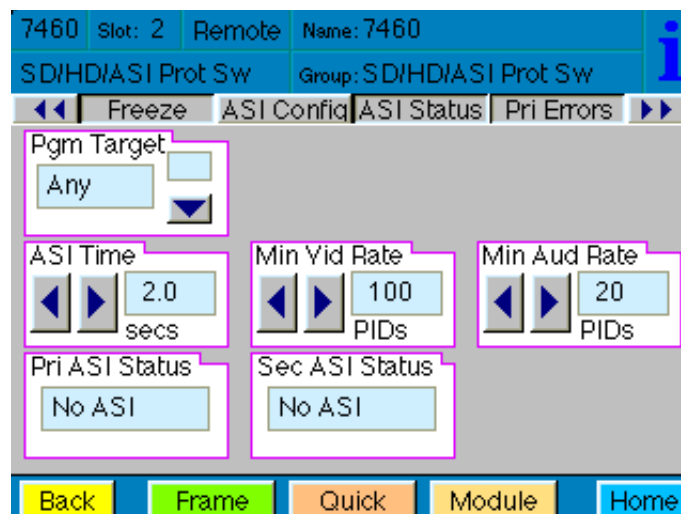

The **ASI Status** menu shown below displays the status of the following parameters:

- **Pri ASI Status** – displays the status of the Primary input and can be monitored with the Avenue PC alarm function.
- **Sec ASI Status** – displays the status of the Secondary input and can be monitored with the Avenue PC alarm function.
- **PAT per Sec** – displays the number of Program Allocation Tables detected per second for the Primary input.
- **PMT per Sec** – displays the number of Program Management Tables detected per second for the Primary input.
- **PCR per Sec** – displays the number of Program Clock References detected per second for the Primary input.
- **Vid per Sec** – displays the number of video PIDs detected per second for the Primary input.
- **Aud per Sec** – displays the number of audio PIDs detected per second for the Primary input.
- **Packet Length** – displays the detected packet length per second for the Primary input.

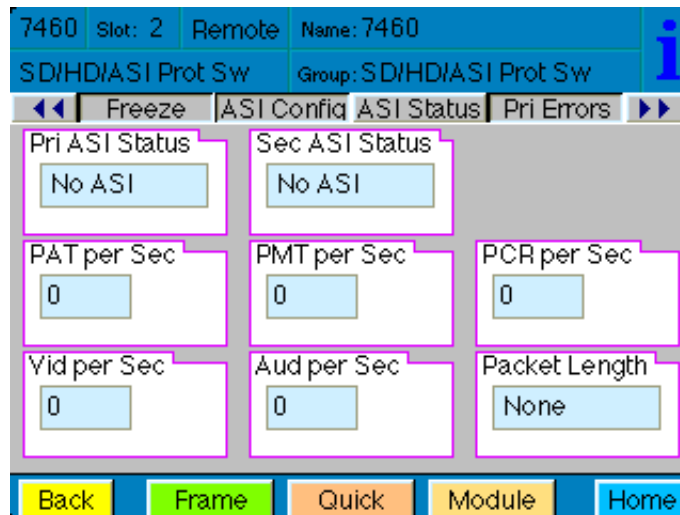

The **Pri Errors** menu shown below displays the amount of time in seconds that each of the error conditions have been present after detection on the Primary as well as the number of times the Primary feed has switched to the Secondary feed (**Sec Sw Cnt**).

The error counters display the number of *cumulative* errors that have occurred since a counter was last reset. Errors may occur as a single event, or as multiple events over a period of time. Refer to the Avenue PC manual to learn how to use the alarms and logging capabilities of Avenue PC to obtain more detailed information on errors.

The upper limit for cumulative errors is 10,000. If an error counter reaches this upper limit, it will repeatedly cycle between 10,000 and 9,999. To reset the error counter, double-click it.

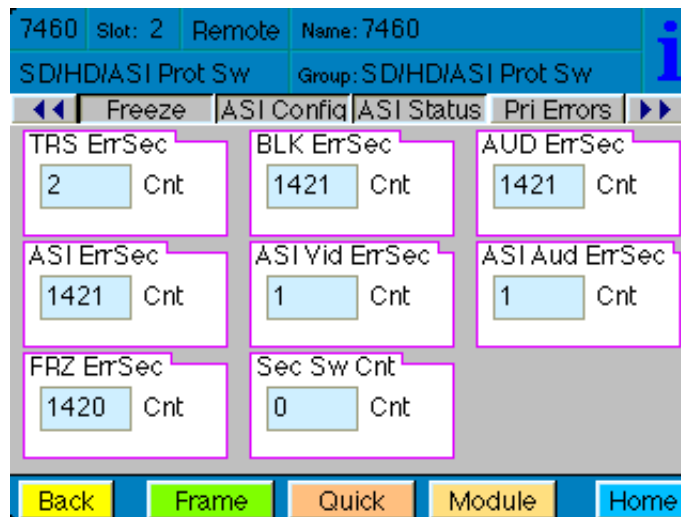

## Model 7460 Serial Digital Protection Switch

The **Sec Errors** menu shown below displays the amount of time in seconds that each of the enabled error conditions have been present after detection on the Secondary and the number of times the Primary has switched to the Secondary (**Sec Sw Cnt**).

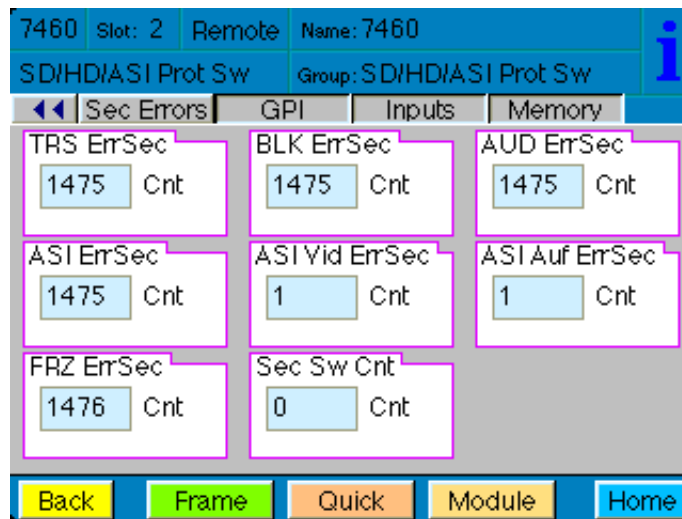

## Model 7460 Serial Digital Protection Switch

The 7460 can be set up to allow an external device to trigger a switch through the GPI interface. The **GPI** menu screen shown below allows configuration of the two external GPI inputs to the module.

The Primary and Secondary GPI Modes can be set to one of the following:

- **Off** – disables the GPI input.
- **Neg Edge Switch** – switches on a low-going transition to the GPI input.
- **Ext Fault Low** – acts in conjunction with the status of the input signal to the module. In this case, a loss of proper signal to the module or a low signal detected from an external device will close the switch.
- **Ext Inhibit Low** – acts to prevent a switch regardless of the status of the input signal to the module. In this case, a loss of proper signal will not cause a switch.

Status of the Pri GPI and Sec GPI inputs are indicated as **GPI is Low** or **GPI is High** in the **Pri GPI** and **Sec GPI Status** window.

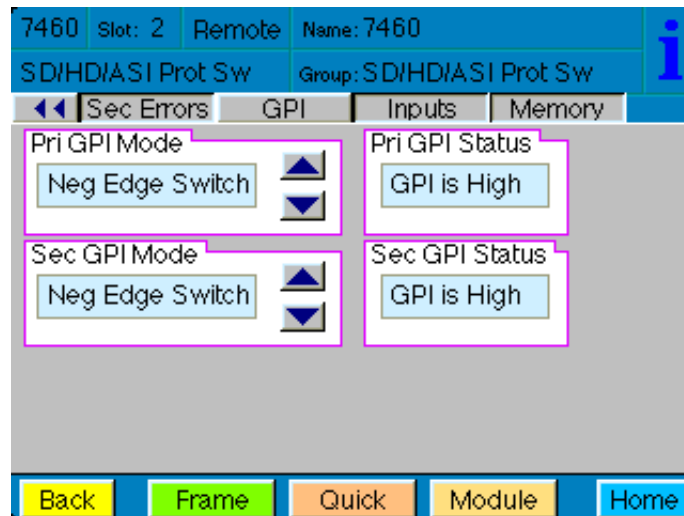

The **Inputs** menu displays the type of signal detected on the Primary and Secondary inputs.

- **Primary Input** displays the signal type detected on the Primary Input connector, SD-SDI, HD-SDI, or ASI.
- **Secondary Input** displays the signal type detected on the Secondary Input connector, SD-SDI, HD-SDI, or ASI.

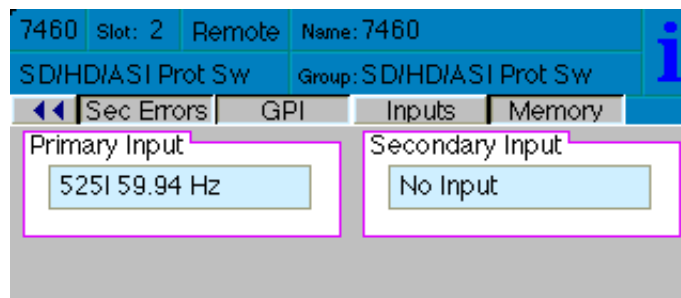

## Model 7460 Serial Digital Protection Switch

---

The **Memory** menu allows you to save and recall up to 5 different setups for the 7460 module as follows:

- Select **Save**, then one of the five memory registers **Reg 1 – 5**. The box will turn green. The entire module setup is now saved in the selected register.
- To recall a setup, select the register box. If there is information saved, the box will turn green. The saved setup will load into the module.

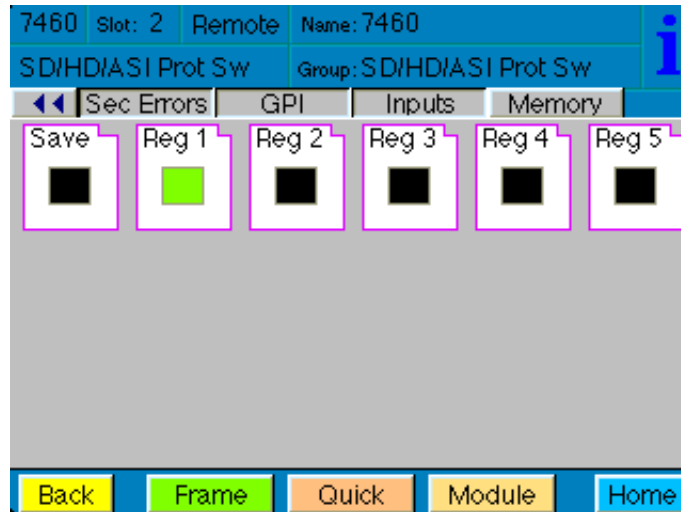

## TROUBLESHOOTING

As a troubleshooting aid, reference signal status and presence, as well as power and CPU status can be easily monitored from the front panel of the 7460 module using the front panel indicators.

Refer to the troubleshooting tips below:

### **Can't control module:**

- Check status of CPU **Run** green LED. Should be blinking slowly and in unison with other modules if System module is present. If not, try removing it and plugging it in again to be sure it is seated properly.
- System module may not be working properly if installed.

### **Module remote controls are grayed out:**

- Module is locked or access to module controls is restricted by User Level.

### **No signal out of module:**

- Check status of **Active** LEDs. Primary or Secondary should be lit. If not, check the inputs for signal presence and quality.
- Check cabling to input of the module.

Please also refer to the technical support section of the Ensemble Designs web site for the latest information on your equipment at the URL below:

<http://www.ensembledesigns.com/support>

## SOFTWARE UPDATES

Software updates for each module can be downloaded remotely if the optional System Control module is installed. These can be downloaded onto your PC, then Avenue PC will distribute the update to the individual module. (Refer to the Avenue PC documentation for more information) Updates are periodically posted on the Ensemble Designs web site. If you do not have the required System Control Module and Avenue PC, modules can be sent back to the factory for software upgrades.

## **WARRANTY AND FACTORY SERVICE**

### **Warranty**

This module is covered by a five year limited warranty, as stated in the main Preface of this manual. If you require service (under warranty or not), please contact Ensemble Designs and ask for customer service before you return the unit. This will allow the service technician to provide any other suggestions for identifying the problem and recommend possible solutions.

### **Factory Service**

If you return equipment for repair, please get a Return Material Authorization Number (RMA) from the factory first.

Ship the product and a written description of the problem to:

Ensemble Designs, Inc.  
Attention: Customer Service RMA #####  
870 Gold Flat Rd.  
Nevada City, CA. 95959 USA  
(530) 478-1830  
Fax: (530) 478-1832  
service@ensembledesigns.com  
<http://www.ensembledesigns.com>

Be sure to put your RMA number on the outside of the box.

## SPECIFICATIONS

### 7460 Serial Digital Protection Switch

#### **Input Signal:**

Number: Two  
Signal Type: HD Serial Digital (SMPTE 274M, 292M, or 296M)  
or SD Serial Digital 270 Mb/s (SMPTE 259M)  
or DVB-ASI 270 Mb/s

Standard: 1080i 50/59.94/60  
720p 50/59.94/60  
1080p 23.98/24/25  
1080sF 23.98/24/25  
625i 50  
525i 59.94  
DVB - ASI  
auto detect

Impedance: 75  $\Omega$   
Return Loss: > 15 dB to 270 MHz

#### **Serial Digital Loopback:**

Number: Two total  
One primary  
One secondary  
Impedance: 75  $\Omega$

#### **Serial Output Signal:**

Number: Six total  
One Fail-safe bypass output  
Five outputs

Signal Type: Follows Selected Input  
Impedance: 75  $\Omega$

#### **General Specifications:**

Connectors: BNC  
Power Consumption: < 7.0 Watts  
Temperature Range: 0 to 40 degrees C ambient (all specs met)  
Relative Humidity: 0 to 95% noncondensing  
Altitude: 0 to 10,000 ft  
Fusing: 4ea 0.75 Amp PTC resettable fuse with  
each domain of the module independently regulated.

Due to ongoing product development, all specifications subject to change.

